DATA SHEET

SD1010A

**Analog-Interface XGA TFT
LCD Display Controller**

November 1999

SD1010A DATA SHEET
DAT-SD1010-1199-B

November 1999

Document	Revisions	Date
DAT-SD1010-1099-A	SD1010 Data Sheet - A	October 1999
DAT-SD1010-1199-B	SD1010 Data Sheet - B	November 1999

Copyright 1999, SmartASIC, Inc. All Right Reserved

SmartASIC, Inc. reserves the right to change or modify the information contained herein without notice. It is the customer's responsibility to ensure he/she has the most recent revision of the user guide. SmartASIC, Inc. makes no warranty for the use of its products and bears no responsibility for any error or omissions, which may appear in this document.

1. OVERVIEW

The SD1010A is enhanced version of the SD1000 chip. It is an IC designed for analog-interface XGA TFT LCD monitors. An analog-interface LCD monitor takes analog RGB signals from a graphic card of a personal computer, the exact same input interface as a conventional CRT monitor. This feature makes analog-interface LCD monitor a true replacement of a conventional CRT monitor.

The analog input RGB signals are first sampled by three channels of 8-bit A/D converters, and the 24-bit RGB data are then fed into the SD1010A. The SD1010A is capable of performing automatic detection of the display resolution and timing of input signals generated from various PC graphic cards. No special driver is required for the timing detection, nor any manual adjustment. The SD1010A then automatically scales the input image to fill the full screen of the LCD monitor. The SD1010A can interface with TFT LCD panels from various manufacturers by generating either 24-bit or 48-bit RGB signal to the LCD panel based upon the timing parameters saved in the EEPROM.

The SD1010A implements four advanced display technologies:

1. Advanced mode detection and auto-calibration without any external CPU assist
2. Advanced programmable interpolation algorithm
3. Stand-alone mode support, and
4. Advanced true color support with both dithering and frame modulation.

The SD1010A also provides distinguished system features to the TFT LCD monitor solution. The first one is “plug-and-play”, and the second one is “cost-effective system solution”. To be truly plug-and-display, the SD1010A performs automatic input mode detection and auto phase calibration, so the LCD monitor can ensure that the A/D converters’ sample clock is precisely synchronized with the input video data, and to preserve the highest image bandwidth for the highest image quality. Furthermore, the SD1010A can generate output video even when the input signal is beyond the specifications or no input signal is fed.

For “cost-effective system solution”, the SD1010A implements many system support features such as OSD mixer, error status indicators, 2-wire serial interface for both EEPROM and host CPU interface, and low-cost IC package. Another important contributing factor is that the SD1010A does not require external frame buffer memory for the automatic image scaling and synchronization.

Figure 1 shows the block diagram of the SD1010A as well as the connections of important system components around the SD1010A.

Figure 1: SD1010A Functional Block Diagram

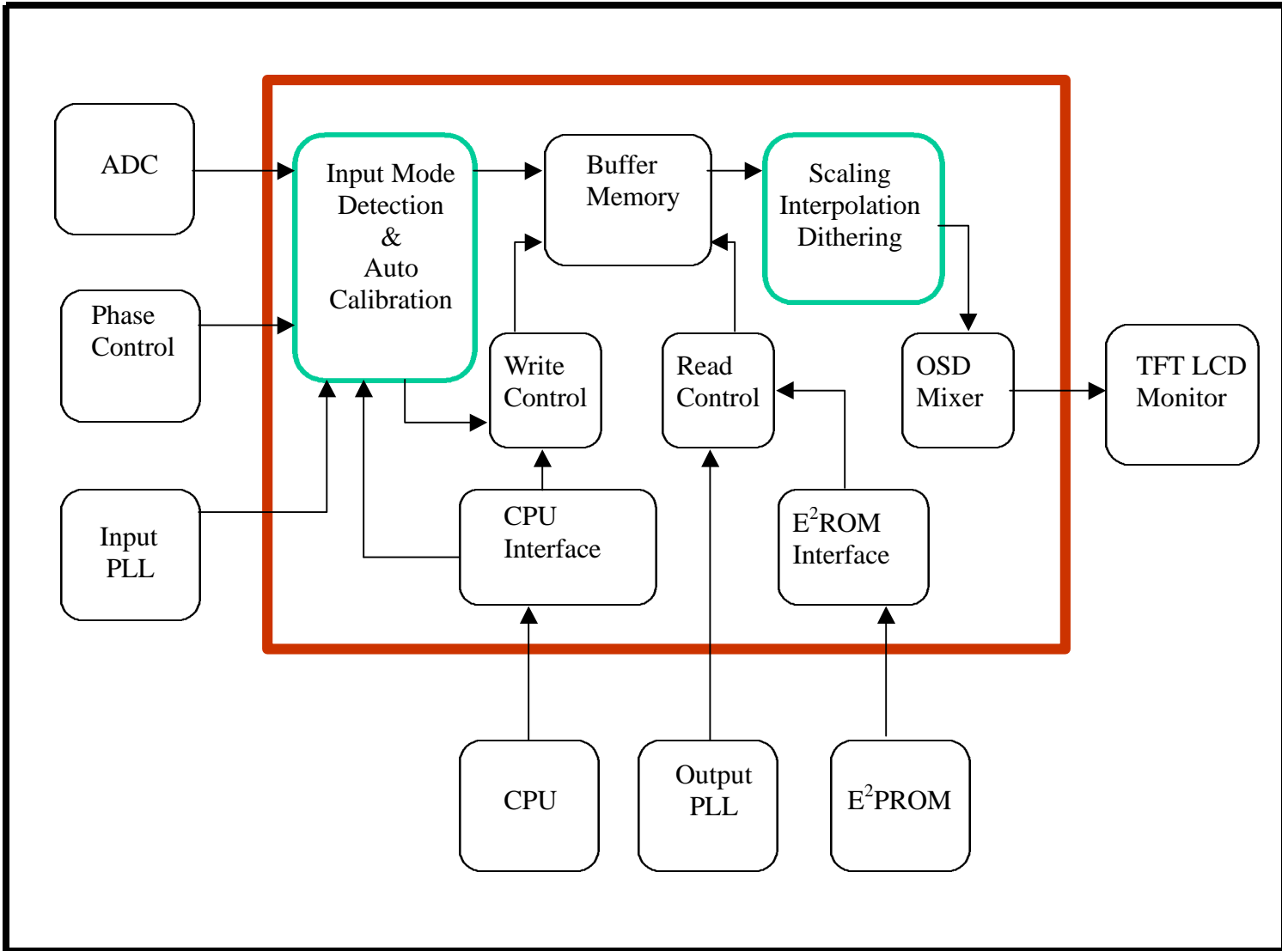

2. PIN DESCRIPTION

Figure 2: SD1010A package diagram

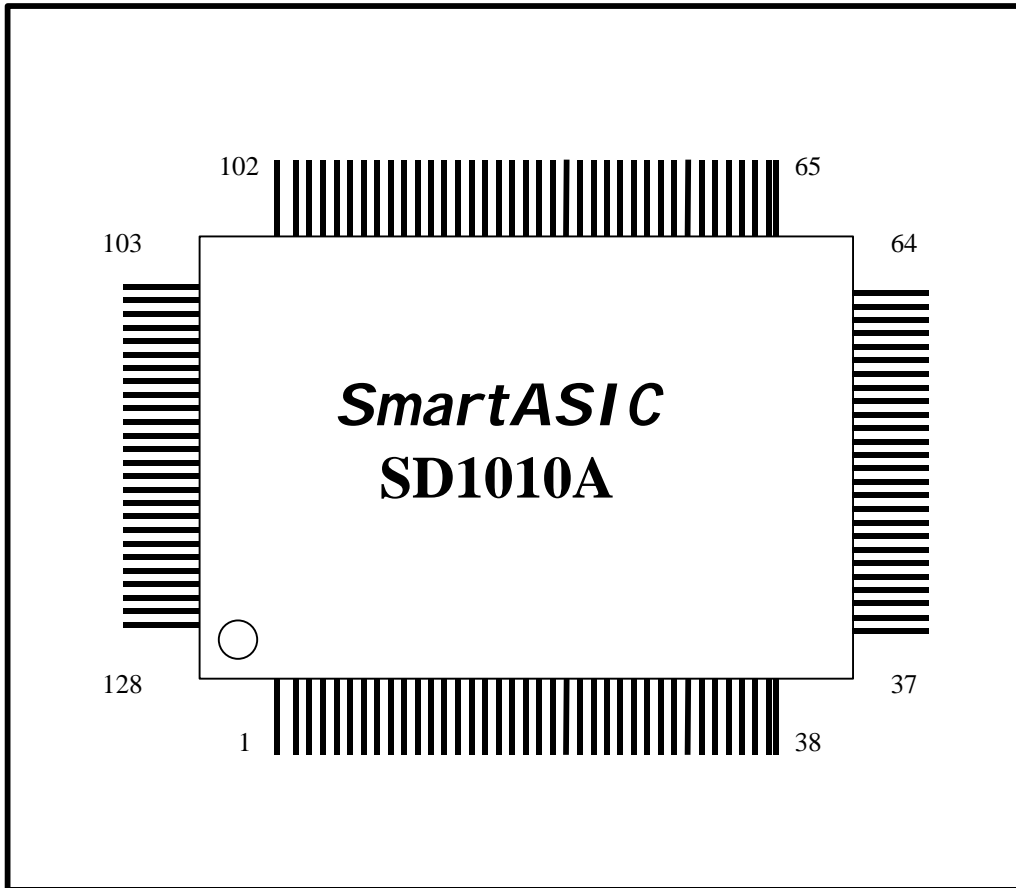

Table 1: SD1010 pin description (sorted by pin number)

Symbol	PIN Number	I/O	Description
ROM_SCL	1	O	SCL in I ² C for EEPROM interface
ROM_SDA	2	I/O	SDA in I ² C for EEPROM interface
GND	3		Ground
CPU_SCL	4	I	SCL in I ² C for CPU interface
CPU_SDA	5	I/O	SDA in I ² C for CPU interface
PWM_CTL	6	O	PWM control signal (Detail description in PWM Operation Section)
CLK_1M	7	I	Free Running Clock (default: 1MHz)
VDD	8		Power Supply
CLK_1M_O	9	O	Feedback of free Running Clock
RESET_B	10	I	System Reset (active LOW)
R_OSD	11	I	OSD Color Red
G_OSD	12	I	OSD Color Green
B_OSD	13	I	OSD Color Blue
EN_OSD	14	I	OSD Mixer Enable =0, No OSD output =1,R_OUT[7:0]= {R_OSD repeat 8 times} G_OUT[7:0]= {G_OSD repeat 8 times} B_OUT[7:0]= {B_OSD repeat 8 times}
SCAN_EN	15	I	Manufacturing test pin (NC)
TEST_EN	16	I	Manufacturing test pin (NC)
FCLK0	17	O	Input PLL Feedback Clock
VCLK0	18	I	Input Clock 0
FCLK1	19	O	Output PLL Feedback Clock
VCLK1	20	I	Output PLL Output Clock
HSYNC_O	21	O	Output HSYNC (the polarity is programmable through CPU, default is active low)
VSYNC_O	22	O	Output VSYNC (the polarity is programmable through CPU, default is active low)
DCLK_OUT	23	O	Output Clock to Control Panel (the polarity is programmable through CPU)
DE_OUT	24	O	Output Display Enable for Panel (the polarity is programmable through CPU, default is active HIGH)
GND	25		Ground
VDD	26		Power Supply
R_OUT0_E	27	O	Output Color Red Even Pixel (left pixel)
R_OUT1_E	28	O	Output Color Red Even Pixel (left pixel)
R_OUT2_E	29	O	Output Color Red Even Pixel (left pixel)
R_OUT3_E	30	O	Output Color Red Even Pixel (left pixel)
HSYNC_X	31	O	Default HSYNC generated by ASIC (active LOW)
R_OUT4_E	32	O	Output Color Red Even Pixel (left pixel)
R_OUT5_E	33	O	Output Color Red Even Pixel (left pixel)
R_OUT6_E	34	O	Output Color Red Even Pixel (left pixel)
R_OUT7_E	35	O	Output Color Red Even Pixel (left pixel)
GND	36		Ground
R_OUT0_O	37	O	Output Color Red Odd Pixel (right pixel)
R_OUT1_O	38	O	Output Color Red Odd Pixel (right pixel)
R_OUT2_O	39	O	Output Color Red Odd Pixel (right pixel)
R_OUT3_O	40	O	Output Color Red Odd Pixel (right pixel)

VDD	41		Power Supply
R_OUT4_O	42	O	Output Color Red Odd Pixel (right pixel)
R_OUT5_O	43	O	Output Color Red Odd Pixel (right pixel)
R_OUT6_O	44	O	Output Color Red Odd Pixel (right pixel)
R_OUT7_O	45	O	Output Color Red Odd Pixel (right pixel)
GND	46		Ground
G_OUT0_E	47	O	Output Color Green Even Pixel (left pixel)
G_OUT1_E	48	O	Output Color Green Even Pixel (left pixel)
G_OUT2_E	49	O	Output Color Green Even Pixel (left pixel)
G_OUT3_E	50	O	Output Color Green Even Pixel (left pixel)
G_OUT4_E	51	O	Output Color Green Even Pixel (left pixel)
VDD	52		Power Supply
G_OUT5_E	53	O	Output Color Green Even Pixel (left pixel)
G_OUT6_E	54	O	Output Color Green Even Pixel (left pixel)
G_OUT7_E	55	O	Output Color Green Even Pixel (left pixel)
GND	56		Ground
GND	57		Ground
G_OUT0_O	58	O	Output Color Green Odd Pixel (right pixel)
G_OUT1_O	59	O	Output Color Green Odd Pixel (right pixel)
G_OUT2_O	60	O	Output Color Green Odd Pixel (right pixel)
G_OUT3_O	61	O	Output Color Green Odd Pixel (right pixel)
VDD	62		Power Supply
G_OUT4_O	63	O	Output Color Green Odd Pixel (right pixel)
G_OUT5_O	64	O	Output Color Green Odd Pixel (right pixel)
G_OUT6_O	65	O	Output Color Green Odd Pixel (right pixel)
G_OUT7_O	66	O	Output Color Green Odd Pixel (right pixel)
GND	67		Ground
GND	68		Ground
B_OUT0_E	69	O	Output Color Blue Even Pixel (left pixel)
B_OUT1_E	70	O	Output Color Blue Even Pixel (left pixel)
B_OUT2_E	71	O	Output Color Blue Even Pixel (left pixel)
B_OUT3_E	72	O	Output Color Blue Even Pixel (left pixel)
B_OUT4_E	73	O	Output Color Blue Even Pixel (left pixel)
B_OUT5_E	74	O	Output Color Blue Even Pixel (left pixel)
B_OUT6_E	75	O	Output Color Blue Even Pixel (left pixel)
VDD	76		Power Supply
VDD	77		Power Supply
B_OUT7_E	78	O	Output Color Blue Even Pixel (left pixel)
GND	79		Ground
B_OUT0_O	80	O	Output Color Blue Odd Pixel (right pixel)
B_OUT1_O	81	O	Output Color Blue Odd Pixel (right pixel)
B_OUT2_O	82	O	Output Color Blue Odd Pixel (right pixel)
B_OUT3_O	83	O	Output Color Blue Odd Pixel (right pixel)
VDD	84		Power Supply
B_OUT4_O	85	O	Output Color Blue Odd Pixel (right pixel)
B_OUT5_O	86	O	Output Color Blue Odd Pixel (right pixel)
B_OUT6_O	87	O	Output Color Blue Odd Pixel (right pixel)
B_OUT7_O	88	O	Output Color Blue Odd Pixel (right pixel)
GND	89		Ground
R_IN00	90	I	Channel A Data Input Color Red (LSB)
R_IN01	91	I	Channel A Data Input Color Red
R_IN02	92	I	Channel A Data Input Color Red

R_IN03	93	I	Channel A Data Input Color Red
VDD	94		Power Supply
R_IN04	95	I	Channel A Data Input Color Red
R_IN05	96	I	Channel A Data Input Color Red
R_IN06	97	I	Channel A Data Input Color Red
R_IN07	98	I	Channel A Data Input Color Red (MSB)
GND	99		Ground
VDD	100		Power Supply
GND	101		Ground
G_IN00	102	I	Channel A Data Input Color Green (LSB)
G_IN01	103	I	Channel A Data Input Color Green
G_IN02	104	I	Channel A Data Input Color Green
G_IN03	105	I	Channel A Data Input Color Green
VDD	106		Power Supply
G_IN04	107	I	Channel A Data Input Color Green
G_IN05	108	I	Channel A Data Input Color Green
ADC_CLK0	109	O	Sample Clock for ADC 0
G_IN06	110	I	Channel A Data Input Color Green
G_IN07	111	I	Channel A Data Input Color Green (MSB)
GND	112		Ground
VDD	113		Power Supply
GND	114		Ground
B_IN00	115	I	Channel A Data Input Color Blue (LSB)
B_IN01	116	I	Channel A Data Input Color Blue
B_IN02	117	I	Channel A Data Input Color Blue
VDD	118		Power Supply
B_IN03	119	I	Channel A Data Input Color Blue
B_IN04	120	I	Channel A Data Input Color Blue
B_IN05	121	I	Channel A Data Input Color Blue
B_IN06	122	I	Channel A Data Input Color Blue
B_IN07	123	I	Channel A Data Input Color Blue (MSB)
GND	124		Ground
HSYNC_I	125	I	Input HSYNC (any polarity)
VSYNC_I	126	I	Input VSYNC (any polarity)
DE_IN	127	I	DE input for digital interface (reserved)
VDD	128		Power Supply

Table 2: SD1010 pin description (sorted by function)

Symbol	PIN Number	I/O	Description
R_IN00	90	I	Channel A Data Input Color Red (LSB)
R_IN01	91	I	Channel A Data Input Color Red
R_IN02	92	I	Channel A Data Input Color Red
R_IN03	93	I	Channel A Data Input Color Red
R_IN04	95	I	Channel A Data Input Color Red
R_IN05	96	I	Channel A Data Input Color Red
R_IN06	97	I	Channel A Data Input Color Red
R_IN07	98	I	Channel A Data Input Color Red (MSB)
G_IN00	102	I	Channel A Data Input Color Green (LSB)
G_IN01	103	I	Channel A Data Input Color Green
G_IN02	104	I	Channel A Data Input Color Green
G_IN03	105	I	Channel A Data Input Color Green
G_IN04	107	I	Channel A Data Input Color Green
G_IN05	108	I	Channel A Data Input Color Green
G_IN06	110	I	Channel A Data Input Color Green
G_IN07	111	I	Channel A Data Input Color Green (MSB)
B_IN00	115	I	Channel A Data Input Color Blue (LSB)
B_IN01	116	I	Channel A Data Input Color Blue
B_IN02	117	I	Channel A Data Input Color Blue
B_IN03	119	I	Channel A Data Input Color Blue
B_IN04	120	I	Channel A Data Input Color Blue
B_IN05	121	I	Channel A Data Input Color Blue
B_IN06	122	I	Channel A Data Input Color Blue
B_IN07	123	I	Channel A Data Input Color Blue (MSB)
HSYNC_I	125	I	Input HSYNC (any polarity)
VSYNC_I	126	I	Input VSYNC (any polarity)
DE_IN	127	I	DE input for digital interface (reserved)
ADC_CLK0	109	O	Sample Clock for ADC 0
R_OUT0_E	27	O	Output Color Red Even Pixel (left pixel)
R_OUT1_E	28	O	Output Color Red Even Pixel (left pixel)
R_OUT2_E	29	O	Output Color Red Even Pixel (left pixel)
R_OUT3_E	30	O	Output Color Red Even Pixel (left pixel)
R_OUT4_E	32	O	Output Color Red Even Pixel (left pixel)
R_OUT5_E	33	O	Output Color Red Even Pixel (left pixel)
R_OUT6_E	34	O	Output Color Red Even Pixel (left pixel)
R_OUT7_E	35	O	Output Color Red Even Pixel (left pixel)
R_OUT0_O	37	O	Output Color Red Odd Pixel (right pixel)
R_OUT1_O	38	O	Output Color Red Odd Pixel (right pixel)
R_OUT2_O	39	O	Output Color Red Odd Pixel (right pixel)
R_OUT3_O	40	O	Output Color Red Odd Pixel (right pixel)
R_OUT4_O	42	O	Output Color Red Odd Pixel (right pixel)
R_OUT5_O	43	O	Output Color Red Odd Pixel (right pixel)
R_OUT6_O	44	O	Output Color Red Odd Pixel (right pixel)
R_OUT7_O	45	O	Output Color Red Odd Pixel (right pixel)
G_OUT0_E	47	O	Output Color Green Even Pixel (left pixel)

G_OUT1_E	48	O	Output Color Green Even Pixel (left pixel)
G_OUT2_E	49	O	Output Color Green Even Pixel (left pixel)
G_OUT3_E	50	O	Output Color Green Even Pixel (left pixel)
G_OUT4_E	51	O	Output Color Green Even Pixel (left pixel)
G_OUT5_E	53	O	Output Color Green Even Pixel (left pixel)
G_OUT6_E	54	O	Output Color Green Even Pixel (left pixel)
G_OUT7_E	55	O	Output Color Green Even Pixel (left pixel)
G_OUT0_O	58	O	Output Color Green Odd Pixel (right pixel)
G_OUT1_O	59	O	Output Color Green Odd Pixel (right pixel)
G_OUT2_O	60	O	Output Color Green Odd Pixel (right pixel)
G_OUT3_O	61	O	Output Color Green Odd Pixel (right pixel)
G_OUT4_O	63	O	Output Color Green Odd Pixel (right pixel)
G_OUT5_O	64	O	Output Color Green Odd Pixel (right pixel)
G_OUT6_O	65	O	Output Color Green Odd Pixel (right pixel)
G_OUT7_O	66	O	Output Color Green Odd Pixel (right pixel)
B_OUT0_E	69	O	Output Color Blue Even Pixel (left pixel)
B_OUT1_E	70	O	Output Color Blue Even Pixel (left pixel)
B_OUT2_E	71	O	Output Color Blue Even Pixel (left pixel)
B_OUT3_E	72	O	Output Color Blue Even Pixel (left pixel)
B_OUT4_E	73	O	Output Color Blue Even Pixel (left pixel)
B_OUT5_E	74	O	Output Color Blue Even Pixel (left pixel)
B_OUT6_E	75	O	Output Color Blue Even Pixel (left pixel)
B_OUT7_E	78	O	Output Color Blue Even Pixel (left pixel)
B_OUT0_O	80	O	Output Color Blue Odd Pixel (right pixel)
B_OUT1_O	81	O	Output Color Blue Odd Pixel (right pixel)
B_OUT2_O	82	O	Output Color Blue Odd Pixel (right pixel)
B_OUT3_O	83	O	Output Color Blue Odd Pixel (right pixel)
B_OUT4_O	85	O	Output Color Blue Odd Pixel (right pixel)
B_OUT5_O	86	O	Output Color Blue Odd Pixel (right pixel)
B_OUT6_O	87	O	Output Color Blue Odd Pixel (right pixel)
B_OUT7_O	88	O	Output Color Blue Odd Pixel (right pixel)
HSYNC_O	21	O	Output HSYNC (the polarity is programmable through CPU, default is active low)
VSYNC_O	22	O	Output VSYNC (the polarity is programmable through CPU, default is active low)
DCLK_OUT	23	O	Output Clock to Control Panel (the polarity is programmable through CPU)
DE_OUT	24	O	Output Display Enable for Panel (the polarity is programmable through CPU, default is active HIGH)
FCLK0	17	O	Input PLL Feedback Clock
VCLK0	18	I	Input Clock 0
FCLK1	19	O	Output PLL Feedback Clock
VCLK1	20	I	Output PLL Output Clock
ROM_SCL	1	O	SCL in I ² C for EEPROM interface
ROM_SDA	2	I/O	SDA in I ² C for EEPROM interface
CPU_SCL	4	I	SCL in I ² C for CPU interface

CPU_SDA	5	I/O	SDA in I ² C for CPU interface
PWM_CTL	6	O	PWM control signal (Detail description in PWM Operation Section)
CLK_1M	7	I	Free Running Clock (default: 1MHz)
CLK_1M_O	9	O	Feedback of free Running Clock
RESET_B	10	I	System Reset (active LOW)
HSYNC_X	31	O	Default HSYNC generated by ASIC (active LOW)
R_OSD	11	I	OSD Color Red
G_OSD	12	I	OSD Color Green
B_OSD	13	I	OSD Color Blue
EN_OSD	14	I	OSD Mixer Enable =0, No OSD output =1, R_OUT[7:0]= {R_OSD repeat 8 times} G_OUT[7:0]= {G_OSD repeat 8 times} B_OUT[7:0]= {B_OSD repeat 8 times}
SCAN_EN	15	I	Manufacturing test pin (NC)
TEST_EN	16	I	Manufacturing test pin (NC)
VDD	8		Power Supply
VDD	26		Power Supply
VDD	41		Power Supply
VDD	52		Power Supply
VDD	62		Power Supply
VDD	76		Power Supply
VDD	77		Power Supply
VDD	84		Power Supply
VDD	94		Power Supply
VDD	100		Power Supply
VDD	106		Power Supply
VDD	113		Power Supply
VDD	118		Power Supply
VDD	128		Power Supply
GND	3		Ground
GND	25		Ground
GND	36		Ground
GND	46		Ground
GND	56		Ground
GND	57		Ground
GND	67		Ground
GND	68		Ground
GND	79		Ground
GND	89		Ground
GND	99		Ground
GND	101		Ground
GND	112		Ground
GND	114		Ground
GND	124		Ground

3. FUNCTIONAL DESCRIPTION

The SD1010A has the following major function blocks:

1. Input mode detection and auto calibration block
2. Buffer memory and read/write control block
3. Image scaling, interpolation and dithering block
4. OSD mixer and LCD interface block
5. EEPROM interface block
6. CPU interface block

The following sections will describe the functionality of these blocks.

3.1. Input mode detection & auto calibration block

3.1.1. Supported input modes

SD1010A can handle up to 14 different input modes. For SD1010A, an input mode is defined by its horizontal resolution with its vertical resolution. The input modes with the same horizontal and vertical resolution but with different frame rates are still considered as one single input mode. In the default EEPROM setup, SD1010A accepts the following seven input video modes:

1. 640 x 350
2. 640 x 400
3. 720 x 400
4. 640 x 480 (VGA)
5. 800 x 600 (SVGA)
6. 832 x 624 (MAC)
7. 1024 x 768 (XGA)

Users can easily change the definitions of the acceptable input modes by adjusting the values in the appropriate EEPROM entries. There is no frame rate restriction on the input modes. However, since the output signal is synchronized with the input signal at the same refresh rate, the input refresh rate has to be within the acceptable range of the LCD panel.

The user-defined video modes can be defined by storing appropriate timing information in the EEPROM. Detail definitions of the EEPROM entries are described in Section 3.5.2.

3.1.2. Input mode detection and frequency detection

The SD1010A can automatically detect the mode of the input signal without any user adjustment or driver running on the PC host or external CPU. This block automatically detects polarity of input synchronization and the sizes of back porch, valid data window and the synchronization pulse width in both vertical and horizontal directions. The size information is then used not only to decide the input resolution, to generate the frequency divider for the input PLL, to lock the PLL output clock with HSYNC, but also to automatically scale the image to full screen and to synchronize the output signal with the input signal.

The detection logic is always active to automatically detect any changes to the input mode. Users can manually change the input mode information at run time through the CPU interface. Detailed operation of the CPU interface is described in Section 3.6. "CPU Interface".

Mode detection and frequency detection can be independently turned ON or OFF by the external CPU. This feature allows system customers to have better control of the mode-detection and frequency detection process. When the detection is turned OFF, the external CPU can change the input mode and frequency definitions.

3.1.3. Phase calibration

The SD1010A can automatically calibrate the phase of the sample clock in order to preserve the bandwidth of the input signal and to get the best quality. The SD1010A implements a proprietary image quality function. During the auto-calibration process, the SD1010A continues to search for the best phase to optimize the image quality.

The output image may display some jitter and blurring during the auto-calibration process, and the image will become crisp and sharp once the optimum phase is found. User can change the sampling clock phase value through the external CPU. Detailed operation of the CPU interface is described in Section 3.6. "CPU Interface".

The phase calibration process can be delayed and even disabled by the external CPU if the system designer wants to have his/her own implementation. The phase calibration can be independently turned ON or OFF by the external CPU. When the calibration is turned OFF, the external CPU can change the input mode and frequency definitions.

3.1.4. PWM operation

The SD1010A implements a unique algorithm to adjust the phase of the A/D converter's sampling clock. An external delay circuit is required to compliment the SD1010A for the phase-calibration process. The SD1010A generates a Pulse-Width Modulated (PWM) signal to the external delay circuit. The delay circuit should insert a certain amount of time delay synchronization pulse based upon the width of the PWM signal. A brief circuit diagram for the PWM is shown in Figure 3.

The PWM signal from the SD1010A is a periodical signal with a period that is 1023 times the period of the free-running clock connected to the pin “CLK_1M”. System manufacturers may select any frequency for the free running clock. The default clock frequency is 1MHz. System manufacturers also decide the unit delay for the external delay circuit. The delay information is stored in the EEPROM. When the SD1010A wants to delay the synchronization pulse for N units of delay, it will output the PWM with the high time equal to $(N * \text{the period of the free-running clock})$, and with low time equal to $(1023-N) * \text{the period of the free-running clock}$. When $N=1023$, the PWM signal stays high all the time, and when $N=0$, the PWM signal is always low.

Figure 3: SD1010 PWM circuitry block diagram

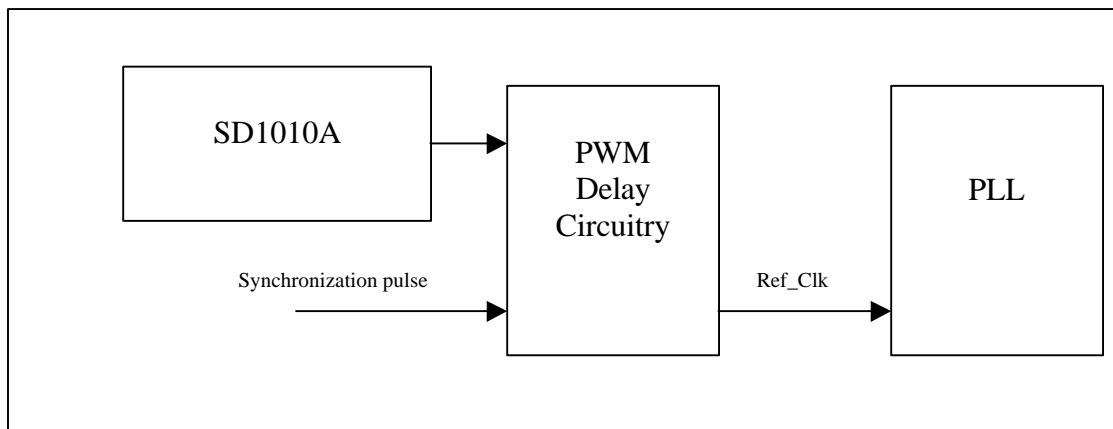

3.1.5. Free Running Clock

As described in previous section, a free-running clock is needed for the SD1010A. This clock is used for many of the SD1010A’s internal operations. PWM operation is one of them. System manufacturers can select the frequency of the free-running clock, and the default clock frequency is 1MHz. System manufacturers can use an oscillator to generate the free-running clock, and feed that clock directly to the pin “CLK_1M”, or use a crystal connecting to “CLK_1M” and “CLK_1M_O”.

3.2. Buffer memory and read/write control block

The SD1010A uses internal buffer memory to store a portion of the input image for image scaling and output synchronization. No external memory buffer is needed for the SD1010A. The write control logic ensures the input data are stored into the right area of the buffer memory, and the read control logic is responsible to fetch the data from the buffer memory from the correct area and at the correct timing sequence. With the precise timing control of the write and read logic, the output image is appropriately scaled to the full screen, and the output signal is perfectly synchronized with the input signals.

3.3. Image scaling, interpolation and dithering block

The SD1010A supports both automatic image scaling and interpolation.

3.3.1. Image scaling

The SD1010A supports several different input modes, and the input image may have different sizes. It is essential to support automatic image scaling so that the input image is always displayed to the full screen regardless the input mode. The SD1010A scales the images in both horizontal and vertical directions. It calculates the correct scaling ratio for both directions based upon the LCD panel resolution and the input mode and timing information produced by the “Input mode detection & auto calibration” block. The scaling ratio is re-adjusted whenever a different input mode is detected. The ratio is then fed to the buffer memory read control logic to fetch the image data with the right sequence and timing. Some of the image data may be read more than once to achieve the scaling effect.

3.3.2. Image interpolation

The SD1010A supports image interpolation to achieve better image quality. A basic image scaling algorithm replicates the input images to achieve the scaling effect. The replication scheme usually results in a poor image quality. The SD1010A implements a proprietary interpolation algorithm to improve the image quality. The programmable interpolation is implemented with a 256-entry mapping table in the EEPROM to allow system users to adjust the bi-linear interpolation parameters to control the sharpness and smoothness quality of the image. In the default setting, the mapping table contains a straight line of slope equal to 1, i.e. the data in entry N equal to the value N. If the mapping table contains a line of slope equal to 2, then the output image will be a bit sharper than the image generated by a table with the default setting. Through an external microcontroller, users can chose among different interpolation algorithm.

3.3.3. Dithering

The SD1010A supports 16.7 million true colors for a 6-bit panel. Two dithering algorithms are implemented and users can chose between them through the external microcontroller. The first one is area-based dithering, and the second one is a frame-based frame modulation, which also is called frame rate control. Through the external microcontroller, users can choose among different dithering algorithms.

3.3.4. Text Enhancement

In order to generate a good picture, the SD1010A incorporate a proprietary scheme to detect text and non-text picture. Then applying the appropriate process to improve the text image based on the detection of incoming source. By using the text enhancement

function correctly, the text image will look more pleasant and near perfect after scaled up or down. Users can achieve a preferred image by changing the settings in “text control” register.

3.3.5. Sharpness Enhancement

No matter how many times the original image got enlarged or shrunk by the internal interpolator. With the embedded powerful DSP arrays, SD1010A always can enhance the overall image sharpness (edge) to different degree for the various requirements. The sharpness can be adjusted bi-directionally which means either going sharper or softer to certain point set by the user. It’s easy to activate the sharpness enhancement by program “sharpness control” register.

3.4. OSD mixer and LCD interface

At the output stage, the SD1010A performs the OSD mixer function, and then generates the 24-bit / 48-bit RGB signal to the LCD panel with the correct timing.

3.4.1. OSD mixer

In the OSD mixer block, the SD1010A mixes the normal output RGB signal with the OSD signal. The OSD output data is generated based on the “R_OSD”, “G_OSD” and “B_OSD” pins as well as the “OSD Intensity” data in EEPROM entry. When the “EN_OSD” is active high, the OSD is active, and the SD1010A will send the OSD data to the LCD panel. The OSD has 16 different color schemes based on the combinations of the three OSD color pins and the “OSD Intensity” data. When R_OSD=1, and OSD_Intensity=0, the SD1010A will output 128 to the output red channel, R_OUT. When R_OSD=1 and OSD_Intensity=1, the SD1010A will output 255. The same scheme is used for G_OSD to G_OUT and for B_OSD to B_OUT.

As part of the mixer control function, the SD1010A implements three mixing control registers, “OSD R Weight” (38H), “OSD G Weight”(39H), and “OSD B Weight” (3AH). The mixing equation is shown below:

$$\begin{aligned} R_OUT &= (R_OSD) * (OSD\ R\ Weight/255) + R * (1 - OSD\ R\ Weight/255) \\ G_OUT &= (G_OSD) * (OSD\ G\ Weight/255) + G * (1 - OSD\ G\ Weight/255) \\ B_OUT &= (B_OSD) * (OSD\ B\ Weight/255) + B * (1 - OSD\ B\ Weight/255) \end{aligned}$$

When the weight is 255, the OSD output will overlay on top of the normal output. When the weight is 0, the OSD output is disabled.

3.4.2. LCD interface

The SD1010A support both 24- and 48-bit RGB interfaces with XGA LCD panels from various panel manufacturers. The LCD panel resolution and timing information is stored in the external EEPROM. The information in the EEPROM includes timing related to the output back porch, synchronization pulse width and valid data window. The timing information is used to generate the frequency divider for the output PLL, to lock the PLL output clock with HSYNC for the LCD data clock, and to synchronize the output VSYNC and input VSYNC.

3.5. EEPROM interface

As mentioned in previous sections, the external EEPROM stores crucial information for the SD1010A internal operations. The SD1010A interfaces with the EEPROM through a 2-wire serial interface. The suggested EEPROM device is an industry standard serial-interface EEPROM (24x08). The 2-wire serial interface scheme is briefly described here and a detailed description can be found in public literature.

3.5.1. 2-wire serial interface

The 2-wire serial interface uses 2 wires, SCL and SDA. The SCL is driven by the SD1010A and used mainly as the sampling clock. The SDA is a bi-directional signal and used mainly as a data signal. Figure 4 shows the basic bit definitions of the 2-wire serial interface.

The 2-wire serial interface supports random and sequential read operations. Figures 5 and 6 show the data sequences for random read and sequential read operations.

Figure 4: START, STOP AND DATA Definitions in 2-wire serial interface

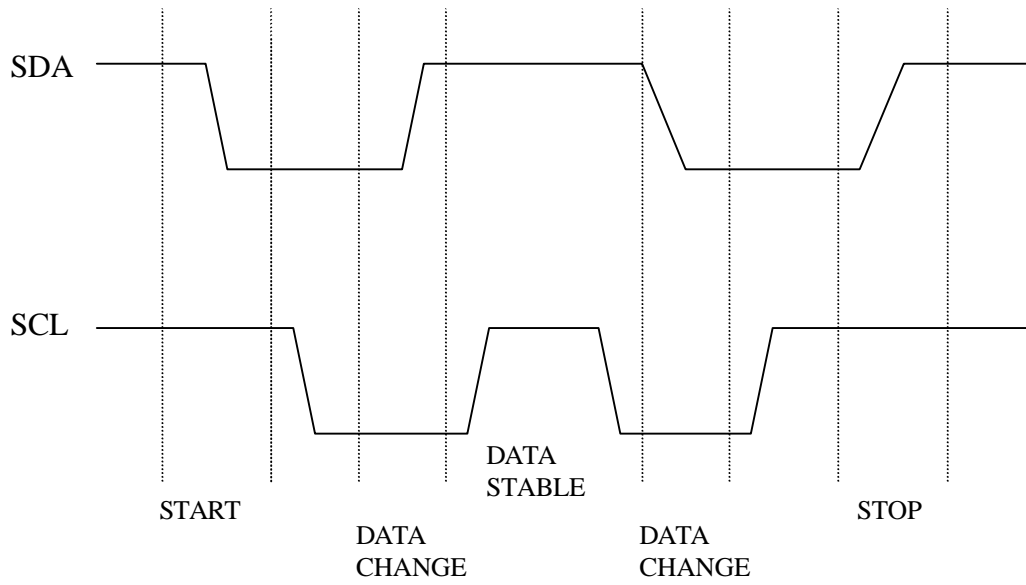

Figure 5: Data sequence for read access (both single and multiple bytes)

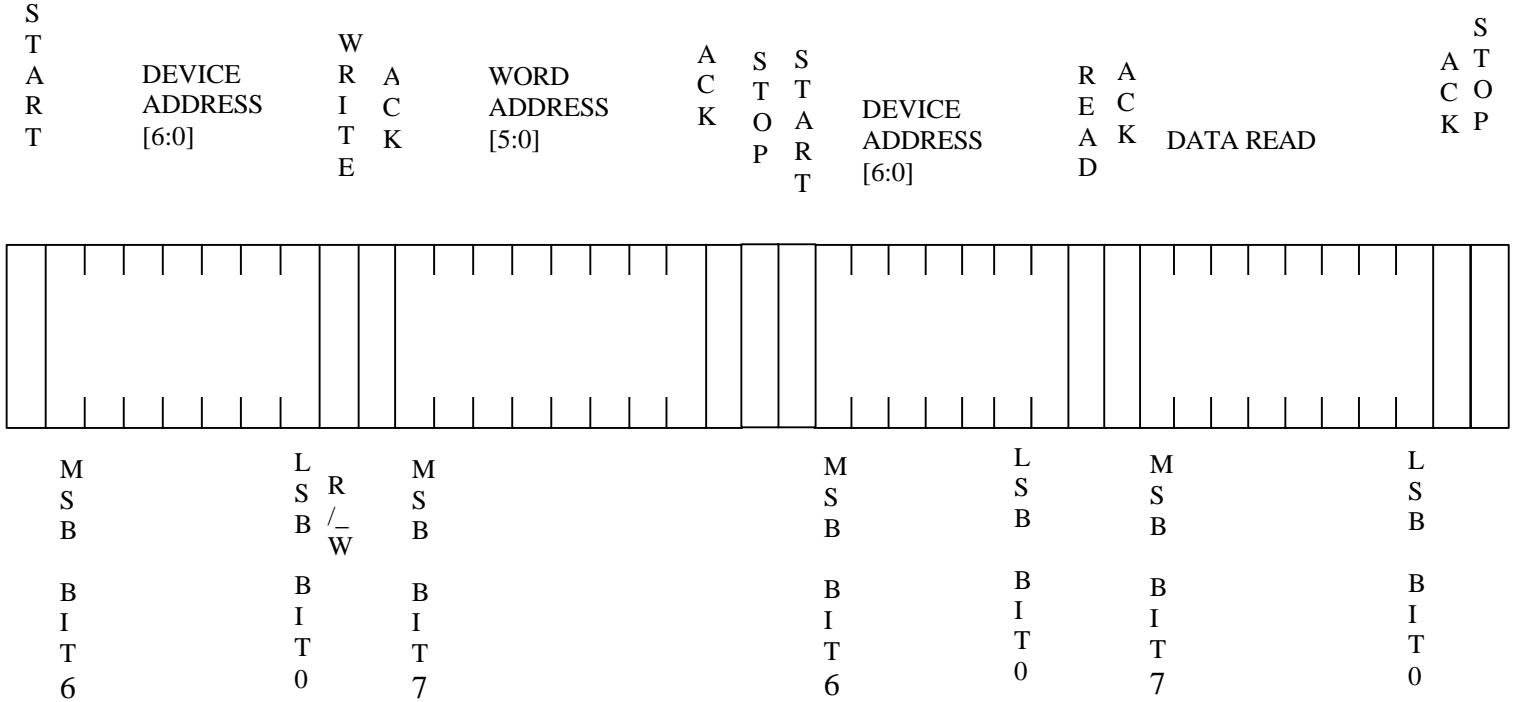
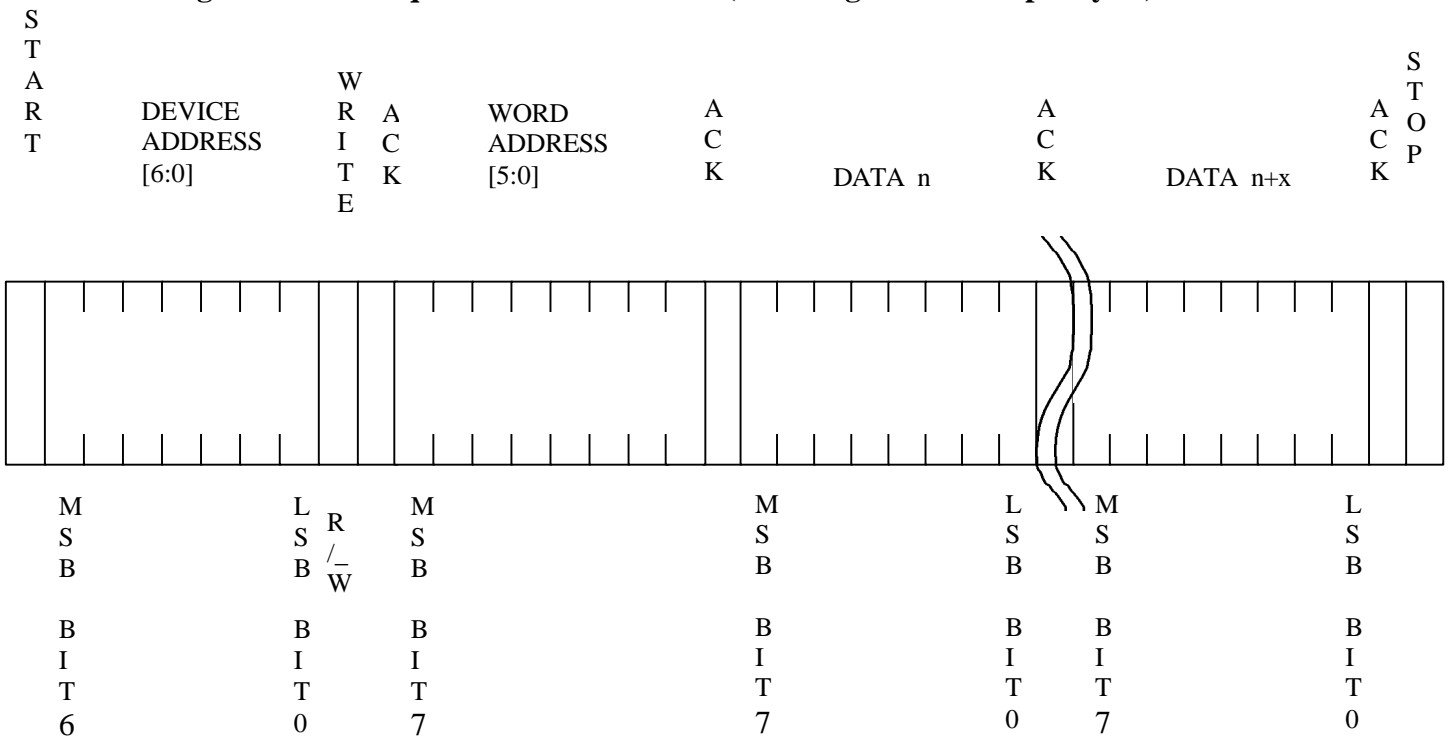

Figure 6: Data sequence for write access (both single and multiple bytes)



3.5.2. EEPROM Contents

The contents of EEPROM are primarily dependent on the specifications of the LCD panel. SmartASIC provides suggested EEPROM contents for LCD panels from various panel manufacturers. The section presents all the entries in the EEPROM, and briefly describes their definitions. This allows the system manufacturers to have their own EEPROM contents to distinguish their monitors.

The EEPROM contents can be partitioned into 15 parts. The first 14 parts are input mode dependent. When the SD1010A detects the input mode, it will then load the information related to the detected mode from the EEPROM. The information in the 15th part is mainly for input mode detection as well as some threshold values for error status indicators.

In the default setting, the SD1010A is set to recognize the following seven modes: 640x350, 640x400, 720x400, 640x480, 800x600, 832x624, and 1024x768 modes. Then the EEPROM will be partitioned as follows:

- Part 1: mode 1: 640x350 mode (in default setting)
- Part 2: mode 2: 640x400 mode (in default setting)
- Part 3: mode 3: 720x400 mode (in default setting)
- Part 4: mode 4: 640x480 mode (in default setting)
- Part 5: mode 5: 800x600 mode (in default setting)
- Part 6: mode 6: 832x624 mode (in default setting)
- Part 7: mode 7: 1024x768 mode (in default setting)
- Part 8: mode 8
- Part 9: mode 9
- Part 10: mode 10
- Part 11: mode 11
- Part 12: mode 12
- Part 13: mode 13
- Part 14: mode 14
- Part 15: input mode detection and scaling related parameters

Part 1-14: Input Mode Dependent Data

Symbol	Width (bits)	Address For 640x350	Description
VPW	11	00H 01H	LCD VSYNC pulse width
VBP	11	02H 03H	LCD VSYNC back porch (including VPW)
VBP Source	11	04H 05H	LCD VSYNC back porch (source equivalent) = VBP * Line Expansion and round up
Target Skip Pixel	11	06H 07H	If VBP can not be converted into source evenly, the leftover is converted into number of pixels
VSIZE	11	08H 09H	LCD number of lines
HPW	11	0AH 0BH	LCD HSYNC pulse width
HBP	11	0CH 0DH	LCD HSYNC back porch (including HPW)
HSIZE	11	0EH 0FH	LCD number of columns
HTOTAL	11	10H 11H	LCD total number of pixels per line including all porches
HTOTAL Source	12	12H 13H	LCD total number of clocks per line (source equivalent) = HTOTAL/Line Expansion
Line Expansion	4	14H [6:3]	Vertical source-to-destination scaling factor 0: one-to-one expansion (no expansion) 1-15: expansion ratio other than one-to-one (expansion)
Pixel Expansion	3	14H [2:0]	Horizontal source-to-destination scaling factor 0: one-to-one expansion (no expansion) 1-7: expansion ratio other than one-to-one (expansion)
H. Fog Factor	8	15H[7:0]	Horizontal fogging factor high byte
H. Fog Factor	8	16H[7:0]	Horizontal fogging factor low byte
V. Fog Factor	8	17H[7:0]	Vertical fogging factor high byte
V. Fog Factor	8	18H[7:0]	Vertical fogging factor low byte
Minimum Input lines [10:8]	3	19H[6:4]	Upper 3 bits of minimum input lines
Maximum Input pixels [10:8]	3	19H[2:0]	Upper 3 bits of maximum input pixels
Minimum input lines [7:0]	8	1AH	Minimum input lines = (VSIZE + VBP)* Line Expansion When the input has fewer lines than this value, it is considered as an ERROR, and INPUT_X status bit will be HIGH.
Maximum input pixels [7:0]	8	1BH	Maximum input pixels per line. Auto clock recovery will not set input PLL divisor larger than this value.
Source HSIZE[10:8]	3	1CH [6:4]	Source horizontal size upper 3 bits
Source	3	1CH [2:0]	Source vertical size upper 3 bits

VSIZE[10:8]			
Source HSIZE[7:0]	8	1DH	Source horizontal size lower 8 bits
Source VSIZE[7:0]	8	1EH	Source vertical size lower 8 bits
Check sum	8	1FH	Sum of above 31 bytes (keep lower 8 bits only)

Mode	Address Range
640x400	20H 3FH
720x400	40H 5FH
640x480	60H 7FH
800x600	80H 9FH
832x624	A0H BFH
1024x768	C0H DFH
User define Mode 1	E0H FFH
User define Mode 2	100H 11FH
User define Mode 3	120H 13FH
User define Mode 4	140H 15FH
User define Mode 5	160H 17FH
User define Mode 6	180H 19FH
User define Mode 7	1A0H 1BFH

Part 15: Input Mode Detection Data

Symbol	Width (bits)	Address	Description
Control byte 0	8	200H	Bit 6 – bit 0 : device ID for external CPU access Bit 7: fixed at 1 (reserved)
Control byte 1	8	201H	Bit0: 0: disable automatic input gain control 1: enable automatic input gain control Bit1: 0: enable input H/V SYNC polarity control (make input SYNC positive polarity) 1: bypass input H/V SYNC polarity control Bit2: fixed at 0 (reserved)

			Bit3: fixed at 0 (reserved) Bit4: 0: YUV input format is unsigned (128 offset) 1: YUV input format is signed Bit5: 0: RGB input for video mode 1: YUV input for video mode Bit6: 0: disable video input 1: enable video input Bit7: 0: disable decimation support 1: enable decimation
Control byte 2	8	202H	Bit 0: 0: don't invert input odd/even field indicator 1: invert input odd/even field indicator Bit 1: fixed at 0 (reserved) Bit 2: 0: disable BY2 for auto calibration 1: enable BY 2 for auto calibration Bit 3: 0: disable BY4 for auto calibration 1: enable BY 4 for auto calibration Bit 4: 0: disable BY8 for auto calibration 1: enable BY 8 for auto calibration Bit7-5: output clock phase adjustment, larger number gives larger phase delay.
Mode 640x350 Sync Polarity	2	203H[5:4]	The polarity of input synchronization signals. Bit 0 is for VSYNC and bit 1 is for HSYNC
Res0 threshold [10:8]	3	203H[2:0]	Upper bound of the line number for 640x350 mode
Res0 threshold [7:0]	8	204H	Upper bound of the line number for 640x350 mode, and lower bound for 640x400
Mode 640x400 Sync Polarity	2	205H[5:4]	The polarity of input synchronization signals. Bit 0 is for VSYNC and bit 1 is for HSYNC
Res1 threshold [10:8]	3	205H[2:0]	Upper bound of the line number for 640x400 mode
Res1 threshold [7:0]	8	206H	Upper bound of the line number for 640x400 mode, and lower bound for 720x400
Mode 720x400 Sync Polarity	2	207H[5:4]	The polarity of input synchronization signals. Bit 0 is for VSYNC and bit 1 is for HSYNC
Res2 threshold [10:8]	3	207H[2:0]	Upper bound of the line number for 720x400 mode
Res2 threshold [7:0]	8	208H	Upper bound of the line number for 720x400 mode, and lower bound for 640x480
Mode 640x480 Sync Polarity	2	209H[5:4]	The polarity of input synchronization signals. Bit 0 is for VSYNC and bit 1 is for HSYNC
Res3 threshold [10:8]	3	209H[2:0]	Upper bound of the line number for 640x480 mode
Res3 threshold [7:0]	8	20AH	Upper bound of the line number for 640x480 mode, and lower bound for 800x600
Mode 800x600 Sync Polarity	2	20BH[5:4]	The polarity of input synchronization signals. Bit 0 is for VSYNC and bit 1 is for HSYNC
Res4 threshold [10:8]	3	20BH[2:0]	Upper bound of the line number for 800x600 mode
Res4 threshold [7:0]	8	20CH	Upper bound of the line number for 800x600 mode, and lower bound for 832x624
Mode 832x624 Sync Polarity	2	20DH[5:4]	The polarity of input synchronization signals. Bit 0 is for VSYNC and bit 1 is for HSYNC
Res5 threshold	3	20DH[2:0]	Upper bound of the line number for 832x624 mode

[10:8]			
Res5 threshold [7:0]	8	20EH	Upper bound of the line number for 832x624 mode, and lower bound for 1024x768
Mode 1024x768 Sync Polarity	2	20FH[5:4]	The polarity of input synchronization signals. Bit 0 is for VSYNC and bit 1 is for HSYNC
Res6 threshold [10:8]	3	20FH[2:0]	Upper bound of the line number for 1024x768 mode
Res6 threshold [7:0]	8	210H	Upper bound of the line number for 1024x768 mode.
Reserve mode 1 Sync Polarity	2	211H[5:4]	The polarity of input synchronization signals. Bit 0 is for VSYNC and bit 1 is for HSYNC
Reserve mode 1 Res threshold [10:8]	3	211H[2:0]	Resolution threshold for reserve mode 1
Reserve mode 1 Res threshold [7:0]	8	212H	Resolution threshold for reserve mode 1.
Reserve mode 2 Sync Polarity	2	213H[5:4]	The polarity of input synchronization signals. Bit 0 is for VSYNC and bit 1 is for HSYNC
Reserve mode 2 Res threshold [10:8]	3	213H[2:0]	Resolution threshold for reserve mode 2
Reserve mode 2 Res threshold [7:0]	8	214H	Resolution threshold for reserve mode 2.
Reserve mode 3 Sync Polarity	2	215H[5:4]	The polarity of input synchronization signals. Bit 0 is for VSYNC and bit 1 is for HSYNC
Reserve mode 3 Res threshold [10:8]	3	215H[2:0]	Resolution threshold for reserve mode 3
Reserve mode 3 Res threshold [7:0]	8	216H	Resolution threshold for reserve mode3.
Reserve mode 4 Sync Polarity	2	217H[5:4]	The polarity of input synchronization signals. Bit 0 is for VSYNC and bit 1 is for HSYNC
Reserve mode4 Res threshold [10:8]	3	217H[2:0]	Resolution threshold for reserve mode 4
Reserve mode4 Res threshold [7:0]	8	218H	Resolution threshold for reserve mode 4
Reserve mode 5 Sync Polarity	2	219H[5:4]	The polarity of input synchronization signals. Bit 0 is for VSYNC and bit 1 is for HSYNC
Reserve mode 5 Res threshold [10:8]	3	219H[2:0]	Resolution threshold for reserve mode 5
Reserve mode 5 Res threshold [7:0]	8	21AH	Resolution threshold for reserve mode 5
Reserve mode 6 Sync Polarity	2	21BH[5:4]	The polarity of input synchronization signals. Bit 0 is for VSYNC and bit 1 is for HSYNC
Reserve mode 6 Res threshold [10:8]	3	21BH[2:0]	Resolution threshold for reserve mode 6
Reserve mode 6 Res threshold [7:0]	8	21CH	Resolution threshold for reserve mode 6
Reserve mode 7 Sync Polarity	2	21DH[5:4]	The polarity of input synchronization signals. Bit 0 is for VSYNC and bit 1 is for HSYNC
Reserve mode 7 Res threshold [10:8]	3	21DH[2:0]	Resolution threshold for reserve mode 7
Reserve mode 7 Res threshold [7:0]	8	21EH	Resolution threshold for reserve mode 7
Enable SYNC Check	14	21FH-220H	Enable SYNC polarity check during input mode detection. 1: enable SYNC polarity based mode detection

			0: disable SYNC polarity based mode detection bit 0: 640x350 bit 1: 640x400 bit 2: 720x400 bit 3: 640x480 bit 4: 800x600 bit 5: 832x624 bit 6: 1024x768 bit 7: res mode1 bit 8: res mode2 bit 9: res mode3 bit 10: res mode4 bit 11: res mode5 bit 12: res mode6 bit 13: res mode7
Maximum VBP	8	221H	The maximum vertical back porch for input video
Reserved Entries	8	222H-255H	Set to all 0 or all 1 (reserved)
Data low threshold	8	256H	Low water mark for valid data. If the data is smaller than this threshold, it is considered LOW internally
Data high threshold	8	257H	High water mark for valid data. If the data is larger than this threshold, it is considered HIGH internally
Edge threshold	8	258H	Minimum difference between the data value of two adjacent pixels to be considered as an edge
Calibration mode	2	259H [1:0]	Selects different operation modes of internal phase calibration. The selection criterion is as follows: 0: when input video signal has large overshoot, it results in longest calibration time 1: when input video signal has median overshoot, it results in long calibration time 2: when input video signal has normal overshoot, it results in normal calibration time (recommended) 3: when input video signal has no overshoot, it results in shortest calibration time
PWM unit delay	16	25AH-25BH	The unit delay used in the external PWM delay circuitry. If the free-running clock is 1MHz, and the intended unit delay is 0.2 ns (= 5,000MHz), then a value of $5,000\text{MHz}/1\text{MHz} = 5,000$ is used here.
Maximum link off time	22	25CH-25EH	Maximum time when input VSYNC is off before the LINK_DWN pin turns ON (unit: clock period of the free running clock). If the free-running clock is 1MHz, and the intended maximum time is 1 second, then a value of $1,000,000 \mu\text{s} / 1 \mu\text{s} = 1,000,000$ is used here.
Maximum refresh rate	16	25FH-260H	Maximum refresh rate supported by the LCD panel. If the intended maximum refresh rate is 75Hz, and the free-running clock is 1MHz, then a value of $1000000/75=133,333$ is used here
Maximum input frequency	8	261H	Maximum source clock rate supported by the SD1010 (unit: frequency of free-running clock). If the intended maximum clock rate is 60MHz, and the free-running clock is 1MHz, then a value of 60 is used here. If the input signal has a higher frequency than this value, the VCLK0_X status bit will turn ON.
Minimum pixels per line for LCD	11	262H-263H	Minimum number of pixels per line for LCD panel
LCD polarity	4	264H[3:0]	Controls the polarity of output VSYNC, HSYNC, clock and display enable:Bit0: 0: clock active high, 1: clock active low Bit1: 0: HSYNC active low, 1: HSYNC active high Bit2: 0: VSYNC active low, 1: VSYNC active high

			Bit4: 0: de active high, 1: de active low
Output enable for output pin 51-54, 56-59, 61-64, 66-69, 71-74, 76-79, 81-84, 86-89, 91-97, 99, 101-104, 106-109	1	265H[3]	Enable for programmable output pad: 1: output is enabled 0: output is tri-state
Driving capability control for output pin 51-54, 56-59, 61-64, 66-69, 71-74, 76-79, 81-84, 86-89, 91-97, 99, 101-104, 106-109	3	265H[2:0]	0: 2mA 1: 6mA 2: 6mA 3: 10mA 4: 4mA 5: 8mA 6: 8mA 7: 12mA
Output enable for output pin 49 (DE)	1	266H[7]	Enable for programmable output pad: 1: output is enabled 0: output is tri-state
Driving capability control for output pin 49 (DE)	3	266H[6:4]	0: 2mA 1: 6mA 2: 6mA 3: 10mA 4: 4mA 5: 8mA 6: 8mA 7: 12mA
Output enable for output pin 46 (HSYNC_O)	1	266H[3]	Enable for programmable output pad: 1: output is enabled 0: output is tri-state
Driving capability control for output pin 46 (HSYNC_O)	3	266H[2:0]	0: 2mA 1: 6mA 2: 6mA 3: 10mA 4: 4mA 5: 8mA 6: 8mA 7: 12mA
Output enable for output pin 49 (VSYNC_O)	1	267H[7]	Enable for programmable output pad: 1: output is enabled 0: output is tri-state
Driving capability control for output pin 49 (VSYNC_O)	3	267H[6:4]	0: 2mA 1: 6mA 2: 6mA 3: 10mA 4: 4mA 5: 8mA 6: 8mA 7: 12mA
Output enable for output pin 46 (DCLK_OUT)	1	267H[3]	Enable for programmable output pad: 1: output is enabled 0: output is tri-state
Driving capability control for output pin 46 (DCLK_OUT)	3	267H[2:0]	0: 2mA 1: 6mA 2: 6mA 3: 10mA 4: 4mA

			5: 8mA 6: 8mA 7: 12mA
Extension right	4	268H[7:4]	Numbers of pixels extended right for support of non-full screen expansion for secondary resolution to avoid exceeding panel specification
Extension left	4	268H[3:0]	Numbers of pixels extended left for support of non-full screen expansion for secondary resolution to avoid exceeding panel specification
Extension down	2	269H[1:0]	Numbers of lines extended down for support of non-full screen expansion for secondary resolution to avoid exceeding panel specification
Gamma_format0	24	26AH-26CH	26AH: gamma_format0_red 26BH: gamma_format0_green 26CH: gamma_format0_blue
Gamma_format1	24	26DH-26FH	26DH: gamma_format1_red 26EH: gamma_format1_green 26FH: gamma_format1_blue
Gamma_th0_r	8	270H	Gamma_threshold0 for red
Gamma_th1_r	8	271H	Gamma_threshold1 for red
Gamma_th2_r	8	272H	Gamma_threshold2 for red
Gamma_th3_r	8	273H	Gamma_threshold3 for red
Gamma_th4_r	8	274H	Gamma_threshold4 for red
Gamma_th5_r	8	275H	Gamma_threshold5 for red
Gamma_th6_r	8	276H	Gamma_threshold6 for red
Gamma_th0_g	8	277H	Gamma_threshold0 for green
Gamma_th1_g	8	278H	Gamma_threshold1 for green
Gamma_th2_g	8	279H	Gamma_threshold2 for green
Gamma_th3_g	8	27AH	Gamma_threshold3 for green
Gamma_th4_g	8	27BH	Gamma_threshold4 for green
Gamma_th5_g	8	27CH	Gamma_threshold5 for green
Gamma_th6_g	8	27DH	Gamma_threshold6 for green
Gamma_th0_b	8	27EH	Gamma_threshold0 for blue
Gamma_th1_b	8	27FH	Gamma_threshold1 for blue
Gamma_th2_b	8	280H	Gamma_threshold2 for blue
Gamma_th3_b	8	281H	Gamma_threshold3 for blue
Gamma_th4_b	8	282H	Gamma_threshold4 for blue
Gamma_th5_b	8	283H	Gamma_threshold5 for blue
Gamma_th6_b	8	284H	Gamma_threshold6 for blue
Gamma_scale0_r	8	285H	Gamma_scalefactor0 for red
Gamma_scale1_r	8	286H	Gamma_scalefactor1 for red
Gamma_scale2_r	8	287H	Gamma_scalefactor2 for red
Gamma_scale3_r	8	288H	Gamma_scalefactor3 for red
Gamma_scale4_r	8	289H	Gamma_scalefactor4 for red
Gamma_scale5_r	8	28AH	Gamma_scalefactor5 for red
Gamma_scale6_r	8	28BH	Gamma_scalefactor6 for red
Gamma_scale7_r	8	28CH	Gamma_scalefactor7 for red
Gamma_scale0_g	8	28DH	Gamma_scalefactor0 for green
Gamma_scale1_g	8	28EH	Gamma_scalefactor1 for green
Gamma_scale2_g	8	28FH	Gamma_scalefactor2 for green
Gamma_scale3_g	8	290H	Gamma_scalefactor3 for green
Gamma_scale4_g	8	291H	Gamma_scalefactor4 for green
Gamma_scale5_g	8	292H	Gamma_scalefactor5 for green

Gamma_scale6_g	8	293H	Gamma_scalefactor6 for green
Gamma_scale7_g	8	294H	Gamma_scalefactor7 for green
Gamma_scale0_b	8	295H	Gamma_scalefactor0 for blue
Gamma_scale1_b	8	296H	Gamma_scalefactor1 for blue
Gamma_scale2_b	8	297H	Gamma_scalefactor2 for blue
Gamma_scale3_b	8	298H	Gamma_scalefactor3 for blue
Gamma_scale4_b	8	299H	Gamma_scalefactor4 for blue
Gamma_scale5_b	8	29AH	Gamma_scalefactor5 for blue
Gamma_scale6_b	8	29BH	Gamma_scalefactor6 for blue
Gamma_scale7_b	8	29CH	Gamma_scalefactor7 for blue
Gamma_offset0_r	8	29DH	Gamma_offset0 for red
Gamma_offset1_r	8	29EH	Gamma_offset1 for red
Gamma_offset2_r	8	29FH	Gamma_offset2 for red
Gamma_offset3_r	8	2A0H	Gamma_offset3 for red
Gamma_offset4_r	8	2A1H	Gamma_offset4 for red
Gamma_offset5_r	8	2A2H	Gamma_offset5 for red
Gamma_offset6_r	8	2A3H	Gamma_offset6 for red
Gamma_offset7_r	8	2A4H	Gamma_offset7 for red
Gamma_offset0_g	8	2A5H	Gamma_offset0 for green
Gamma_offset1_g	8	2A6H	Gamma_offset1 for green
Gamma_offset2_g	8	2A7H	Gamma_offset2 for green
Gamma_offset3_g	8	2A8H	Gamma_offset3 for green
Gamma_offset4_g	8	2A9H	Gamma_offset4 for green
Gamma_offset5_g	8	2AAH	Gamma_offset5 for green
Gamma_offset6_g	8	2ABH	Gamma_offset6 for green
Gamma_offset7_g	8	2ACH	Gamma_offset7 for green
Gamma_offset0_b	8	2ADH	Gamma_offset0 for blue
Gamma_offset1_b	8	2AEH	Gamma_offset1 for blue
Gamma_offset2_b	8	2AFH	Gamma_offset2 for blue
Gamma_offset3_b	8	2B0H	Gamma_offset3 for blue
Gamma_offset4_b	8	2B1H	Gamma_offset4 for blue
Gamma_offset5_b	8	2B2H	Gamma_offset5 for blue
Gamma_offset6_b	8	2B3H	Gamma_offset6 for blue
Gamma_offset7_b	8	2B4H	Gamma_offset7 for blue
Check sum	8	2B5H	Sum of all part 9 bytes (keep only lower 8 bit)

3.6. CPU interface

The SD1010A supports a 2-wire serial interface to an external CPU. The interface allows the external CPU to access and modify control registers inside the SD1010A. The 2-wire serial interface is similar to the EEPROM interface, and the CPU is the host that drives the SCL all the time as the clock and for “start” and “stop” bits. The SCL frequency can be as high as 5MHz. The SDA is a bi-directional data wire. This interface supports random and sequential write operations for the CPU to modify one or multiple control registers, and random and sequential read operations for the CPU to read all or part of the control registers.

The default device ID for the SD1010A is fixed “1111111”. The device ID can be programmed through EEPROM entry 200H bit 0 through bit 6. This avoids any conflict with other 2-wire serial devices on the same bus.

The following table briefly describes the SD1010A control registers. The external CPU can read these registers to know the state of the SD1010A as well as the result of input mode detection and phase calibration. The external CPU can modify these control registers to disable several SD1010A features and force the SD1010A into a particular state. When the CPU modifies the control registers, the new data will be first stored in a set of shadow registers, and then copied into the actual control registers when the “CPU Control Enable” bit is set. When the “CPU Control Enable” bit is set, the external CPU will retain control and the SD1010A will not perform the auto mode detection and auto calibration.

The external CPU is able to adjust the size of the output image and move the output image up and down by simply changing the porch size and pixel and line numbers of the input signal. These adjustments can be tied to the external user control button on the monitor.

A set of four control registers are used to generate output signal when there is no input signal available to the SD1010A or the input signal is beyond the acceptable ranges. This operation mode is called standalone mode, which is very important for the end users when they accidentally select an input mode beyond the acceptable range of the SD1010A or when the input cable connection becomes loose for any reason. System manufacturers can display appropriate OSD warning messages on the LCD panel to notify the users about the problem.

Table 3: SD1010A Control Registers

Symbol	Width	Mode	Address	Description
VBP Source	11	RW	0H-1H	Input VSYNC back porch (not include pulse width)
VSIZE Source	11	RW	2H-3H	Input image lines per frame
VTOTAL Source	11	RW	4H-5H	Input total number of lines including porches
HBP Source	11	RW	6H-7H	Input HSYNC back porch (not include pulse width)
HSIZE Source	11	RW	8H-9H	Input image pixels per line
HTOTAL Source	11	RW	AH-BH	Input total number of pixels per line including porches
Mode Source	4	RW	CH[3:0]	Input video format 0: 640x350 1: 640x400 2: 720x400 3: 640x480 4: 800x600 5: 832x624 6: 1024x768 7: user defined mode 1 8: user defined mode 2 9: user defined mode 3 10: user defined mode 4

				11: user defined mode 5 12: user defined mode 6 13: user defined mode 7 14-15: error
Clock Phase Source	10	RW	DH-EH	Input sampling clock phase
VPW standalone	11	RW	FH-10H	For standalone mode, the pulse width of VSYNC
VTOTAL standalone	11	RW	11H-12H	For standalone mode, total number of line per frame
HPW standalone	11	RW	13H-14H	For standalone mode, HSYNC active time in μ s
HTOTAL standalone	11	RW	15H-16H	For standalone mode, HSYNC cycle time in μ s
Disable auto calibration for mode 640x350	1	RW	17H[7]	Disable auto calibration for this mode: 1: disable 0: enable
Delay auto calibration for mode 640x350	15	RW	17H[6:0]-18H	The number of frames need to be skipped before starting auto calibration for this mode
Disable auto calibration for mode 640x400	1	RW	19H[7]	Disable auto calibration for this mode: 1: disable 0: enable
Delay auto calibration for mode 640x400	15	RW	19H[6:0]-1AH	The number of frames need to be skipped before starting auto calibration for this mode
Disable auto calibration for mode 720x400	1	RW	1BH[7]	Disable auto calibration for this mode: 1: disable 0: enable
Delay auto calibration for mode 720x400	15	RW	1BH[6:0]-1CH	The number of frames need to be skipped before starting auto calibration for this mode
Disable auto calibration for mode 640x480	1	RW	1DH[7]	Disable auto calibration for this mode: 1: disable 0: enable
Delay auto calibration for mode 640x480	15	RW	1DH[6:0]-1EH	The number of frames need to be skipped before starting auto calibration for this mode
Disable auto calibration for mode 800x600	1	RW	1FH[7]	Disable auto calibration for this mode: 1: disable 0: enable
Delay auto calibration for mode 800x600	15	RW	1FH[6:0]-20H	The number of frames need to be skipped before starting auto calibration for this mode
Disable auto calibration for mode 832x624	1	RW	21H[7]	Disable auto calibration for this mode: 1: disable 0: enable
Delay auto calibration for mode 832x624	15	RW	21H[6:0]-22H	The number of frames need to be skipped before starting auto calibration for this mode
Disable auto calibration for mode 1024x768	1	RW	23H[7]	Disable auto calibration for this mode: 1: disable 0: enable
Delay auto calibration for mode 1024x768	15	RW	23H[6:0]-24H	The number of frames need to be skipped before starting auto calibration for this mode
Disable auto calibration for mode INVALID	1	RW	25H[7]	Disable auto calibration for this mode: 1: disable 0: enable

Delay auto calibration for mode INVALID	15	RW	25[6:0]-26H	The number of frames need to be skipped before starting auto calibration for this mode
Bypass Sync Polarity	1	RW	27H[7]	Bypass Input SYNC polarity detection (default 0): 1: bypass input SYNC polarity detection 0: detect input SYNC polarity and make them negative polarity
Dithering Enable	1	RW	28H[7]	Enable dithering for 6-bit panel (default 0): 1: enable dithering 0: disable dithering *also check register Control_C[6]
Frame Modulation Enable	1	RW	28H[6]	Enable frame modulation for 6-bit panel (default 0): 1: enable frame modulation 0: disable frame modulation *also check register Control_B[5] and Control_B[7]
Horizontal Interpolation Enable	1	RW	28H[5]	Enable horizontal interpolation (default 0): 1: enable horizontal interpolation 0: disable horizontal interpolation
Vertical Interpolation Enable	1	RW	28H[4]	Enable vertical interpolation (default 0): 1: enable vertical interpolation 0: disable vertical interpolation
Horizontal Rounding Enable	1	RW	28H[3]	Enable horizontal rounding (default 0): 1: enable horizontal rounding 0: disable horizontal rounding
Vertical Rounding Enable	1	RW	28H[2]	Enable vertical rounding (default 0): 1: enable vertical rounding 0: disable vertical rounding
Horizontal Table Lookup Enable	1	RW	28H[1]	Enable horizontal Table Lookup (default 0): 1: enable horizontal Table Lookup 0: disable horizontal Table Lookup
Vertical Table Lookup Enable	1	RW	28H[0]	Enable vertical Table Lookup (default 0): 1: enable vertical Table Lookup 0: disable vertical Table Lookup
HSYNC Threshold Enable	1	RW	29H[4]	Enable detection of short lines (IBM panel only, default 0): 1: Enable such detection 0: disable such detection
OSD Intensity	1	RW	29H[3]	OSD intensity selection: 0: half intensity 1: full intensity
Load ALL EEPROM	1	RW	29H[2]	Should be kept low most of the time. A high pulse will force SD1010 to reload all EEPROM entries
Load Mode Dependent EEPROM	1	RW	29H[1]	Should be kept low most of the time. A high pulse will force SD1010 to reload mode dependent EEPROM entries
CPU control enable	1	RW	29H[0]	External CPU control enable: 0: disable external CPU control. SD1010 can write control registers, but CPU only read control registers. 1: enable external CPU control. CPU can read/write control registers. SD1010 cannot write control registers
Status 0	8	R	2AH	Read only internal status registers: 1: indicate error status 0: indicate normal status

				Bit 0: EEPROM vertical lookup table loading Bit 1: EEPROM horizontal lookup table loading Bit 2: EEPROM mode dependent entries loading Bit 3: EEPROM calibration entries loading Bit 4: input has too few lines Bit 5: no input video Bit 6: input data clock is too fast Bit 7: refresh rate exceed LCD panel specification
Status 1	4	R	2BH[3:0]	Internal auto calibration state 0: Idle State 1-4: Loading EEPROM data 5-9: Frequency Calibration State (Auto Frequency Calibration will be done after state 9) 10: Phase Calibration State (Auto Phase Calibration will be done after state 10) 11: Adjust Horizontal Back Porch state 12: Phase Tracking state
Control_A	8	RW	2CH[7:0]	Control Register A: 0 – disable 1 – enable default is 00H Bit 0: Horizontal Interpolation Offset Enable Bit 1: Vertical Interpolation Offset Enable Bit 2: Horizontal Interpolation Fraction Reset Enable Bit 3: Vertical Interpolation Fraction Reset Enable Bit 4: Horizontal Interpolation Integer Increment Enable Bit 5: Vertical Interpolation Integer Increment Enable Bit 6: Single Pixel Output Mode Enable Bit 7: Disable “DE_OUT”, for blanking screen purpose
Control_B	8	RW	2DH[7:0]	Control Register B Bit [2:0]: Pixel Comparison Mode: 0: compare r even(default) 1: compare g even 2: compare b even 3: invalid 4: compare r odd 5: compare g odd 6: compare b odd 7: invalid *Using pixel comparison should program register “Pixel Comparison Value” and check register “Status 2[1:0]” Bit [4:3]: Brightness Control: 0: disable brightness control(default) 1: reduce brightness 2: increase brightness 3: invalid *Using brightness control should specify register “Brightness Adjustment” and check register “Status 2[2]”

				<p>Bit [5]: Frame Modulation Mode: 0: 2-bit mode(default) 1: 1-bit mode</p> <p>Bit [6]: 6-bit Panel Rounding Enable: 0: disable(default) 1: enable</p> <p>Bit [7]: Frame Modulation Scheme Selection: 0: Scheme A(default) 1: Scheme B</p>
Control_C	8	RW	2EH[7:0]	<p>Control Register C</p> <p>Bit [1:0]: Horizontal Interpolation Special Processing Mode: 0: disable 1: linear 2: replication(default) 3: invalid</p> <p>Bit [3:2]: Vertical Interpolation Special Processing Mode: 0: disable 1: linear 2: replication(default) 3: invalid</p> <p>Bit [4]: OSD Transparency Enable: 0: disable(default) 1: enable *also need to program registers “OSD R Weight”, “OSD G Weight” and “OSD B Weight”</p> <p>Bit [5]: Advanced Post Processing Enable: 0: disable(default) 1: enable *also need to specify registers “Advanced Processing R Weight”, “Advanced Processing G Weight”, “Advanced Processing B Weight”, “Advanced Processing R Value”, “Advanced Processing G Value” and “Advanced Processing B Value” for properly functioning</p> <p>Bit [6]: Dithering Scheme Selection 0: Scheme A(default) 1: Scheme B</p> <p>Bit [7]: Reserved</p>
Control_D	8	RW	2FH[7:0]	<p>Control Register D</p> <p>Bit [3:0]: Advanced Processing Shift Amount. From 0 – 8. 8 is the default value.</p> <p>Bit [4]: Advance Mixing Shift Enable 0: disable(default) 1: enable</p>

				*This is a option for Advanced Post Processing Bit [7:5]: Reserved
Interpolation H. Offset	8	RW	30H[7:0]	High Byte For Interpolation Horizontal Offset Default is 00H
Interpolation H. Offset	8	RW	31H[7:0]	Low Byte For Interpolation Horizontal Offset Default is 00H
Interpolation V. Offset	8	RW	32H[7:0]	High Byte For Interpolation Vertical Offset Default is 00H
Interpolation V. Offset	8	RW	33H[7:0]	Low Byte For Interpolation Vertical Offset Default is 00H
H. Interpolation Rest Count	8	RW	34H[7:0]	Bit [2:0]: High Bits For Horizontal Interpolation Reset Count. Default is 0H. Bit [7:3]: Reserved
H. Interpolation Reset Count	8	RW	35H[7:0]	Low Byte For Horizontal Interpolation Reset Count. Default is 00H.
V. Interpolation Reset Count	8	RW	36H[7:0]	Bit [1:0]: High Bits For Vertical Interpolation Reset Count. Default is 0H.
V. Interpolation Reset Count	8	RW	37H[7:0]	Low Byte For Interpolation Vertical Reset Count. Default is 00H.
OSD R Weight	8	RW	38H[7:0]	Mixing Weight For OSD R. Default is 00H.
OSD G Weight	8	RW	39H[7:0]	Mixing Weight For OSD G. Default is 00H.
OSD B Weight	8	RW	3AH[7:0]	Mixing Weight For OSD B. Default is 00H.
Advanced Processing R Weight	8	RW	3BH[7:0]	Weight For Advanced Post Processing R default is 00H
Advanced Processing G Weight	8	RW	3CH[7:0]	Weight For Advanced Post Processing G Default is 00H
Advanced Processing B Weight	8	RW	3DH[7:0]	Weight For Advanced Post Processing B Default is 00H
Advanced Processing R Value	8	RW	3EH[7:0]	Value For Advanced Post Processing R Default is 00H
Advanced Processing G Value	8	RW	3FH[7:0]	Value For Advanced Post Processing G Default is 00H
Advanced Processing B Value	8	RW	40H[7:0]	Value For Advanced Post Processing B Default is 00H
Brightness Adjustment	8	RW	41H[7:0]	The Adjust Amount For Reducing/Increasing Brightness. Default is 00H.
Pixel Comparison Value	8	RW	42H[7:0]	The Value To Compare The Incoming Pixel Data. Default is 00H.
Status 2	8	R	43H[7:0]	The Status Register 2 Bit [1:0]: Result for comparing the selected incoming pixel with "Pixel Comparison Value": 0: invalid 1: incoming pixel > "Pixel Comparison Value" 2: incoming pixel = "Pixel Comparison Value" 3: incoming pixel < "Pixel Comparison Value" Bit [2]: Status for brightness control 0: Normal, no underflow/overflow 1: brightness reduced too much causes underflow/increased too much causes overflow

				Bit [7:3]: Reserved
Recovery Control	8	RW	44H	Clock Recovery Control Register: Default value is 71H Bit 0: clock frequency is divisible by 2 Bit 1: clock frequency is divisible by 4 Bit 2: clock frequency is divisible by 8 Bit 3: enable phase tracking feature Bit 4: enable auto phase calibration Bit 5: enable auto frequency calibration Bit 6: enable auto mode detection Bit 7: fixed at 0 (reserved)
Phase Range	4	RW	45H	Offset value added to the calibrated phase when phase tracking occurs
Phase Track Waiting Time	24	RW	46H 48H	Number of frames waited before phase tracking occurs
Quick Phase Enable	1	RW	49H[0]	0: Normal phase calibration (default) 1: Final phase = phase total – phase offset
PWM Enable	1	RW	49H[1]	0: Disable auto phase total calculation 1: Enable auto phase total calculation (default)
Standalone Enable	1	RW	49H[2]	0: Uses the external incoming SYNC signals (default) 1: Allow the use of the default SYNC signals instead of the incoming SYNC signals
Reserved Entry	1	RW	49H[3]	Fixed at 0 (reserved)
Phase Offset	10	RW	4AH 4BH	Offset value subtracted from phase total when doing quick phase calculation
Phase Total	10	RW	4CH 4DH	User defined value for a particular frequency
Image Quality Index	30	R	4EH[5:0], 4FH, 50H, 51H	Read only register for CPU to monitor Image Quality Index. The Image Quality Index is used by auto phase calibration.
Text Control	8	RW	52H[7:0]	Text-Enhancement Control Bit[0]: text enhancement enable 0: disable 1: enable Bit[1]: Reserved Bit[6:2]: text-enhanced level Level 0 – 14. Level “0” is the same as original source, and “14” is the highest enhancement level. Bit[7]: Reserved Default is 00H
Sharpness Control	8	RW	53H[7:0]	Sharpness-Enhancement Control Bit[0]: sharpness enhancement enable 0: disable 1: enable Bit[1]: Reserved

				<p>Bit[6:2]: sharpness-enhanced level Level 1 – 19. Level “5” is the same as the original source. From “4” to “1” intend to soften the picture, and “1” is the softest level. From level “6” to “19” will sharpen the picture gradually. Level “19” is the sharpest output.</p> <p>Bit[7]: Reserved</p> <p>Default is 14H</p>
Control_E	8	RW	54H[7:0]	<p>Control Register E</p> <p>Bit[3:0]: text enhancement threshold.</p> <p>Bit[4]: reserved</p> <p>Bit[6:5]: Frame Modulation Mode 0: compatible with SD1010 1-3: new schemes</p> <p>Bit[7]: reserved</p> <p>Default is 05H</p>
Pixel_h	11	RW	55H[10:8] 56H[7:0]	The x location for reading “Pixel_out” register
Pixel_v	11	RW	57H[10:8] 58H[7:0]	The y location for reading “Pixel_out” register
Pixle_out	24	R	59H, 5AH, 5BH	Read out pixel located by “Pixel_h” and “Pixel_v”
Fc3_start	1	RW	5CH[4]	Forces auto calibration to recalculate h back porch
Channel_select	1	RW	5CH[3]	Only for single pixel input 0: takes input data from channel 1 1: takes input data from channel 0 For 128 pin package, set this bit at 0
Dual_pixel	1	RW	5CH[2]	0: takes input from one single channel 1: takes input from both channels. For 128 pin package, set this bit at 0
Soft_start	1	RW	5CH[1]	Restarts auto calibration without going into reset
ICS_phase_state	1	RW	5CH[0]	Forces auto calibration to calculate the image quality for a particular clock phase when supplied by ics chips
Hsize_by842_en	1	RW	5DH[7]	Turn on internal hsize matching by8, 4, 2 when clock frequency calibration is done by8, 4, 2. Used mainly for special non-full screen inputs.
Video_mode	1	RW	5DH[6]	0: disable input video mode 1: input is video
Input_yuv	1	RW	5DH[5]	0: input video format is RGB 1: input video format is YUV 4:2:2
Yuv_signed	1	RW	5DH[4]	0: input video YUV format is unsigned 1: input video YUV format is signed
decimation	1	RW	5DH[3]	Used when input resolution is higher than output 1: enable special decimation control 0: disable special decimation
Detect_en	2	RW	5DH[2:1]	Input data range detection. The results are put in register 64H and 65H

				0: disable detection 1: detect MAX/MIN using R color 2: detect MAX/MIN using G color 3: detect MAX/MIN using B color
Agc_en	1	RW	5DH[0]	Automatic gain control enable
Agc_gain_red	8	RW	5EH	Gain amount for R color
Agc_gain_green	8	RW	5FH	Gain amount for G color
Agc_gain_blue	8	RW	60H	Gain amount for B color
Agc_offset_red	8	RW	61H	Offset amount for R color
Agc_offset_green	8	RW	62H	Offset amount for G color
Agc_offset_blue	8	RW	63H	Offset amount for B color
Input_max	8	R	64H	Detected maximum input data (please see 5DH)
Input_min	8	R	65H	Detected minimum input data (please see 5DH)
ICS_freq_state	1	RW	66H[5]	Forces auto calibration to calculate the hsize value for a particular clock frequency when supplied by ics chips
ICS_hsize_valid	1	RW	66H[4]	Indicates when hsize value is ready for cpu to read in ics mode. Can be clear by cpu
ICS_iq_valid	1	RW	66H[3]	Indicates when image quality is ready for cpu to read in ics mode. Can be clear by cpu
IQ_valid	1	RW	66H[2]	Indicates when image quality is ready for cpu to read in Regular non-ics mode. Can be clear by cpu
Divisor_valid	1	RW	66H[1]	Indicates when auto clock frequency calibration is done and frequency value is ready for cpu to read. Can be clear by cpu
Non_full_Screen	1	RW	66H[0]	Indicates when input data is non full screen. Can be clear by cpu
Divisor_value	11	R	67H[2:0], 68H	Read only register containing value of clock frequency when divisor_valid is asserted
IQ_value	30	R	69H[5:0], 6AH,6BH, 6CH	Read only register containing value of image quality when either ics_iq_valid or iq_valid is asserted
Panel_on	1	RW	6DH[0]	1: turn on all the outputs to the panel 0: disable outputs to the panel (need to disable EEPROM 265H[3], 266H[7], 266H[3], 267H[7], 267H[3] to get complete output disable).
ICS_hsize_value	11	R	6EH[2:0], 6FH	Read only register containing value of hsize when ics_hsize_valid is asserted
Rom_clk_sel	6	RW	70H[5:0]	Divisor value use to divide fast pwm_free_clk to slower free_clk

3.7. Control Flow

When SD1010A is powered up, the reference system and SD1010A will perform the following functions in sequence:

1. System will generate a Power-On Reset to SD1010A.
2. Once the SD1010A receives the Reset, SD1010A will load the contents of EEPROM and start the auto-calibration process.

3. In the meantime, the external CPU can change the contents of the control registers of the SD1010A. If necessary, the external CPU can send an additional Reset to restart the whole process.

4. ELECTRICAL SPECIFICATIONS

This section presents the electrical specifications of the SD1010A.

4.1. Absolute Maximum Ratings

Symbol	Parameter	Rating	Units
VCC	Power Supply	-0.3 to 3.6	V
Vin	Input Voltage	-0.3 to VCC + 0.3	V
Vout	Output Voltage	-0.3 to VCC + 0.3	V
VCC5	Power Supply for 5V	-0.3 to 6.0	V
Vin5	Input Voltage for 5V	-0.3 to VCC5 + 0.3	V
Vout5	Output Voltage for 5V	-0.3 to VCC5 + 0.3	V
TSTG	Storage Temperature	-55 to 150	°C

4.2. Recommended Operating Conditions

Symbol	Parameter	Min.	Typ.	Max.	Units
VCC	Power Supply	3.0	3.3	3.6	V
Vin	Input Voltage	0		VCC	V
VCC5	Commercial Power Supply for 5V	4.75	5.0	5.25	V
VIN5	Input Voltage for 5V	0	-	VCC5	V
TJ	Commercial Junction Operating Temperature	0	25	115	°C

4.3. General DC Characteristics

Symbol	Parameter	Conditions	Min.	Typ.	Max.	Units
IIL	Input Leakage Current	no pull – up or pull - down	-1		1	μA
IOZ	TRI-state Leakage Current		-1		1	μA
CIN3	3.3V Input Capacitance			2.8		ρF
COU3	3.3V Output Capacitance		2.7		4.9	ρF
CBID3	3.3V Bi-directional Buffer Capacitance		2.7		4.9	ρF
CIN5	5V Input Capacitance			2.8		ρF
COU5	5V Output Capacitance		2.7		5.6	ρF
CBID5	5V Bi-directional Buffer Capacitance		2.7		5.6	ρF

Note: The capacitance above does not include PAD capacitance and package capacitance. One can estimate pin capacitance by adding pad capacitance, which is about 0.5 ρF, and the package capacitance

4.4. DC Electrical Characteristics for 3.3 V Operation

(Under Recommended Operation Conditions and $V_{CC} = 3.0 \sim 3.6V$, $T_J = 0^\circ C$ to $+115^\circ C$)

Symbol	Parameter	Conditions	Min.	Typ.	Max.	Units
VIL	Input low voltage	CMOS			0.3*VCC	V
VIH	Input high voltage	CMOS	0.7*VCC			V
VT-	Schmitt trigger negative going threshold voltage	COMS		1.20		V
VT+	Schmitt trigger positive going threshold voltage	COMS		2.10		V
VOL	Output low voltage	IOH=2,4,8,12,16,24 mA			0.4	V
VOH	Output high voltage	IOH=2,4,8,12,16,24 mA	2.4			V
RI	Input pull-up /down resistance	VIL=0V or VIH=VCC		75		K Ω

4.5. DC Electrical Characteristics for 5V Operation

(Under Recommended Operation Conditions and $V_{CC}=4.75\sim 5.25$, $T_J=0^\circ C$ to $+115^\circ C$)

Symbol	Parameter	Conditions	Min.	Typ.	Max.	Units
VIL	Input low voltage	COMS			0.3*VCC	V
VIH	Input high voltage	COMS	0.7*VCC			V
VIL	Input low voltage	TTL			0.8	V
VIH	Input high voltage	TTL	2.0			V
VT-	Schmitt trigger negative going threshold voltage	CMOS		1.78		V
VT+	Schmitt trigger positive going threshold voltage	COMS		3.00		V
VT-	Schmitt trigger negative going threshold voltage	TTL		1.10		V
VT+	Schmitt trigger positive going threshold voltage	TTL		1.90		V
VOL	Output low voltage	IOL=2,4,8,16,24mA			0.4	V
VOH	Output high voltage	IOH=2,4,8,16,24 mA	3.5			V
RI	Input pull-up / down resistance	VIL=0V or VIH=VCC		50		K Ω

5. PACKAGE DIMENSIONS

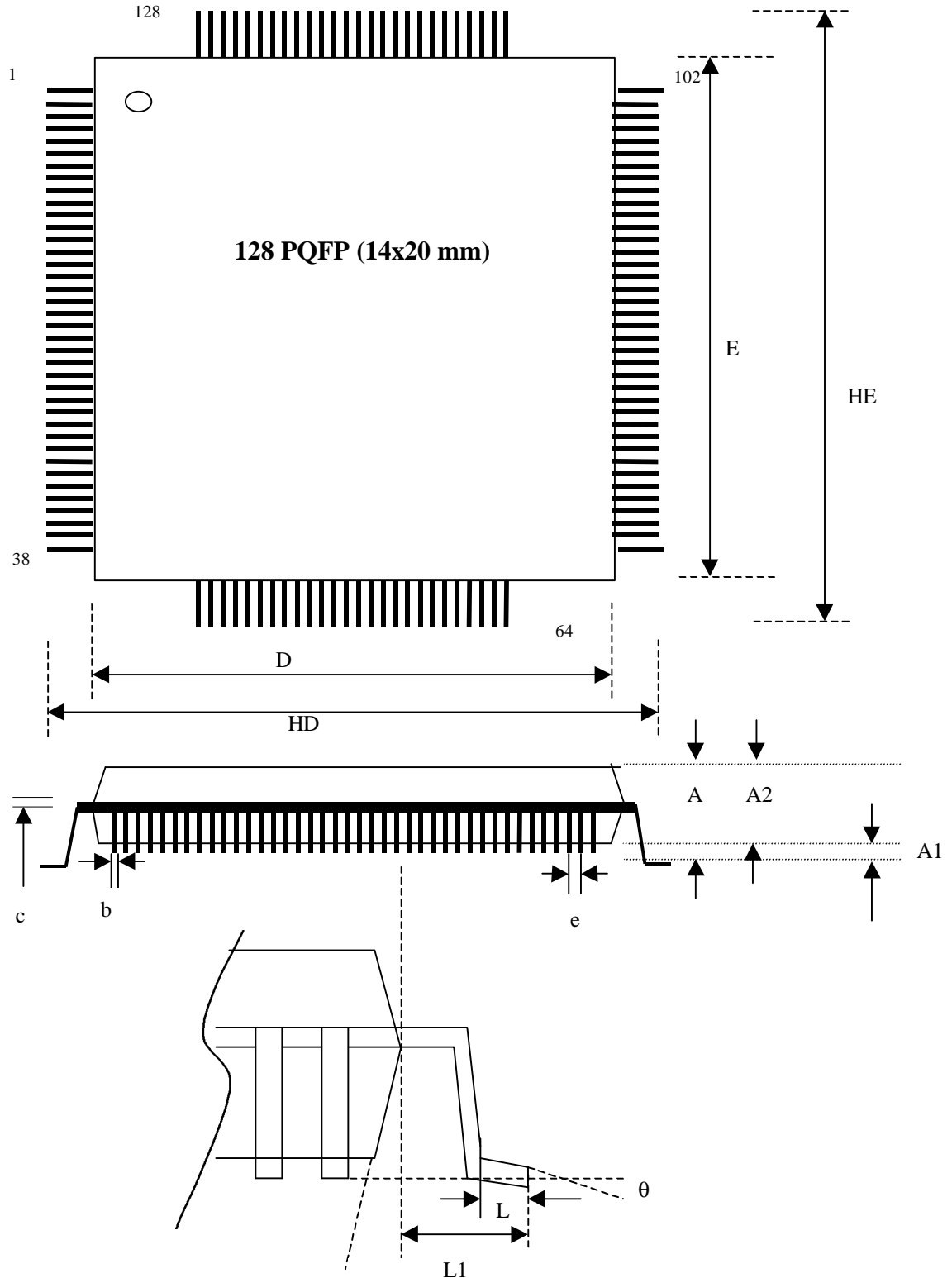

Symbol\Unit	Inch (Base)	MM (Base)
A	0.134(Max)	3.40 (Max)
A1	0.010 (Min)	0.25 (Min)
A2	0.112 +/-0.003	2.85 +/- 0.08
b	0.007 (Min) – 0.011(Max)	0.17(Min) – 0.27(Max)
c	.004 (Min) – 0.008 (Max)	0.09(Min) – 0.20(Max)
D	0.551+/-0.002	14.000+/-0.10
E	0.787+/-0.002	20.000+/-0.10
e	0.020 (Ref)	0.5 (Ref)
HD	0.677 +/- 0.01	17.20 +/- 0.25
HE	0.913 +/- 0.01	23.20 +/- 0.25
L	0.035+/-0.006	0.88+/-0.15
L1	0.063(Ref)	1.60(Ref)
θ	0 - 7.0°	0 - 7.0°

6. ORDER INFORMATION

Order Code	Temperature	Package	Speed
SD1010	Commercial 0°C ~ 70°C	128-pin PQFP 14 x 20 (mm)	100MHz

SmartASIC, Inc.

U.S.A. & Europe
525 Race St. Suite 250
San Jose, CA 95126 U.S.A.
Tel : 1-408-283-5098
Fax : 1-408-283-5099

WORLDWIDE OFFICES

Asia Pacific
3F, No. 68, Chou-Tze St. Nei-Hu Dist.
Taipei 114, Taiwan R.O.C.
Tel : 886-2-8797-7889
Fax : 886-2-8797-6829

@Copyright 1999, SmartASIC, Inc.

This information in this document is subject to change without notice. SmartASIC subjects its products to normal quality control sampling techniques which are intended to provide an assurance of high quality products suitable for usual commercial applications. SmartASIC does not do testing appropriate to provide 100% product quality assurance and does not assume any liability for consequential or incidental arising from any use of its products. If such products are to be used in applications in which personal injury might occur from failure, purchaser must do its own quality assurance testing appropriate to such applications.