

## FST3306 2-Bit Low Power Bus Switch

### General Description

The FST3306 is a 2-bit ultra high-speed CMOS FET bus switch with TTL-compatible active LOW control inputs. The low on resistance of the switch allows inputs to be connected to outputs with minimal propagation delay and without generating additional ground bounce noise. The device is organized as a 2-bit switch with independent bus enable (BE) controls. When BE is LOW, the switch is ON and Port A is connected to Port B. When BE is HIGH, the switch is OPEN and a high-impedance state exists between the two ports. Control inputs tolerate voltages up to 5.5V independent of  $V_{CC}$ .

### Features

- Typical  $3\Omega$  switch resistance at 5.0V  $V_{CC}$
- Minimal propagation delay through the switch
- Power down high impedance input/output
- Zero bounce in flow through mode.
- TTL compatible active LOW control inputs
- Control inputs are overvoltage tolerant

### Ordering Code:

Order Number	Package Number	Package Description
FST3306MTC	MTC08	8-Lead Thin Shrink Small Outline Package (TSSOP), JEDEC MO-153, 4.4mm Wide

Devices also available in Tape and Reel. Specify by appending the suffix letter "X" to the ordering code.

### Logic Symbol

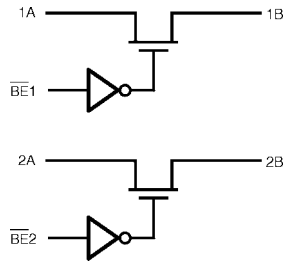

### Connection Diagram

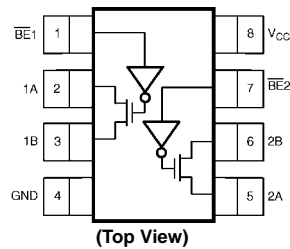

### Pin Descriptions

Pin Name	Description
A	Bus A
B	Bus B
$\overline{BE}$	Bus Enable Input

### Function Table

Bus Enable Input $\overline{BE}$	Function
L	B Connected to A
H	Disconnected

H = HIGH Logic Level  
L = LOW Logic Level

**Absolute Maximum Ratings** (Note 1)

Supply Voltage ( $V_{CC}$ )	-0.5V to +7.0V
DC Switch Voltage (VS)	-0.5V to +7.0V
DC Output Voltage ( $V_{IN}$ ) (Note 2)	-0.5V to +7.0V
DC Input Diode Current ( $I_{IK}$ ) $V_{IN} < 0V$	-50 mA
DC Output ( $I_{OUT}$ ) Current	128 mA
DC $V_{CC}$ or Ground Current ( $I_{CC}/GND$ )	$\pm 100$ mA
Storage Temperature Range ( $T_{STG}$ )	-65°C to +150°C
Junction Lead Temperature under Bias ( $T_J$ )	+150°C
Lead Temperature ( $T_L$ ) (Soldering, 10 seconds)	+260°C
Power Dissipation ( $P_D$ ) @ +85°C	250 mW

**Recommended Operating Conditions** (Note 3)

Supply Operating ( $V_{CC}$ )	4.0V to 5.5V
Control Input Voltage ( $V_{IN}$ )	0V to 5.5V
Switch Input Voltage ( $V_{IN}$ )	0V to 5.5V
Output Voltage ( $V_{OUT}$ )	0V to 5.5V
Operating Temperature ( $T_A$ )	-40°C to +85°C
Input Rise and Fall Time ( $t_r, t_f$ )	
Control Input	0 ns/V to 5 ns/V
Switch I/O	0 ns/V to DC
Thermal Resistance ( $\theta_{JA}$ )	250°C/W

**Note 1:** The "Absolute Maximum Ratings" are those values beyond which the safety of the device cannot be guaranteed. The device should not be operated at these limits. The parametric values defined in the Electrical Characteristics tables are not guaranteed at the absolute maximum ratings. The "Recommended Operating Conditions" table will define the conditions for actual device operation.

**Note 2:** The input and output negative voltage ratings may be exceeded if the input and output diode current ratings are observed.

**Note 3:** Unused logic inputs must be held HIGH or LOW. They may not float.

**DC Electrical Characteristics**

Symbol	Parameter	$V_{CC}$ (V)	$T_A = -40^\circ\text{C to } +85^\circ\text{C}$			Units	Conditions
			Min	Typ	Max		
$V_{IK}$	Clamp Diode Voltage	4.5			-1.2	V	$I_{IN} = -18$ mA
$V_{IH}$	HIGH Level Input Voltage	4.0-5.5	2.0			V	
$V_{IL}$	LOW Level Input Voltage	4.0-5.5			0.8	V	
$V_{OH}$	HIGH Level Output Voltage	4.5-5.5	see Figure 3			V	$V_{IN} = V_{CC}$
$I_{IN}$	Input Leakage Current	5.5			$\pm 1.0$	$\mu\text{A}$	$0 \leq V_{IN} \leq 5.5V$
$I_{OFF}$	Switch OFF Leakage Current	5.5			$\pm 1.0$	$\mu\text{A}$	$0 \leq A, B, \leq V_{CC}$
$R_{ON}$	Switch On Resistance (Note 4)	4.5	3	7		$\Omega$	$V_{IN} = 0V, I_{IN} = 64$ mA
		4.5	3	7	$V_{IN} = 0V, I_{IN} = 30$ mA		
		4.5	6	15	$V_{IN} = 2.4V, I_{IN} = 15$ mA		
		4.0	10	20	$V_{IN} = 2.4V, I_{IN} = 15$ mA		
$I_{CC}$	Quiescent Supply Current	5.5			3	$\mu\text{A}$	$V_{IN} = V_{CC}$ or GND, $I_{OUT} = 0$
$\Delta I_{CC}$	Increase in $I_{CC}$ per Input (Note 5)	5.5	1	2.5		mA	$V_{IN} = 3.4V, I_O = 0$ , Control Input Only

**Note 4:** Measured by the voltage drop between A and B pins at the indicated current through the switch. On resistance is determined by the lower of the voltages on the two (A or B) pins.

**Note 5:** Per TTL driven input ( $V_{IN} = 3.4V$ , control input only). A and B pins do not contribute to  $I_{CC}$ .

## AC Electrical Characteristics

Symbol	Parameter	V <sub>CC</sub> (V)	T <sub>A</sub> = -40°C to +85°C			Units	Conditions	Figure Number
			C <sub>L</sub> = 50 pF, R <sub>U</sub> = R <sub>D</sub> = 500Ω					
			Min	Typ	Max			
t <sub>PHL</sub> t <sub>PLH</sub>	Prop Delay Bus to Bus (Note 6)	4.0-5.5			0.25	ns	V <sub>I</sub> = OPEN	Figures 1, 2
t <sub>PZL</sub> t <sub>PZH</sub>	Output Enable Time	4.5-5.5	0.8	2.5	4.2	ns	V <sub>I</sub> = 7V for t <sub>PZL</sub> V <sub>I</sub> = 0V for t <sub>PZH</sub>	Figures 1, 2
		4.0	0.8	3.0	4.6			
t <sub>PLZ</sub> t <sub>PHZ</sub>	Output Disable Time	4.5-5.5	0.8	3.1	4.8	ns	V <sub>I</sub> = 7V for t <sub>PLZ</sub> V <sub>I</sub> = 0V for t <sub>PHZ</sub>	Figures 1, 2
		4.0	0.8	2.9	4.4			

**Note 6:** This parameter is guaranteed. The bus switch contributes no propagation delay other than the RC delay of the typical On resistance of the switch and the 50 pF load capacitance, when driven by an ideal voltage source (zero output impedance). The specified limit is calculated on this basis.

## Capacitance

Symbol	Parameter	Typ	Max	Units	Conditions
C <sub>IN</sub>	Control Pin Input Capacitance	2.5		pF	V <sub>CC</sub> = 0V
C <sub>I/O</sub> (OFF)	Port OFF Capacitance	6		pF	V <sub>CC</sub> = 5.0V = $\overline{\text{BE}}$
C <sub>I/O</sub> (ON)	Switch ON Capacitance	12		pF	V <sub>CC</sub> = 5.0V, $\overline{\text{BE}}$ = 0V

## AC Loading and Waveforms

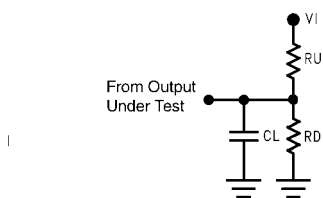

Input driven by 50Ω source terminated in 50Ω.  
C<sub>L</sub> includes load and stray capacitance.  
Input PRR = 1.0 MHz t<sub>w</sub> = 500 ns.

FIGURE 1. AC Test Circuit

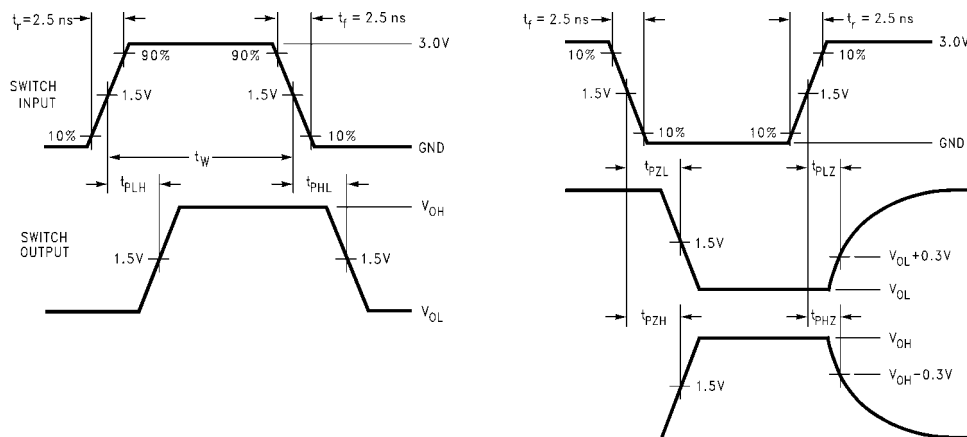

FIGURE 2. AC Waveforms

DC Characteristics

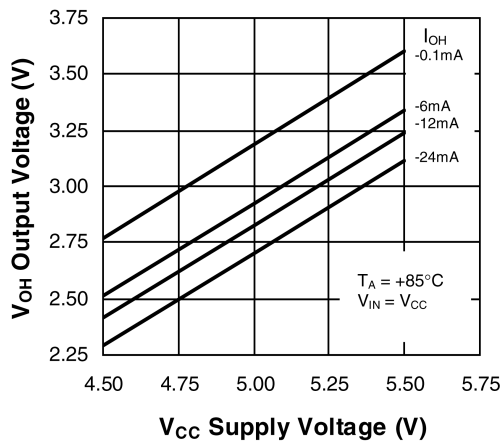
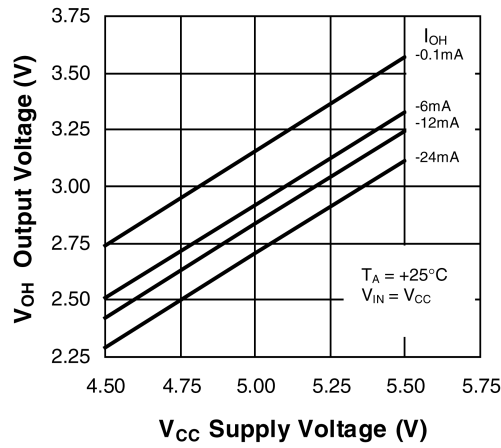
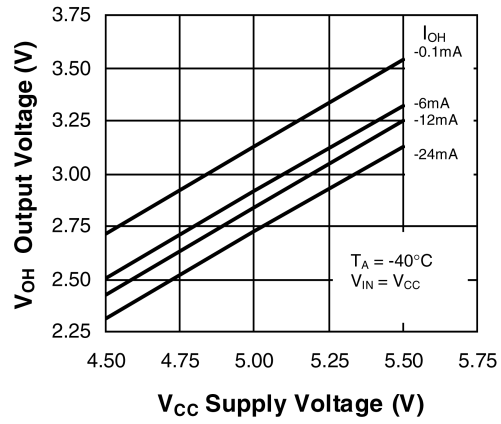
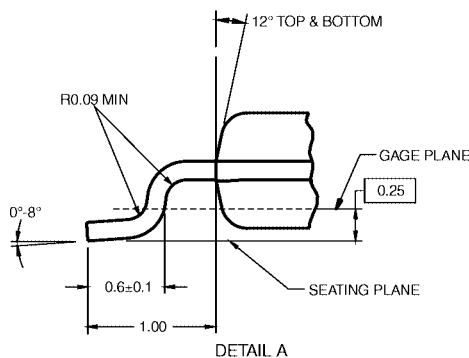
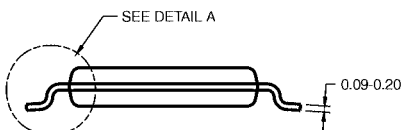
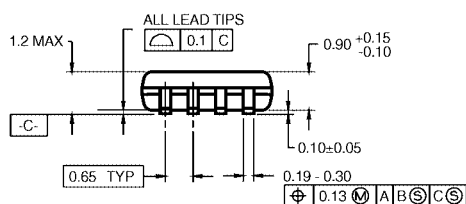
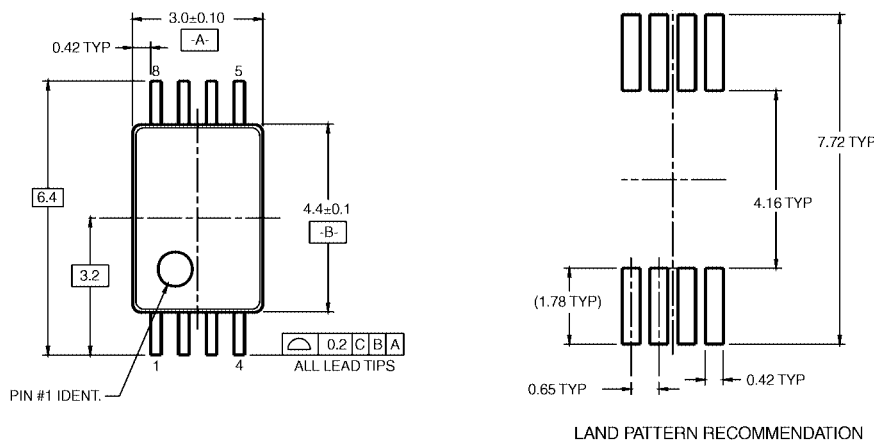

FIGURE 3. Typical High Level Output Voltage vs. Supply Voltage

**Physical Dimensions** inches (millimeters) unless otherwise noted



DIMENSIONS ARE IN MILLIMETERS

**NOTES:**

- A. CONFORMS TO JEDEC REGISTRATION MO-153, VARIATION AB, REF NOTE 6, DATE 7/93.
- B. DIMENSIONS ARE IN MILLIMETERS.
- C. DIMENSIONS ARE EXCLUSIVE OF BURRS, MOLD FLASH, AND TIE BAR EXTRUSIONS.
- D. DIMENSIONS AND TOLERANCES PER ANSI Y14.5M, 1982.

MTC08RevA1

**8-Lead Thin Shrink Small Outline Package (TSSOP), JEDEC MO-153, 4.4mm Wide Package Number MTC08**

Fairchild does not assume any responsibility for use of any circuitry described, no circuit patent licenses are implied and Fairchild reserves the right at any time without notice to change said circuitry and specifications.

**LIFE SUPPORT POLICY**

FAIRCHILD'S PRODUCTS ARE NOT AUTHORIZED FOR USE AS CRITICAL COMPONENTS IN LIFE SUPPORT DEVICES OR SYSTEMS WITHOUT THE EXPRESS WRITTEN APPROVAL OF THE PRESIDENT OF FAIRCHILD SEMICONDUCTOR CORPORATION. As used herein:

1. Life support devices or systems are devices or systems which, (a) are intended for surgical implant into the body, or (b) support or sustain life, and (c) whose failure to perform when properly used in accordance with instructions for use provided in the labeling, can be reasonably expected to result in a significant injury to the user.
2. A critical component in any component of a life support device or system whose failure to perform can be reasonably expected to cause the failure of the life support device or system, or to affect its safety or effectiveness.

[www.fairchildsemi.com](http://www.fairchildsemi.com)