

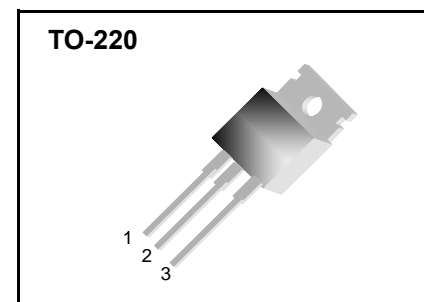
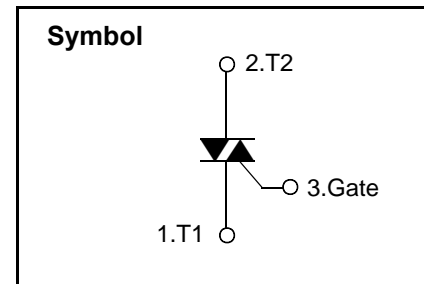
## Sensitive Gate Triacs

### Features

- ◆ Repetitive Peak Off-State Voltage : 600V
- ◆ R.M.S On-State Current (  $I_{T(RMS)}= 4 A$  )
- ◆ High Commutation  $dv/dt$
- ◆ Sensitive Gate Triggering 4 Mode
- ◆ Non-isolated Type

### General Description

This device is sensitive gate triac suitable for direct coupling to TTL, HTL, CMOS and application such as various logic functions, low power AC switching applications, such as fan speed, small light controllers and home appliance equipment.



### Absolute Maximum Ratings ( $T_J = 25^{\circ}C$ unless otherwise specified )

Symbol	Parameter	Condition	Ratings	Units
$V_{DRM}$	Repetitive Peak Off-State Voltage		600	V
$I_{T(RMS)}$	R.M.S On-State Current	$T_C = 107^{\circ}C$	4.0	A
$I_{TSM}$	Surge On-State Current	One Cycle, 50Hz/60Hz, Peak, Non-Repetitive	30/33	A
$I^2t$	$I^2t$		4.5	A <sup>2</sup> s
$P_{GM}$	Peak Gate Power Dissipation		1.5	W
$P_{G(AV)}$	Average Gate Power Dissipation		0.1	W
$I_{GM}$	Peak Gate Current		1.0	A
$V_{GM}$	Peak Gate Voltage		7.0	V
$T_J$	Operating Junction Temperature		- 40 ~ 125	$^{\circ}C$
$T_{STG}$	Storage Temperature		- 40 ~ 150	$^{\circ}C$

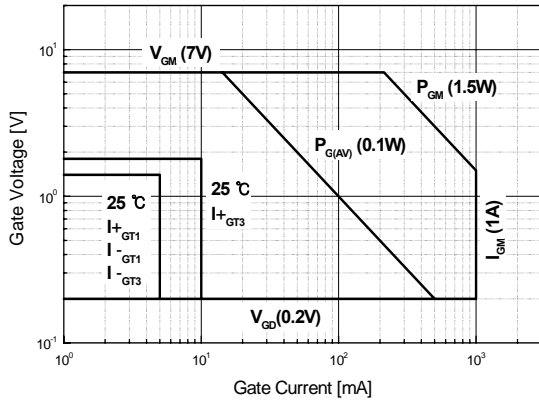
# STP4A60S

## Electrical Characteristics

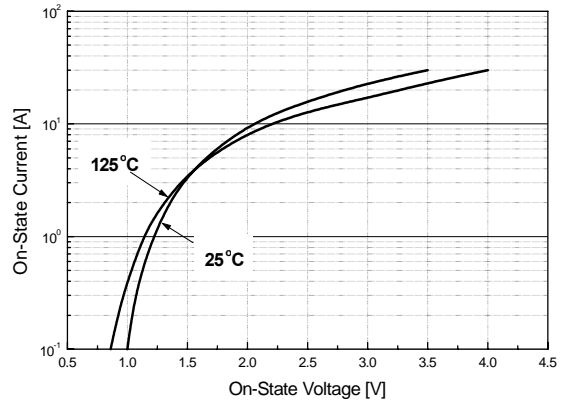
Symbol	Items		Conditions	Ratings			Unit
				Min.	Typ.	Max.	
$I_{DRM}$	Repetitive Peak Off-State Current		$V_D = V_{DRM}$ , Single Phase, Half Wave $T_J = 125\text{ }^\circ\text{C}$	—	—	1.0	mA
$V_{TM}$	Peak On-State Voltage		$I_T = 6\text{ A}$ , Inst. Measurement	—	—	1.6	V
$I_{GT1}^+$	I	Gate Trigger Current	$V_D = 6\text{ V}$ , $R_L = 10\text{ }\Omega$	—	—	5	mA
$I_{GT1}^-$	II			—	—	5	
$I_{GT3}^-$	III			—	—	5	
$I_{GT3}^+$	IV			—	8	12	
$V_{GT1}^+$	I	Gate Trigger Voltage	$V_D = 6\text{ V}$ , $R_L = 10\text{ }\Omega$	—	—	1.4	V
$V_{GT1}$	II			—	—	1.4	
$V_{GT3}$	III			—	—	1.4	
$V_{GT3}^+$	IV			—	1.6	2.0	
$V_{GD}$	Non-Trigger Gate Voltage		$T_J = 125\text{ }^\circ\text{C}$ , $V_D = 1/2 V_{DRM}$	0.2	—	—	V
$(dv/dt)_c$	Critical Rate of Rise Off-State Voltage at Commutation		$T_J = 125\text{ }^\circ\text{C}$ , $[di/dt]_c = -0.5\text{ A/ms}$ , $V_D = 2/3 V_{DRM}$	5	—	—	V/ $\mu\text{s}$
$I_H$	Holding Current			—	—	10	mA
$R_{th(j-c)}$	Thermal Impedance		Junction to case	—	—	3.0	$^\circ\text{C/W}$



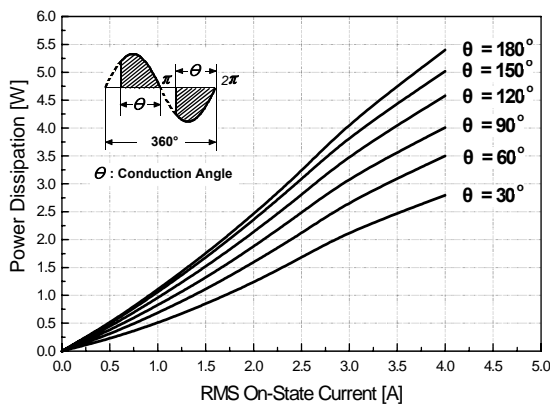
**Fig 1. Gate Characteristics**



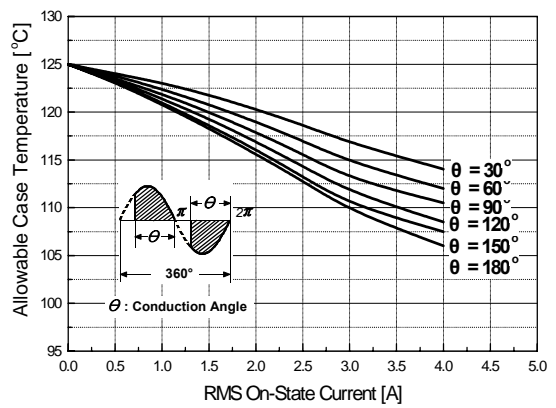
**Fig 2. On-State Voltage**



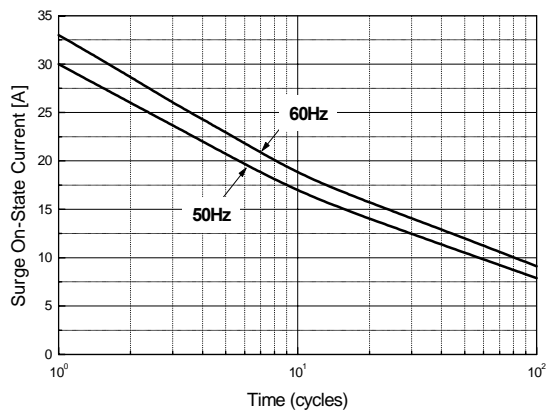
**Fig 3. On State Current vs. Maximum Power Dissipation**



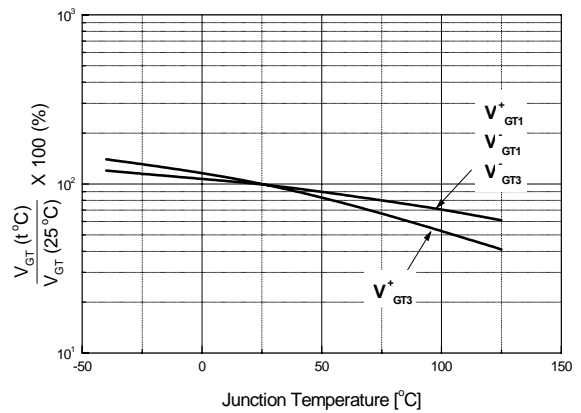
**Fig 4. On State Current vs. Allowable Case Temperature**



**Fig 5. Surge On-State Current Rating ( Non-Repetitive )**

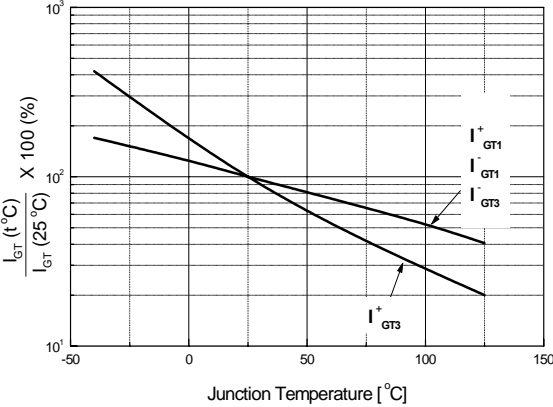


**Fig 6. Gate Trigger Voltage vs. Junction Temperature**

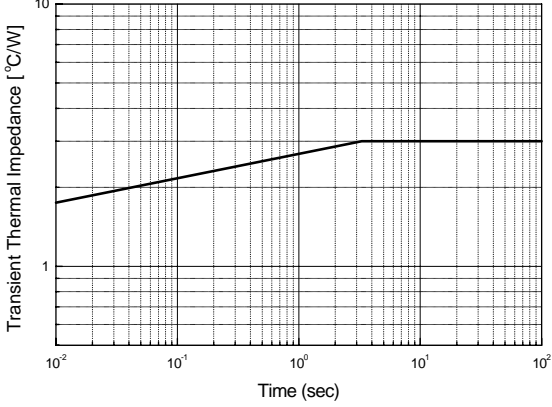


# STP4A60S

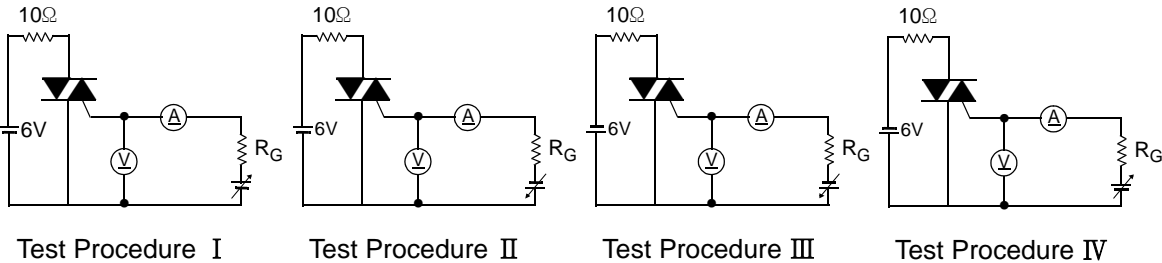
**Fig 7. Gate Trigger Current vs. Junction Temperature**



**Fig 8. Transient Thermal Impedance**



**Fig 9. Gate Trigger Characteristics Test Circuit**



# STP4A60S

## TO-220 Package Dimension

Dim.	mm			Inch		
	Min.	Typ.	Max.	Min.	Typ.	Max.
A	9.7		10.1	0.382		0.398
B	6.3		6.7	0.248		0.264
C	9.0		9.47	0.354		0.373
D	12.8		13.3	0.504		0.524
E	1.2		1.4	0.047		0.055
F		1.7			0.067	
G		2.5			0.098	
H	3.0		3.4	0.118		0.134
I	1.25		1.4	0.049		0.055
J	2.4		2.7	0.094		0.106
K	5.0		5.15	0.197		0.203
L	2.2		2.6	0.087		0.102
M	1.25		1.55	0.049		0.061
N	0.45		0.6	0.018		0.024
O	0.6		1.0	0.024		0.039
$\phi$		3.6			0.142	

