

**STP2001QFP**

July 1997

**SUN MICROELECTRONICS**

# Slave I/O

**DATA SHEET****Integrated SBus Interface Slave I/O Controller**

## DESCRIPTION

The STP2001 Slave I/O Controller is a highly integrated, low-cost, low-power device designed for use in single-processor systems with an SBus interface. The STP2001 provides serial I/O for keyboard, mouse and general-purpose use. In addition, a floppy disk interface, an external byte-wide expansion bus (EBus) for TOD and EPROM, I/O registers and reset control logic are integrated. Together, the STP2001 and the STP2000 Master I/O Controller, provide a complete I/O subsystem.

The two serial ports for keyboard/mouse and general purpose use are compatible with the AMD AM85C30, rev C Serial Communications Controller. The TTY A/B serial ports are fully synchronous, while the keyboard/mouse ports are asynchronous only. All ports support data rates up to 38.4 Kb/s. The NCR82077 floppy disk interface is compatible with the Intel 8077A-1 single-chip floppy controller, supporting up to a 1 MBit/sec transfer rate.

### Features

- Integrates two dual serial controllers, a high-speed floppy controller, uniprocessor interrupt, reset, and counter/timer circuitry, power-down control and an EBus in a single package
- Directly interfaces to CPU through the SBus
- Auxiliary I/O registers (used for LED, floppy and system power-down)
- Interrupt Controller for single-processor SBus system
- System reset control
- Counter/timers for single-processor SBus system
- EBus interface
- JTAG internal and boundary SCAN logic
- 160-pin PQFP packaging
- IC is also available from NCR Corp. (PN - NCR89105)

### Benefits

- Saves cost, power, board space, and weight
- Improved performance
- High level of system integration; ease of design
- High level of system integration; ease of design
- High level of system integration; ease of design
- High level of system integration; ease of design
- Generic 8-bit interface available
- Improved chip and board level testability
- Cost effective packaging
- Second source



Slave I/O  
Integrated SBus Interface Slave I/O Controller

**BLOCK, APPLICATION, AND LOGIC DIAGRAMS**

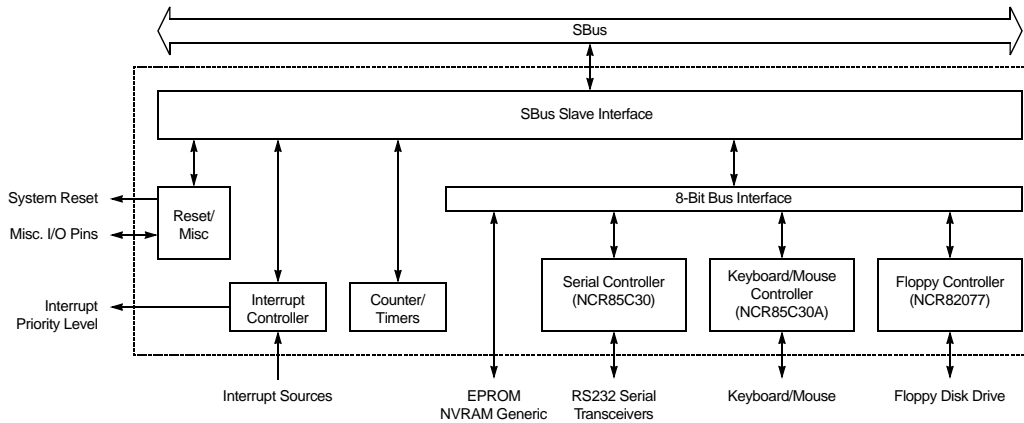

**Figure 1. STP2001 Block Diagram**

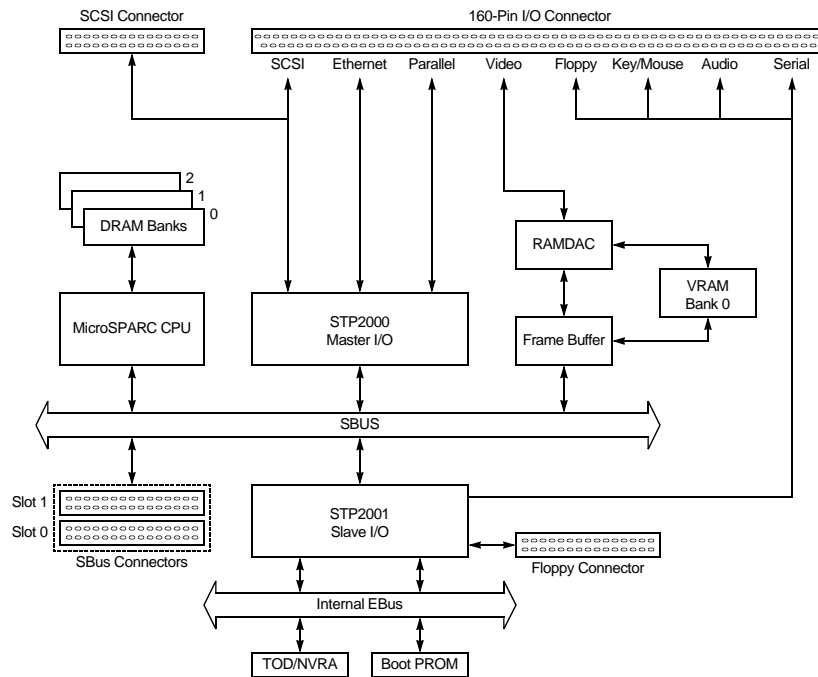

**Figure 2. STP2001 Typical Application**



Slave I/O  
Integrated SBus Interface Slave I/O Controller

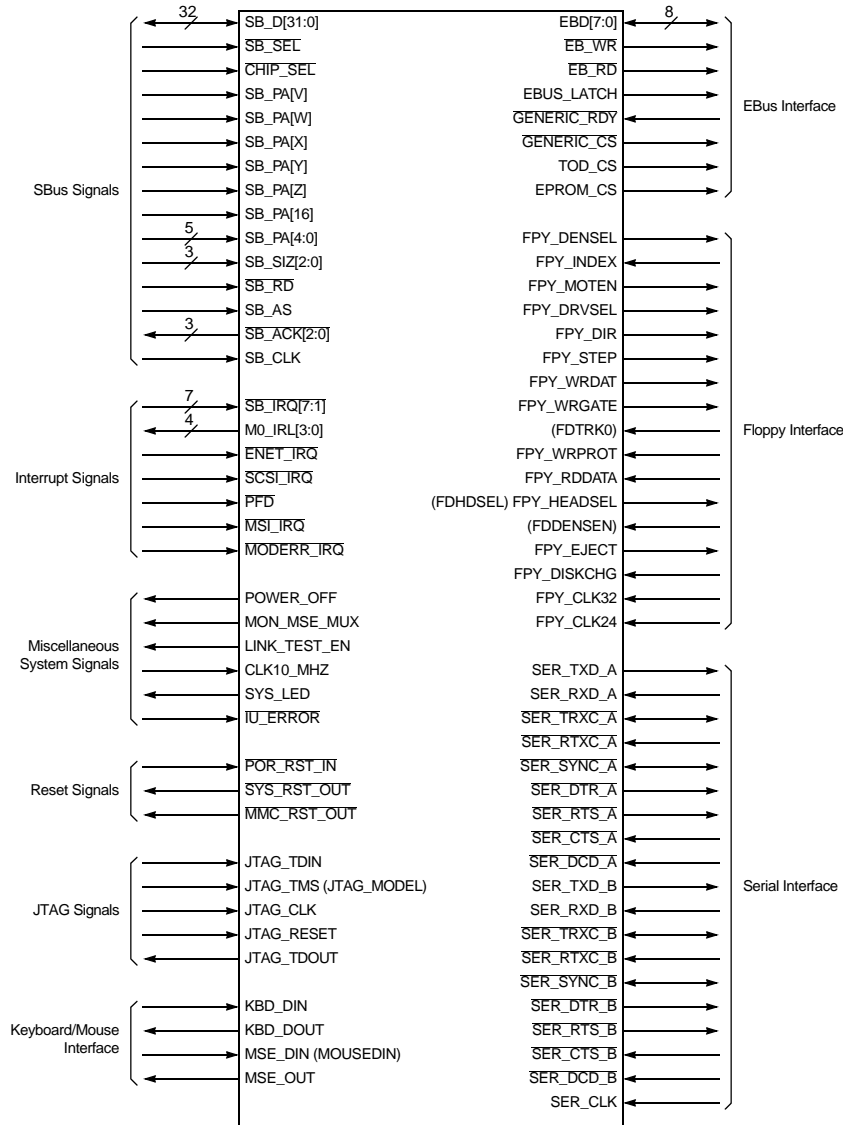

Figure 3. STP2001 Logical Connections

**STP2001QFP**
*Slave I/O  
Integrated SBus Interface Slave I/O Controller*

## SIGNAL DESCRIPTIONS

### SBus Interface: 54 Pins

Signal	Type	Description
SB_D[31:0]	I/O	SBus Data Bus
SB_ACK[2:0]	3-State	SBus Acknowledge
SB_CLK	Input	SBus Clock Input
SB_RD	Input	SBus Read/Write
SB_SEL	Input	SBus Select
SB_SIZ[2:0]	Input	SBus Transfer Size
SB_AS	Input	SBus Address Strobe (address is valid)
CHIP_SEL <sup>[1]</sup>	Input	High order physical address bits (for slave decodes)
SB_PA[V:Z] <sup>[2]</sup>	Input	High order physical address bits (for slave decodes)
SB_PA[16]	Input	PA[16] (for system/user selection in INT/TMR)
SB_PA[4:0]	Input	Low order physical address bits

1. The CHIP\_SEL pin is an additional qualifier (active low) to the SB\_SEL line. When sharing a single SBus select line with another device (such as the STP2000QFP), one of the high order SBus physical address lines, such as PA[27], can be tied to the CHIP\_SEL pin to distinguish between the two devices.
2. In some system configurations, the high order physical address bits can be connected as follows: SB\_A[V, W, X, Y, Z]=PA[24:20].

### EBus Interface: 15 pins

Signal	Type	Description
EB_D[7:0]	I/O	EBus data
EB_ADDRLATCH	Output	EBus address latch
EB_RD	Output	EBus read
EB_WR	Output	Ebus write
TOD_CS	Output	TOD chip select
EPROM_CS	Output	EPROM chip select
GENERIC_CS	Output	Generic port chip select
GENERIC_RDY	Input	Generic port ready (25 $\mu$ A pull-up)

Slave I/O  
Integrated SBus Interface Slave I/O Controller

STP2001QFP

### Floppy Interface: 17 pins

Signal	Type	Description
FPY_CLK32	Input	32 MHz clock for floppy DDS
FPY_CLK24	Input	24 MHz clock for floppy ASF
FPY_DENSENSE	Input	Density sense input (auxio1 register bit)
FPY_DISKCHG	Input	Disk change
FPY_WRPROT	Input	Write protect
FPY_TRACK0	Input	Track 0 indicator
FPY_RDDATA	Input	Read data
FPY_INDEX	Input	Track index
FPY_EJECT	Output	Floppy eject (ME[3] of 82077 ASF)
FPY_HEADSEL	Output	Head select
FPY_STEP	Output	Drive step pulse
FPY_DIR	Output	Head step direction
FPY_WRDATA	Output	Write data
FPY_WRGATE	Output	Write enable
FPY_DRVSEL	Output	Floppy drive select (DS[0] of 82077 ASF)
FPY_MOTEN	Output	Floppy motor enable (ME[0] of 82077 ASF)
FPY_DENSEL	Output	Density select (ME[2] or DENSEL of 82077 ASF)

### Keyboard/Mouse Interface: 4 pins

Signal	Type	Description
KBD_DIN	Input	Keyboard data in
KBD_DOUT	Output	Keyboard data out
MSE_DIN	Input	Mouse data in
MSE_OUT	Output	Mouse data out

### Reset Signals: 3 pins

Signal	Type	Description
POR_RST_IN	Input	Power-up reset input
SYS_RST_OUT	Output	System (SBus) reset output
MMC_RST_OUT	Output	MMC reset output

**STP2001QFP**
*Slave I/O  
Integrated SBus Interface Slave I/O Controller*
**Serial Interface: 19 pins**

Signal	Type	Description
SER_CLK	Input	19.66 MHz serial clock
SER_RTXC_A	Input	Receive/transmit clock A
SER_CTS_A	Input	Clear to send A
SER_RXD_A	Input	Receive data A
SER_DCD_A	Input	Data carrier detect A
SER_DTR_A	Output	Data terminal ready A
SER_TXD_A	Output	Transmit data A
SER_RTS_A	Output	Request to send A
SER_SYNC_A	I/O	Sync IO, A
SER_TRXC_A	I/O	Transmit clock A
SER_RTXC_B	Input	Receive/transmit clock B
SER_CTS_B	Input	Clear to send B
SER_RXD_B	Input	Receive data B
SER_DCD_B	Input	Data carrier detect B
SER_DTR_B	Output	Data terminal ready B
SER_TXD_B	Output	Transmit data B
SER_RTS_B	Output	Request to send B
SER_SYNC_B	I/O	Sync IO, B
SER_TRXC_B	I/O	Transmit clock B

**Interrupt Signals: 16 pins**

Signal	Type	Description
MO_IRL[3:0]	Output	Module 0 encoded interrupt level
SB_IRQ[7:1]	Input	SBus interrupt requests
ENET_IRQ	Input	Ethernet interrupt request
SCSI_IRQ	Input	SCSI interrupt request
PFD	Input	Power fail detect (level 15 interrupt)
MSI_IRQ	Input	MSI interrupt
MODERR_IRQ	Input	Processor level 15 interrupt (async error)

**Miscellaneous System Signals: 6 pins**

Signal	Type	Description
CLK_10MHZ	Input	10 MHz clock for counter/ timer block
MON_MSE_MUX	Output	Monitor/mouse mux select
POWER_OFF	Output	Power off output (to power supply)
LINK_TEST_EN	Output	T7213 link test enable
SYS_LED	Output	System LED output
IU_ERROR	Input	Processor watchdog reset/Video interrupt

**JTAG Signals: 5 pins**

Signal	Type	Description
JTAG_TDO	Output	JTAG test data output
JTAG_TDI	Input	JTAG test data input (100 $\mu$ A pull-up)
JTAG_CLK	Input	JTAG clock
JTAG_TMS	Input	JTAG test mode select (100 $\mu$ A pull-up)
JTAG_RST	Input	JTAG reset (100 $\mu$ A pull-up)

**STP2001QFP**
*Slave I/O  
Integrated SBus Interface Slave I/O Controller*

## ELECTRICAL CHARACTERISTICS

### Absolute Maximum Ratings <sup>[1]</sup>

Symbol	Parameter	Rating	Units
V <sub>CC</sub>	Power supply voltage	7.0	V
V <sub>IN</sub>	Input voltage	0 ≤ V <sub>IN</sub> ≤ V <sub>CC</sub>	V
I <sub>I</sub>	Current Drain V <sub>CC</sub> and GND	100	mA
T <sub>L</sub>	Lead temperature (less than 10 second soldering)	250	°C
T <sub>J</sub>	Operating temperature	0 to +70	°C
T <sub>S</sub>	Storage temperature	-55 to +150	°C
P <sub>D</sub>	Power dissipation	560	mW

1. Operation of the device at values in excess of those listed above will result in degradation or destruction of the device. All voltages are defined with respect to ground. Functional operation of the device at these or any other conditions beyond those indicated under "recommended operating conditions" is not implied. Exposure to absolute-maximum-rated conditions for extended periods may affect device reliability.

### Recommended Operating Conditions

Symbol	Parameter	Min	Typ	Max	Units
V <sub>CC</sub>	Supply voltage	4.75	5.0	5.25	V
T <sub>A</sub>	Operating Temperature	0	25	70	°C
P <sub>D</sub>	Power dissipation	–	280	560	mW

### Capacitance

Symbol	Parameter	Typ	Max	Units
C <sub>IN</sub>	Input capacitance	6	–	pF
C <sub>OUT</sub>	Output capacitance	6	–	pF
C <sub>BI</sub>	Bidirectional pin capacitance	6	–	pF



Slave I/O  
Integrated SBus Interface Slave I/O Controller

STP2001QFP

### DC Characteristics

Symbol	Parameter	Min	Typ	Max	Units	
$V_{IH}$	Input high voltage	2.0	–	–	V	
$V_{IL}$	Input Low voltage	–	–	0.8	V	
$V_{OH}$	High level output voltage	4.4	4.5	–	V	
$V_{OL}$	Low level output voltage	–	0	0.1	V	
$I_{IN}$	Input leakage current	-10	–	10	$\mu$ A	
$I_{OH}$	High level source current ( $V_{OH} = 2.4$ V)	$I_{OH} = 2.0$ mA	2	–	–	mA
		$I_{OH} = 4.0$ mA	4	–	–	mA
		$I_{OH} = 8.0$ mA	8	–	–	mA
		$I_{OH} = 16.0$ mA	16	–	–	mA
		$I_{OH} = 24.0$ mA	24	–	–	mA
$I_{OL}$	Low level sink current ( $V_{OL} = 0.4$ V)	$I_{OL} = -2.0$ mA	2	–	–	mA
		$I_{OL} = -4.0$ mA	4	–	–	mA
		$I_{OL} = -8.0$ mA	8	–	–	mA
		$I_{OL} = -16.0$ mA	16	–	–	mA
		$I_{OL} = -24.0$ mA	24	–	–	mA
		$I_{OL} = -48.0$ mA	48	–	–	mA
		SCSIPAD ( $V_{OL} = 0.5$ V)	48	–	–	mA
SCSIPADF ( $V_{OL} = 0.5$ V)	48	–	–	mA		
$I_{OZ}$	Hi-Z output leakage current	-10	–	10	$\mu$ A	

**STP2001QFP**
*Slave I/O  
Integrated SBus Interface Slave I/O Controller*
**AC Characteristics: SBus Timing**

Signal #	Parameter	Conditions	Min	Max	Units
$f_{SB}$	SBus clock frequency		16.7	25.0	ns
1	Clock period		40.0	60.0	ns
2	Clock high		17.0	–	ns
3	Clock low		17.0	–	ns
4	Hold WRT CLK rising		0.0	–	ns
5	Setup to CLK rising		15.0	–	ns
6	Setup to CLK rising		15.0	–	ns
7	Hold WRT CLK rising <sup>[1]</sup>		–	1.0	ns
8	CLK rising to output valid	100 pF load	–	22.5	ns
9	CLK rising to output invalid	100 pF load	–	22.5	ns
10	CLK rising to output valid	100 pF load	–	22.5	ns
11	CLK rising to output invalid	100 pF load	2.5	25.0	ns
12	CLK rising to output low	100 pF load	–	22.5	ns
13	CLK rising to output high	100 pF load	–	22.5	ns

1. This is the only violation of SBus Specification B.0. No known implementation to date provides less than 1.0 ns hold time on these signals.

**AC Characteristics: EBus Timing**

Signal #	Parameter	Conditions	Min	Max	Units
14	Setup to CLK rising		15.0	–	ns
15	Hold WRT CLK rising		–	2.0	ns
16	CLK rising to output valid	100 pF load	–	22.5	ns
17	CLK rising to output invalid	100 pF load	–	22.5	ns
18	CLK rising to output valid	100 pF load	–	22.5	ns

**AC Characteristics: Miscellaneous Timing**

Signal #	Parameter	Conditions	Min	Max	Units
19	CLK rising to output valid	100 pF load	–	22.5	ns
20	10 MHz clock period <sup>[1]</sup>		50	–	ns

1. This clock must be run at 10 MHz (100 ns period) for correct software operation.



Slave I/O  
Integrated SBus Interface Slave I/O Controller

**AC Characteristics: Floppy Controller Timing**

Signal #	Parameter	Conditions	Min	Max	Units
21	FPY_CLK32 clock period <sup>[1]</sup>		31.3	31.3	ns
22	FPY_CLK24 clock high time		16.7	25	ns
23	FPY_CLK24 clock low time		16.7	25	ns
24	FPY_CLK24 clock period <sup>[1]</sup>		41.7	41.7	ns
25	Internal clock period (t <sub>Cl</sub> ) <sup>[2]</sup>		62.5	250	ns
26	FPY_DIR change to FPY_STEP setup time		1.0	–	μs
27	FPY_STEP pulse width		7	8	μs
28	FPY_STEP rate <sup>[3]</sup>		1	15	ms
29	FPY_INDEX pulse width		4	–	t <sub>Cl</sub>
30	FPY_RDDATA pulse width		50	–	ns
31	FPY_RDDATA data rate <sup>[4]</sup>		250 K	1 M	bit/s
32	FPY_WRGATE to FPY_WRDATA setup time		250	–	ns
33	FPY_WRDATA pulse width <sup>[5]</sup>		125	500	ns

1. The NCR82077 core uses a digital data separator to read the data off of the disk. Any variation from the nominal input clock frequencies will shift the capture range of the cell.

2. NOTE 4: Internal clock period is a function of the selected data rate.

Data Rate	Frequency	Period
1 Mbs	16 MHz	62.5 ns
500 Kbs	8 MHz	125 ns
300 Kbs	4.8 MHz	208 ns
250 Kbs	4 MHz	250 ns

3. FPY\_STEP Rate time is selected by a SPECIFY command. Failure to issue a specify command before issuing a Recalibrate or Seek command or implied seek will cause unpredictable results.

4. FPY\_RDDATA data rate is determined by the floppy tape drive or tape drive. The values are:

- 1 Mbs – 1.0 μs minimum
- 500 Kbs – 2.0 μs minimum
- 300 Kbs – 3.3 μs minimum
- 250 Kbs – 4.0 μs minimum

5. FPY\_WRDATA pulse width is based on the selected data rate. The values are 2 x t<sub>Cl</sub>:

- 1 Mbs - 2 x 62.5 = 125 ns
- 500 Kbs - 2 x 125 = 250 ns
- 300 Kbs - 2 x 208 = 416 ns
- 250 Kbs - 2 x 250 = 500 ns

**STP2001QFP**
*Slave I/O  
Integrated SBus Interface Slave I/O Controller*
**AC Characteristics: Serial/Keyboard/Mouse Controllers Timing**

Signal #	Parameter	Conditions	Min	Max	Units
34	SER_CLK low width <sup>[1]</sup>		50	–	ns
35	SER_CLK high width		50	–	ns
36	SER_CLK cycle time ( $t_{PC}$ )		122	–	ns
37	SER_RT $\overline{X}$ C width		150	–	ns
38	SER_RT $\overline{X}$ C cycle time		4	–	$t_{PC}$
39	SER_TR $\overline{X}$ C width		150	–	ns
40	SER_TR $\overline{X}$ C cycle time		4	–	$t_{PC}$
41	SER_DCD or SER_CTS width		200	–	ns
42	SER_SYNC $\overline{C}$ width		200	–	ns
43	SER_RXD to SER_RT $\overline{X}$ C setup time		0	–	ns
44	SER_RXD to SER_RT $\overline{X}$ C hold time		150	–	ns
45	SER_SYNC $\overline{C}$ to SER_RT $\overline{X}$ C setup time		-200	–	ns
46	SER_SYNC $\overline{C}$ to SER_RT $\overline{X}$ C hold time		5	–	$t_{PC}$
47	SER_TR $\overline{X}$ C to SER_TXD delay		–	200	ns
48	SER_TXD to SER_TR $\overline{X}$ C delay		–	200	ns

1. The input SER\_CLK is used to clock the serial controllers and the keyboard/mouse controller. The timing numbers in this section apply to both of these controllers.



Slave I/O  
Integrated SBus Interface Slave I/O Controller

**TIMING DIAGRAMS**

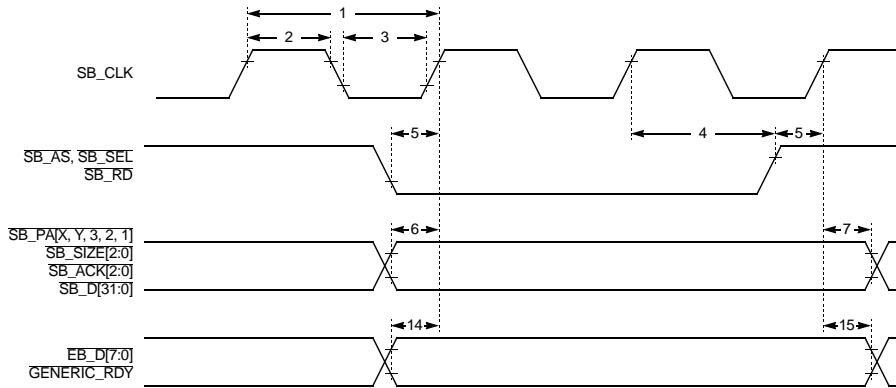

**Figure 4. SBus/EBus Input Timing**

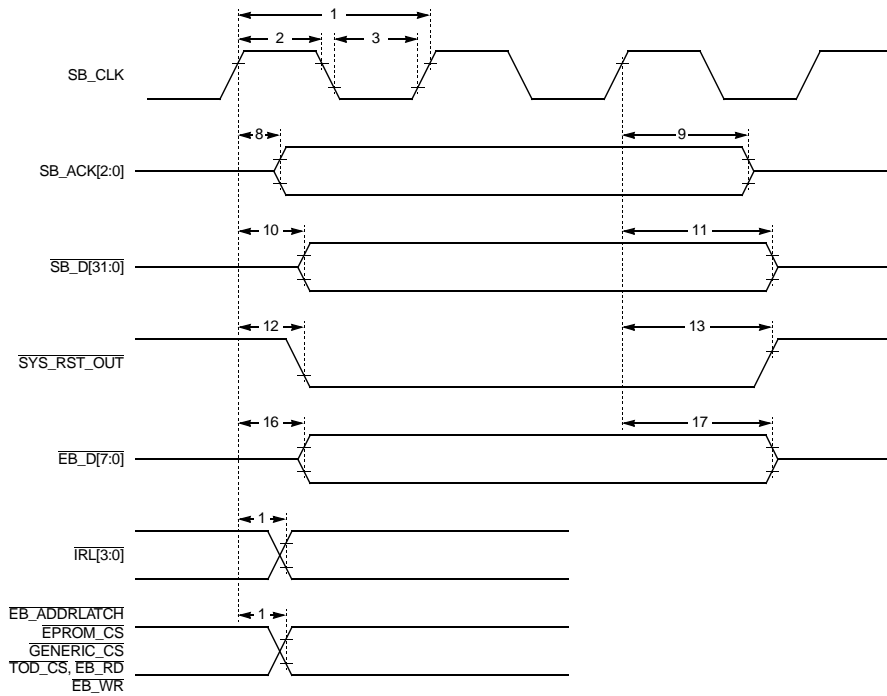

**Figure 5. SBus/EBus Output Timing**



Slave I/O  
Integrated SBus Interface Slave I/O Controller

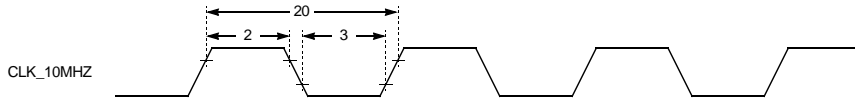

Figure 6. Counter/Timer Input Clock

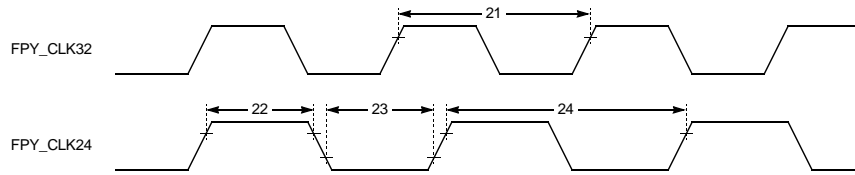

Figure 7. Floppy Controller Clock Inputs

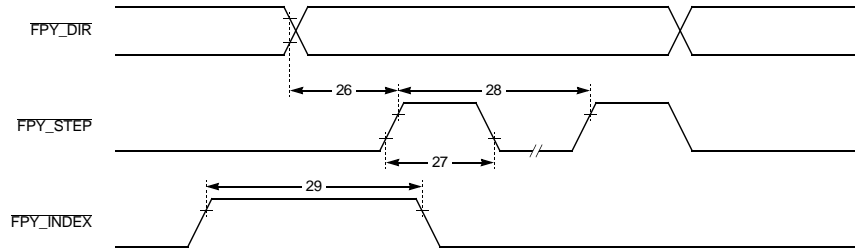

Figure 8. Floppy Drive Interface Timing

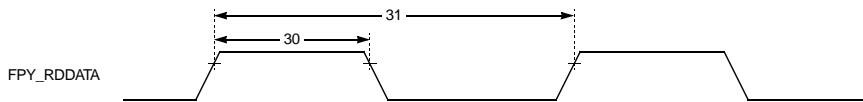

Figure 9. Floppy Read Data

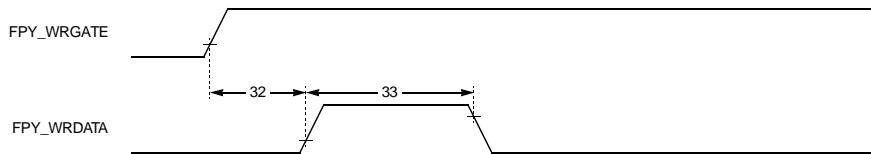

Figure 10. Floppy Write Data

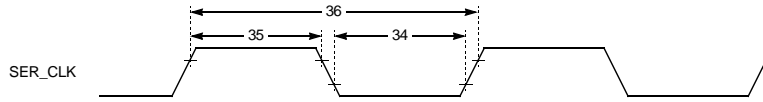

Figure 11. Serial/Keyboard/Mouse Clock Input

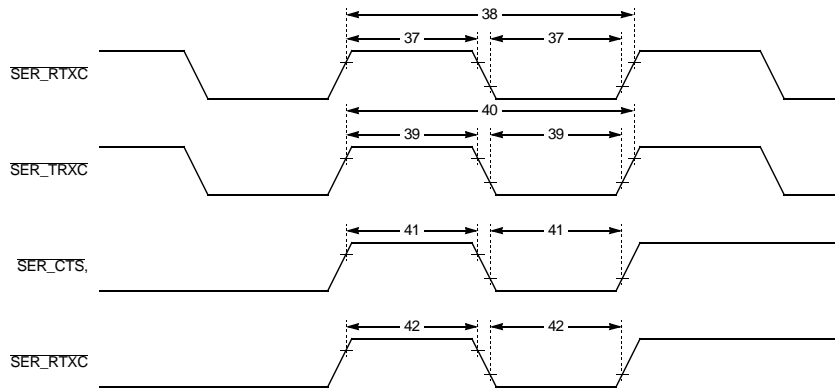

Figure 12. Serial Pulse Widths

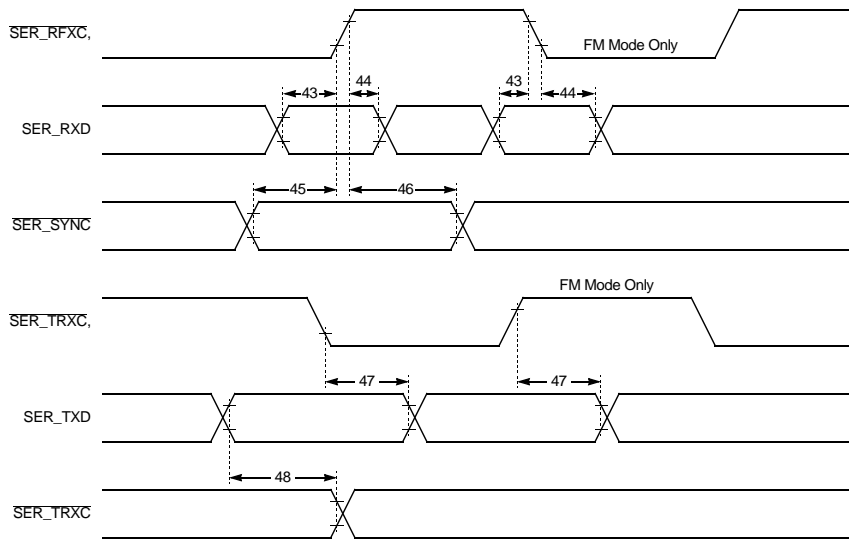



Figure 13. Serial Data Timing

**STP2001QFP**
*Slave I/O  
Integrated SBus Interface Slave I/O Controller*

## PACKAGE INFORMATION

### 160-Pin PQFP Pin Assignment

Pin	Signal Name	Pin	Signal Name	Pin	Signal Name	Pin	Signal Name	Pin	Signal Name
1	ENET_IRQ	33	SB_PA[y]	65	SB_D[19]	97	SER_DTR_B	129	TOD_CS
2	SCSI_IRQ	34	SB_PA[x]	66	SB_D[20]	98	SER_SYNC_B	130	EB_RD
3	FPY_DENSENSE	35	SB_PA[w]	67	SB_D[21]	99	KBD_DOUT	131	EB_WR
4	FPY_DISKCHG	36	SB_PA[v]	68	VCC	100	MSE_OUT	132	EB_D[0]
5	FPY_WRPROT	37	GND	69	SB_D[22]	101	POWER_OFF	133	GND
6	FPY_TRACK0	38	CHIP_SEL	70	SB_D[23]	102	JTAG_TDO	134	EB_D[1]
7	FPY_RDDATA	39	SB_RD	71	SB_D[24]	103	VCC	135	EB_D[2]
8	FPY_INDEX	40	SB_AS	72	SB_D[25]	104	SER_CLK	136	EB_D[3]
9	FPY_CLK24	41	SB_SEL	73	SB_D[26]	105	SER_RTXC_B	137	EB_D[4]
10	GND	42	SB_D[0]	74	SB_D[27]	106	SER_CTS_B	138	EB_D[5]
11	FPY_EJECT	43	SB_D[1]	75	GND	107	GND	139	EB_D[6]
12	FPY_HEADSEL	44	SB_D[2]	76	SB_D[28]	108	SER_RXD_B	140	VCC
13	FPY_STEP	45	SB_D[3]	77	SB_D[29]	109	SER_DCD_B	141	EB_D[7]
14	FPY_DIR	46	GND	78	SB_D[30]	110	SER_RTXC_A	142	EB_ADDR LATCH
15	GND	47	SB_D[4]	79	SB_D[31]	111	SER_CTS_A	143	SYS_RST_OUT
16	FPY_WRDATA	48	SB_D[5]	80	SB_SIZ[2]	112	VCC	144	MMC_RST_OUT
17	FPY_WRGATE	49	SB_D[6]	81	SB_SIZ[1]	113	SER_RXD_A	145	MO_IRL[0]
18	FPY_DRVSEL	50	SB_D[7]	82	SB_SIZ[0]	114	SER_DCD_A	146	MO_IRL[1]
19	VCC	51	SB_D[8]	83	GND	115	LINK_TEST_EN	147	GND
20	FPY_MOTEN	52	SB_D[9]	84	SB_ACK[2]	116	MSE_DIN	148	MO_IRL[2]
21	FPY_DENSEL	53	VCC	85	SB_ACK[1]	117	KBD_DIN	149	MO_IRL[3]
22	VCC	54	SB_D[10]	86	SB_ACK[0]	118	MON_MSE_MUX	150	CLK_10MHZ
23	FPY_CLK32	55	SB_D[11]	87	SER_DTR_A	119	JTAG_TDI	151	SB_IRQ[1]
24	SB_PA[0]	56	SB_D[12]	88	SER_TXD_A	120	JTAG_CLK	152	SB_IRQ[2]
25	SB_PA[1]	57	SB_D[13]	89	GND	121	JTAG_TMS	153	SB_IRQ[3]
26	SB_PA[2]	58	SB_D[14]	90	SER_RTS_A	122	JTAG_RST	154	SB_IRQ[4]
27	GND	59	SB_D[15]	91	SER_SYNC_A	123	GENERIC_RDY	155	SB_IRQ[5]
28	SB_PA[3]	60	GND	92	SER_TRXC_A	124	IU_ERROR	156	SB_IRQ[6]
29	SB_PA[4]	61	SB_CLK	93	SER_TXD_B	125	POR_RST_IN	157	SB_IRQ[7]
30	SB_PA[16]	62	SB_D[16]	94	SER_TRXC_B	126	GENERIC_CS	158	PFD
31	SB_PA[2]	63	SB_D[17]	95	VCC	127	SYS_LED	159	MODERR_IRQ
32	VCC	64	SB_D[18]	96	SER_RTS_B	128	EPROM_CS	160	MSI_IRQ





Slave I/O  
Integrated SBus Interface Slave I/O Controller

**160-Pin PQFP Package Dimensions**

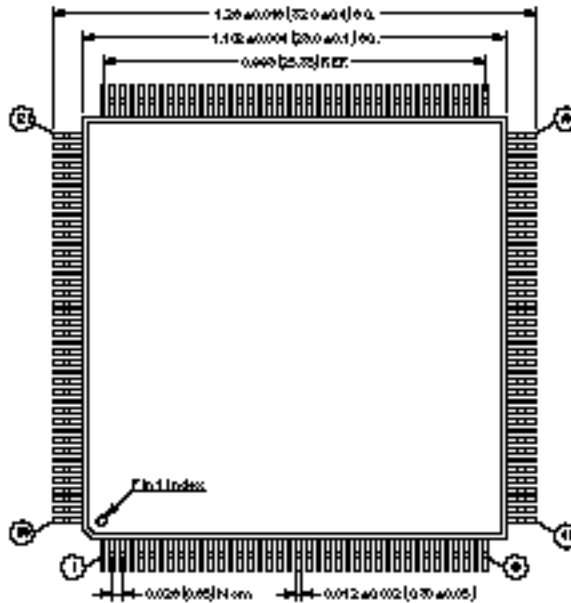
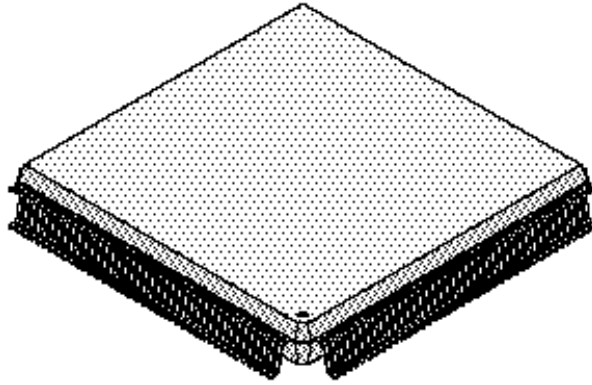

Dimensions in inches, dimensions in brackets in millimeters



*Slave I/O*  
*Integrated SBus Interface Slave I/O Controller*

### ORDERING INFORMATION

Part Number	Description
STP2001QFP	160-Pin Plastic Leaded Chip Carrier (PQFP)

Document Part Number: STP2001

