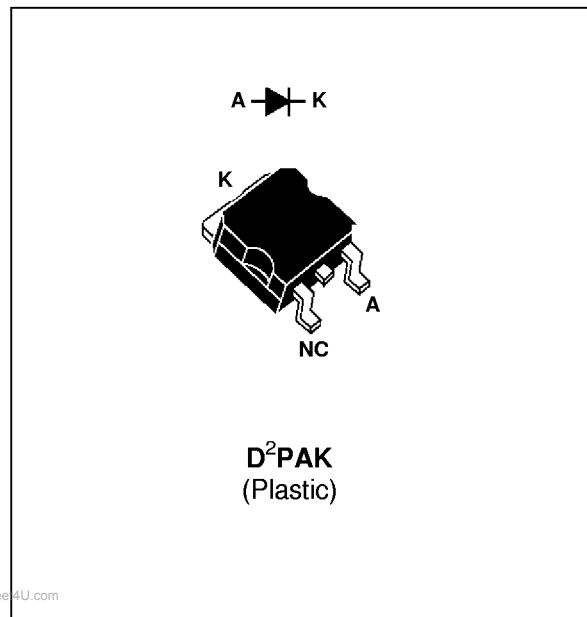


**TURBOSWITCH™ "B" ULTRA-FAST HIGH VOLTAGE DIODE**
**MAIN PRODUCT CHARACTERISTICS**

$I_{F(AV)}$	<b>12A</b>
$V_{RRM}$	<b>600V</b>
$t_{rr}$ (typ)	<b>50ns</b>
$V_F$ (max)	<b>1.3V</b>

**FEATURES AND BENEFITS**

- SPECIFIC TO THE FOLLOWING OPERATIONS: Snubbing or clamping, demagnetization and rectification.
- ULTRA-FAST, VERY SOFT AND NOISE-FREE RECOVERY.
- VERY LOW OVERALL POWER LOSSES AND PARTICULARLY LOW FORWARD VOLTAGE.
- DESIGNED FOR HIGH PULSED CURRENT OPERATIONS.
- HIGH FREQUENCY OPERATIONS
- SMD



www.DataSheet4U.com

**DESCRIPTION**

The TURBOSWITCH is a very high performance series of ultra-fast high voltage power diodes from 600V to 1200V.

TURBOSWITCH, B family, drastically cuts losses in all high voltage operations which require extremely fast, soft and noise-free power diodes. They are particularly suitable in the primary circuit

of an SMPS as snubber, clamping or demagnetizing diodes, and also in most power converters as high performance rectifier diodes. Packaged in D<sup>2</sup>PAK, this 600V device is particularly intended for use on 240V domestic mains.

**ABSOLUTE MAXIMUM RATINGS**

Symbol	Parameter	Value	Unit
$V_{RRM}$	Repetitive peak reverse voltage	600	V
$V_{RSM}$	Non repetitive peak reverse voltage	600	V
$I_{F(RMS)}$	RMS forward current	30	A
$I_{FRM}$	Repetitive peak forward current ( $t_p = 5 \mu s$ , $f = 1 kHz$ )	420	A
$T_j$	Max operating junction temperature	- 65 to + 150	°C
$T_{stg}$	Storage temperature	- 65 to + 150	°C

TM: TURBOSWITCH is a trademark of SGS-THOMSON Microelectronics.

## STTB1206G

### THERMAL AND POWER DATA

Symbol	Parameter	Conditions	Value	Unit
$R_{th(j-c)}$	Junction to case thermal resistance		1.9	°C/W
$P_1$	Conduction power dissipation (see fig. 5)	$I_{F(AV)} = 12A$ $\delta = 0.5$ $T_c = 114^\circ C$	19	W
$P_{max}$	Total power dissipation $P_{max} = P_1 + P_3$ ( $P_3 = 10\% P_1$ )	$T_c = 104^\circ C$	24	W

### STATIC ELECTRICAL CHARACTERISTICS (see Fig.5)

Symbol	Parameter	Test Conditions	Min	Typ	Max	Unit
$V_F$ *	Forward voltage drop	$I_F = 12A$ $T_j = 25^\circ C$			1.4	V
		$T_j = 125^\circ C$			1.3	
$I_R$ **	Reverse leakage current	$V_R = 0.8$ $\times V_{RRM}$ $T_j = 25^\circ C$			100	$\mu A$
		$T_j = 125^\circ C$			2.0	mA

Test pulses widths : \*  $t_p = 380 \mu s$ , duty cycle < 2%

\*\*  $t_p = 5 ms$ , duty cycle < 2%

### DYNAMIC ELECTRICAL CHARACTERISTICS TURN-OFF SWITCHING (see Fig.6)

[www.DataSheet4U.com](http://www.DataSheet4U.com)

Symbol	Parameter	Test Conditions	Min	Typ	Max	Unit
$t_{rr}$	Reverse recovery time	$T_j = 25^\circ C$ $I_F = 0.5 A$ $I_R = 1A$ $I_{rr} = 0.25A$ $I_F = 1 A$ $di_F/dt = -50A/\mu s$ $V_R = 30V$		50	100	ns
$I_{RM}$	Maximum reverse recovery current	$T_j = 125^\circ C$ $V_R = 400V$ $I_F = 12A$ $di_F/dt = -96 A/\mu s$ $di_F/dt = -500 A/\mu s$		30	18	A
S factor	Softness factor	$T_j = 125^\circ C$ $V_R = 400V$ $I_F = 12A$ $di_F/dt = -500 A/\mu s$		0.9		/

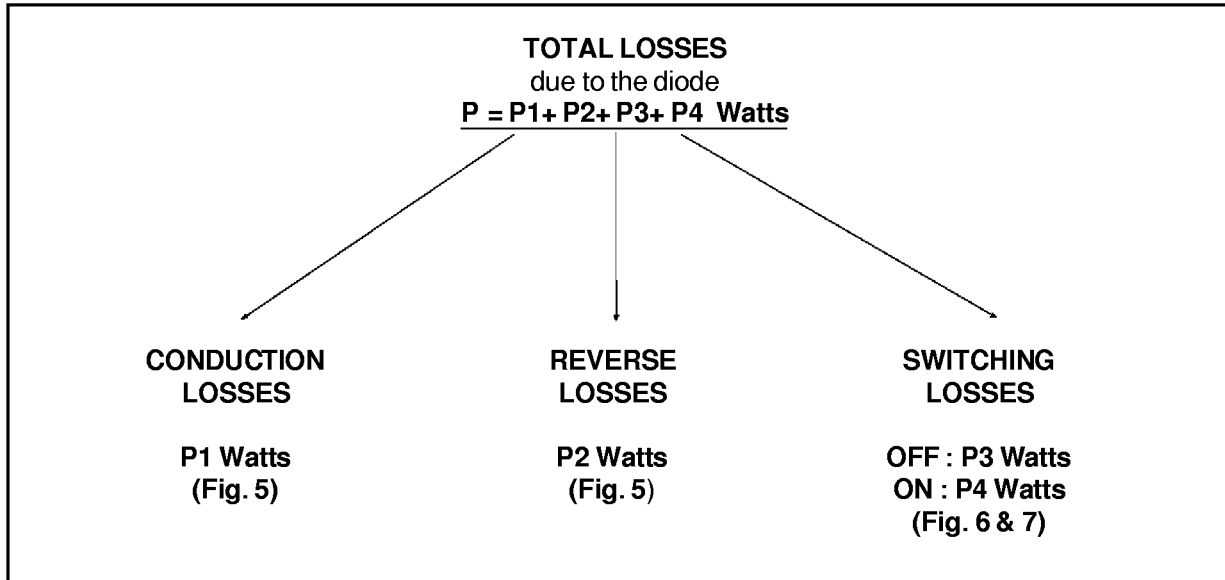
### TURN-ON SWITCHING (see Fig.7)

Symbol	Parameter	Test Conditions	Min	Typ	Max	Unit
$t_{fr}$	Forward recovery time	$T_j = 25^\circ C$ $I_F = 12A$ , $di_F/dt = 96 A/\mu s$ measured at, $1.1 \times V_{Fmax}$			500	ns
$V_{Fp}$	Peak forward voltage	$T_j = 25^\circ C$ $I_F = 12A$ , $di_F/dt = 96 A/\mu s$			8	V

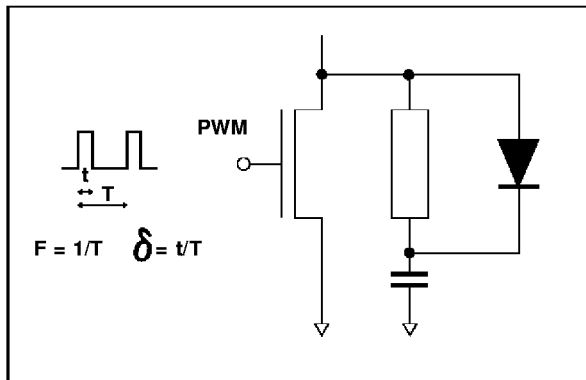
**APPLICATION DATA**

The TURBOSWITCH "B" is especially designed to provide the lowest overall power losses in any application such as snubbing, clamping, demagne-

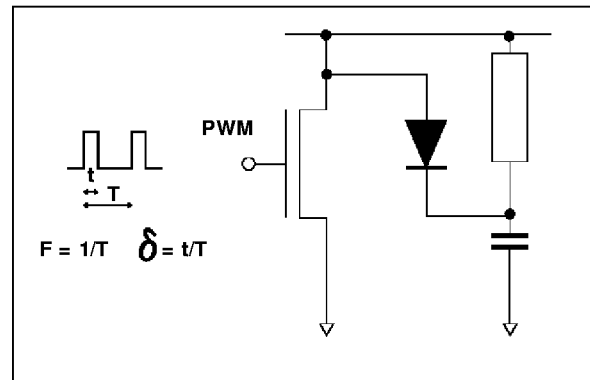
tization and rectification. In such applications (fig.1 to fig.4), the way of calculating the power losses is given below :



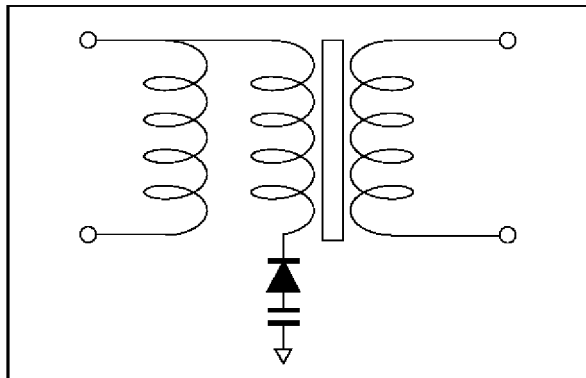
**Fig. 1 : SNUBBER DIODE.**



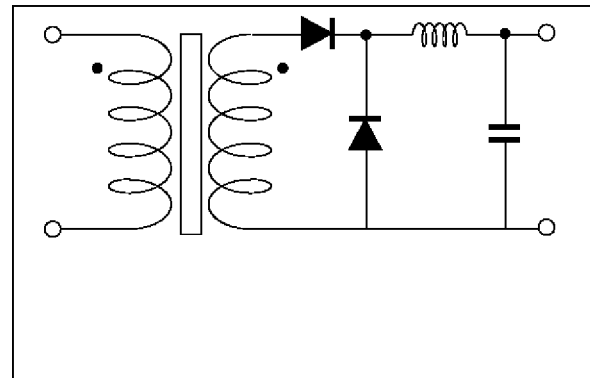
**Fig. 2 : CLAMPING DIODE.**



**Fig. 3 : DEMAGNETIZING DIODE.**

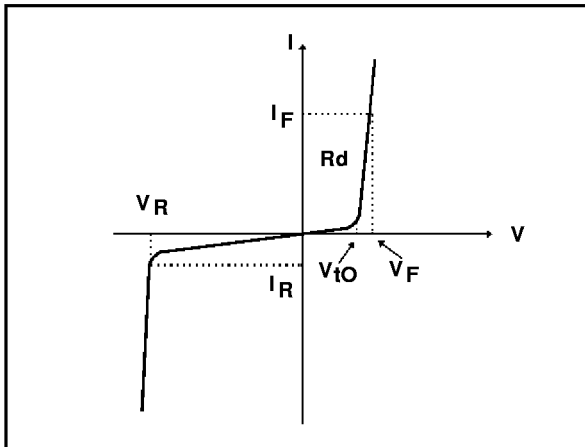


**Fig. 4 : RECTIFIER DIODE.**



APPLICATION DATA (Cont'd)

Fig. 5: STATIC CHARACTERISTICS



Conduction losses :

$$P1 = V_{t0} \cdot I_F(AV) + R_d \cdot I_F^2(RMS)$$

with

$$V_{t0} = 1.00 \text{ V}$$

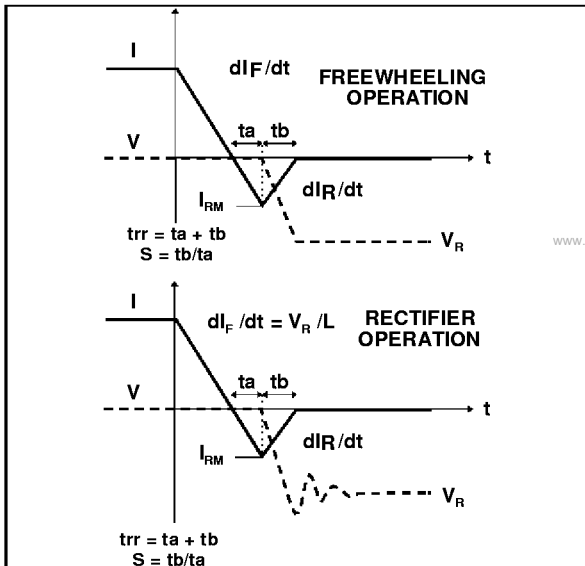
$$R_d = 0.025 \text{ Ohm}$$

(Max values at 125°C)

Reverse losses :

$$P2 = V_R \cdot I_R \cdot (1 - \delta)$$

Fig. 6: TURN-OFF CHARACTERISTICS



Turn-off losses :

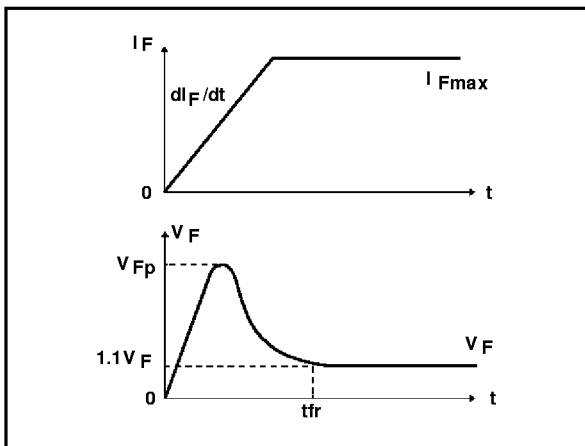
$$P3 = \frac{V_R \times I_{RM}^2 \times S \times F}{6 \times dI/dt}$$

Turn-off losses :  
(with non negligible serial inductance)

$$P3' = \frac{V_R \times I_{RM}^2 \times S \times F}{6 \times dI/dt} + \frac{L \times I_{RM}^2 \times F}{2}$$

P3 and P3' are suitable for power MOSFET and IGBT

Fig. 7: TURN-ON CHARACTERISTICS



Turn-on losses :

$$P4 = 0.4 (V_{FP} - V_F) \cdot I_{Fmax} \cdot t_{tr} \cdot F$$

Fig 8 : Conduction losses versus average current

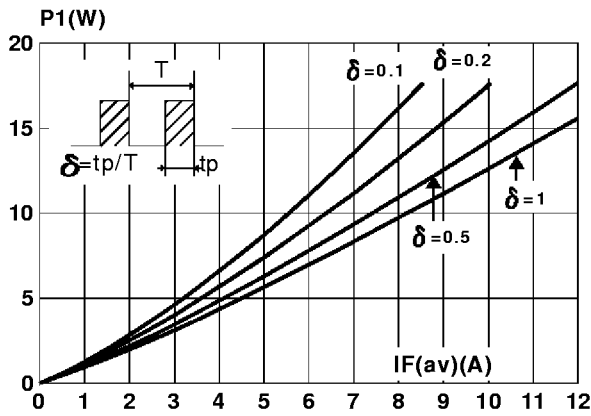


Fig 9 : Switching OFF losses versus  $dI/dt$

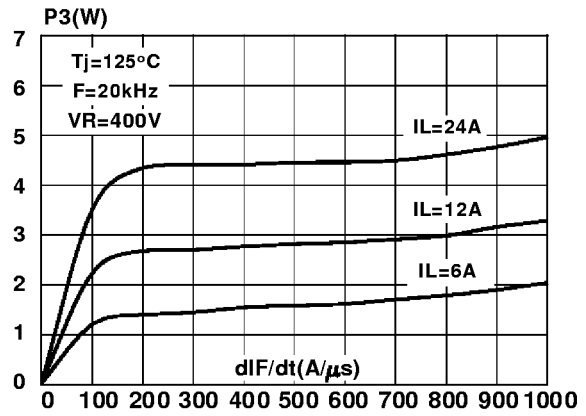


Fig 10 : Switching ON losses versus  $dI/dt$

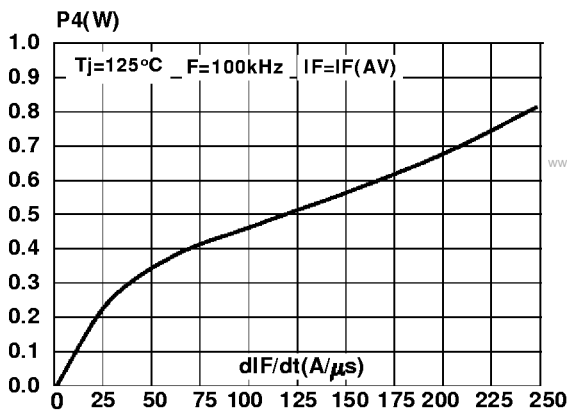


Fig 11 : Forward voltage drop versus forward current

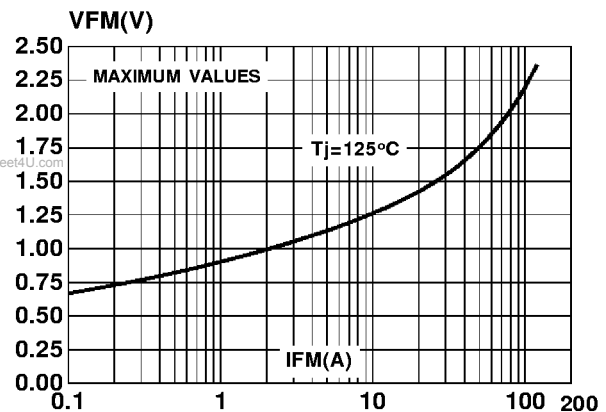


Fig 12 : Relative variation of thermal transient impedance junction to case versus pulse duration

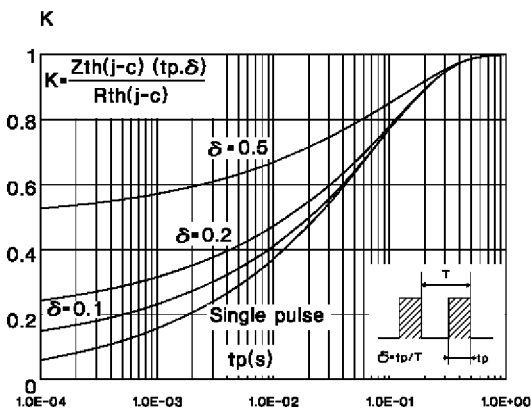


Fig 13 : Peak reverse recovery current versus  $dI_F/dt$

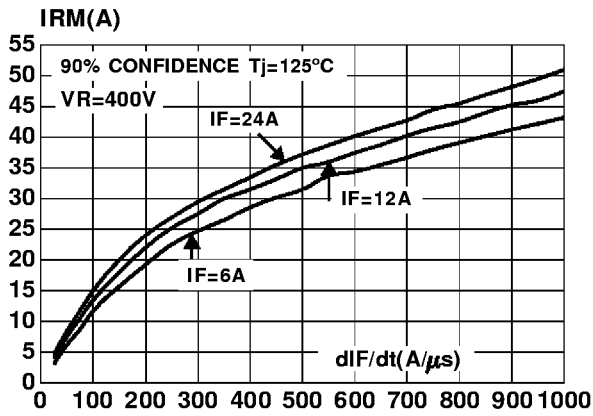


Fig 14 : Reverse recovery time versus  $dI_F/dt$

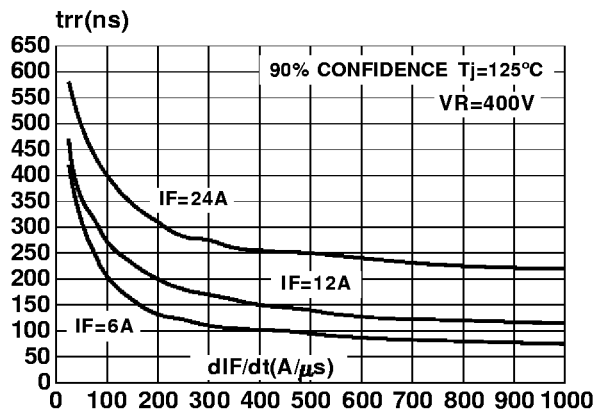


Fig 15 : Softness factor (tb/ta) versus  $dI_F/dt$

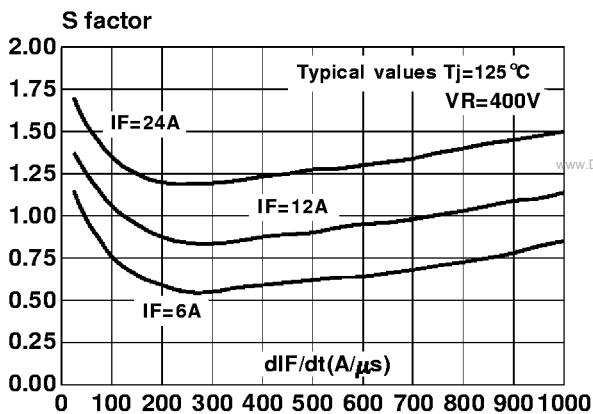


Fig 16 : Relative variation of dynamic parameters versus junction temperature (Reference  $T_j=125^\circ\text{C}$ )

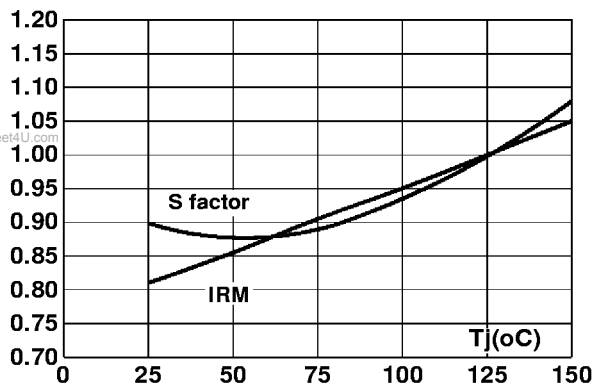


Fig 17 : Transient peak forward voltage versus  $dI_F/dt$

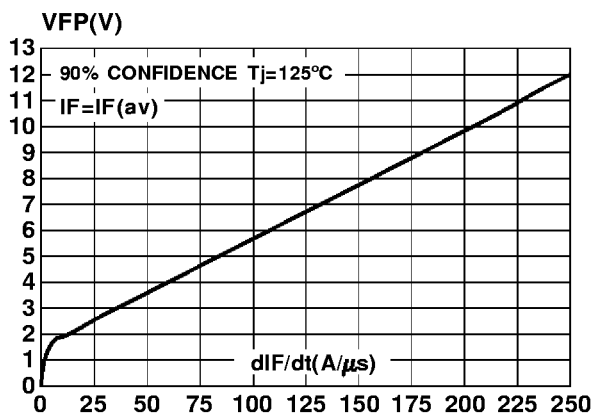
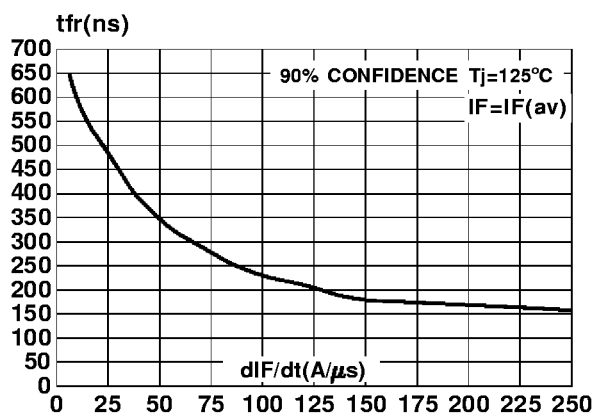
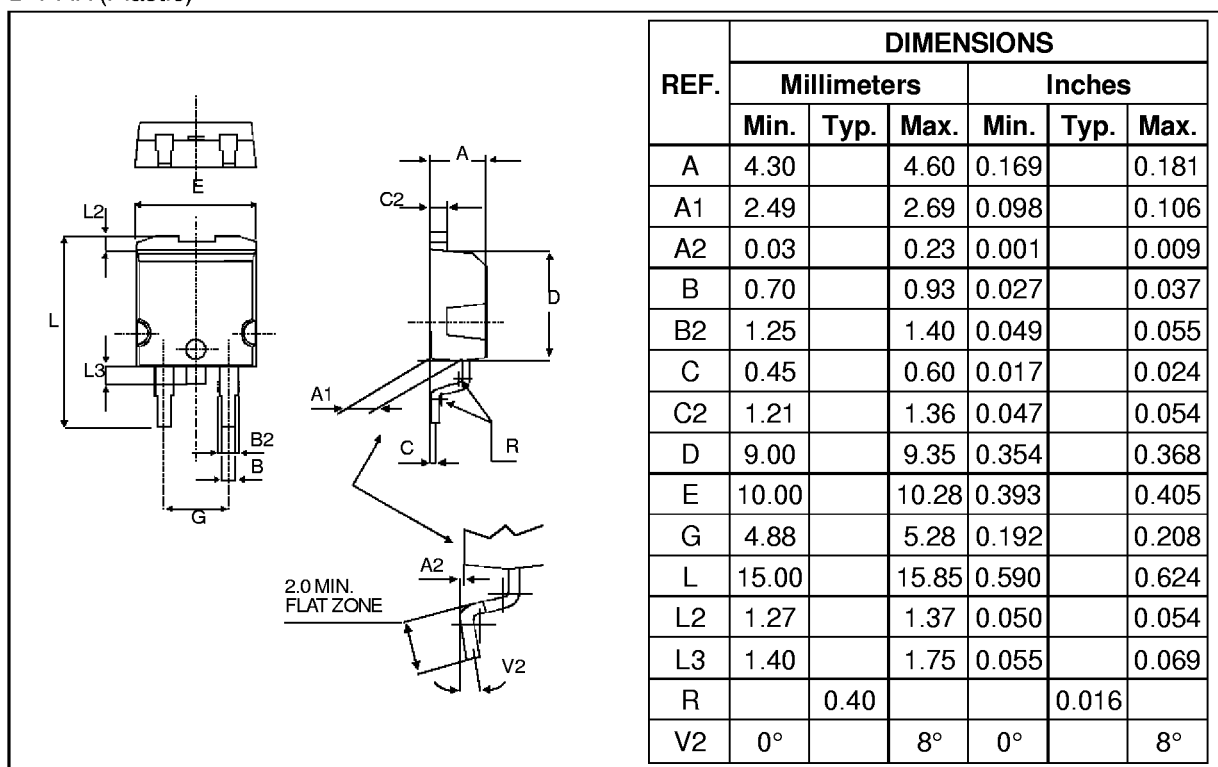


Fig 18 : Forward recovery time versus  $dI_F/dt$



**PACKAGE MECHANICAL DATA**  
**D<sup>2</sup>PAK (Plastic)**


www.DataSheet4U.com

Information furnished is believed to be accurate and reliable. However, SGS-THOMSON Microelectronics assumes no responsibility for the consequences of use of such information nor for any infringement of patents or other rights of third parties which may result from its use. No license is granted by implication or otherwise under any patent or patent rights of SGS-THOMSON Microelectronics. Specifications mentioned in this publication are subject to change without notice. This publication supersedes and replaces all information previously supplied. SGS-THOMSON Microelectronics products are not authorized for use as critical components in life support devices or systems without the express written approval of SGS-THOMSON Microelectronics.

© 1996 SGS-THOMSON Microelectronics - Printed in France - All rights reserved.

SGS-THOMSON Microelectronics Group of Companies

 Australia - Brazil - Canada - China - France - Germany - Hong Kong - Italy - Japan - Korea - Malaysia - Malta - Morocco -  
 The Netherlands - Singapore - Spain - Sweden - Switzerland - Taiwan - Thailand - United Kingdom - U.S.A.