

Description

The B4150 series are a group of positive output voltage, five-pin regulators, which provide a high current even when the input/output voltage differential is small. Low power consumption and high accuracy is achieved through CMOS and programmable fuse technologies. Output voltage: 2.0V to 6.0V in 0.1V increments.

The B4150 consists of a high-precision voltage reference, an error correction circuit, and a current limited output driver. Key features include a Shutdown Pin that reduces supply current to 0.5µA max and a 470pF Bypass input to ground reduces noise present on the internal reference, which in turn significantly reduce output noise. If output noise is not concern, this input maybe left unconnected. Larger capacitor values cap be used, but results in longer time period to rated output voltage when power initially applied.

The ON/OFF pin enables the output to be turned off, resulting in reduced power consumption. Provided in SOT-25 (150mW) packages minimizes the usage of board real state.

Features

- **Maximum output current:..... 150 mA.**
- **Highly accurate: Output voltage..... +/- 1.4%.**
- **Shutdown Supply Current.....0.1µA**
- **Ground Current of Less than..... 2µA**
- **CMOS low power consumption.**
0.165V at 150mA
0.110V at 100mA
- **Low Output Noise: 30µVrms**
- **High Ripple Rejection: 70dB(10kHz)**
- **Shut Down Mode for Power Savings**
- **Reference Bypass for Ultra Low Noise**
- **Improve pin-to-pin TC1185/XC6204/S-814**
- **Pin-to-Pin Low Power to Bipolar LDO's**
MIC5205 / LP2985/LT1761

Applications

- **Battery Powered Equipment**
- **Notebook PC, Palmtops, PDA**
- **Portable Cameras and Video Recorders**
- **Reference Voltage Sources**
- **Cellular / GSM / PCS Phones**

Pin Connection

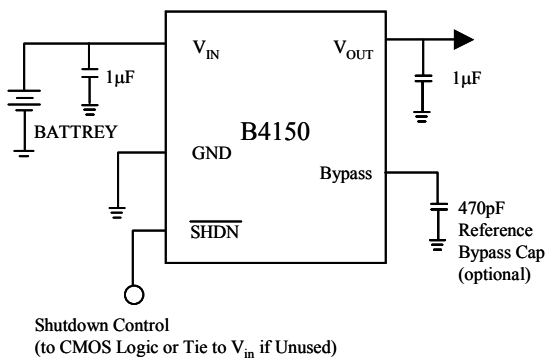

Ordering Information

-40°C to +125°C	
Package	Part No.
SOT-25	B4150CK5 -X.X
X.X = Fixed Output Voltages from 2.0V to 6.0V	

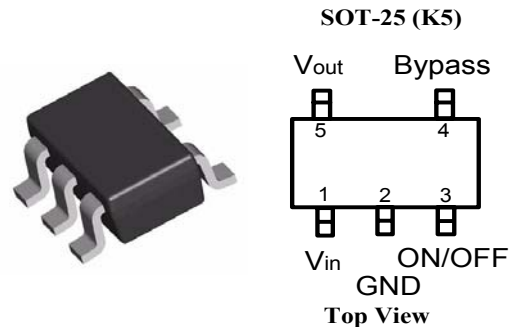

Absolute Maximum Ratings

Parameter	Symbol	Ratings	Units
Input Voltage	V_{IN}	6.5	V
Output Current	I_{OUT}	150	mA
CE Output Voltage	V_{OUT}	$V_{SS} - 0.3$ to $V_{IN} 0.3$	V
Continual Total Power Dissipation	Pd	150	mW
		300	
Operating Ambient Temperature	T_{OPR}	-30 to 80	°C
Storage Temperature	T_{STG}	-40 to 125	°C

Electrical Characteristics ($T_a = 25^\circ\text{C}$, $V_{IN} = V_{OUT} + 0.5\text{V}$; unless otherwise noted)

Parameter	Conditions	MIN	TYP	MAX	UNIT
Output Voltage Accuracy	$I_O = 1\text{mA}$	-1.4%	-	+1.4%	V
	$I_O = 0$ to 150mA	-2%	-	+2%	
Line Regulation	$\Delta V_{OUT}/\Delta V_{IN} - V_{OUT}$ $I_O = 100\text{mA}$, $(V_{OUT} + 0.1\text{V}) < V_{IN} < 6\text{V}$		0.2	0.3	%/V
Load Regulation	$V_{IN} 6\text{V}$, $0\text{mA} < I_O < 120\text{mA}$ $C_{OUT} = 1\mu\text{F}$		0.01	0.04	%/mV
Maximum Output Current		150			mA
Current Limit		160	500		
Output Noise (en)	$f=300\text{Hz}\sim 100\text{kHz}$, $C_{out}=1\mu\text{F}$, $I=10\text{mA}$, $C_{in}=1\mu\text{F}$		30		$\mu\text{V(rms)}$
Ripple Rejection Rate (PSSR)	$I_{out}=50\text{mA}$, $f=10\text{kHz}$		70		dB
Shutdown Supply Current	$T_A=25^\circ\text{C}$		0.01	1	μA
Shutdown Input Bias Current	$V_{SHDN}=V_{IN}$, $T_A=25^\circ\text{C}$		0.01	100	nA
Shutdown Exit Delay	$CBP=0\mu\text{F}$ $C_{OUT}=1\mu\text{F}$, $I_O = 1\text{mA}$		30	150	μsec
Shutdown Input Threshold Low	$V_{in}=2.5$ to 5.5V		0.4		V
Shutdown Input Threshold High	$V_{in}=2.5$ to 5.5V	2			V
Ground Pin Current	$I_{OUT} = 0\text{mA} \dots 150\text{mA}$			2	μA
Dropout Voltage	$I_O = 100\text{mA}$		110	160	mV
	$I_O = 150\text{mA}$		165	250	
Thermal Shutdown Temperature			155		°C

Marking Format

SOT-25

EXWW

E = B4150

Variables

X = Voltage Codes **WW = Work Week Code**

B = 2.0 F = 3.3 SOT-25 = 01 to 99

C = 2.5 G = 3.5

D = 2.8 H = 5.0

E = 3.0

PRODUCT DESCRIPTION

The B4150 is precision fixed output voltage regulator. Unlike bipolar regulators, the B4150 supply current does not increase with load current. In addition, V_{out} remains stable and within regulator at very low load currents (an important consideration in RTC and CMOS RAM battery back-up application).

Figure 1 shows a typical application circuit. The regulator is enabled any time the shutdown input is at or above V_{IH} . And shutdown (disabled) when SHDN is at or below V_{IL} . SHDN maybe controlled by a CMOS logic gate, or I/O port of a micro controller. If the SHDN input is not. Required, it should be connected directly to the supply. While in shutdown, supply current decreases to 0.05 μ A (typical) and V_{out} falls to zero volts.

Bypass Input

A 470pF capacitor connected from the bypass input to ground reduces noise present on the internal reference, which in turn significantly reduces output noise. If output noise is not a concern, this input maybe left unconnected. Larger capacitor values maybe used, but it results in a longer time period to rated output voltage power is initially applied.

Output Capacitor

A 1 μ F (min) capacitor from V_{out} to ground is required. Then output capacitor should have an effective series resistance of 5 Ω or less. A 1 μ A capacitor should be connected from V_{in} to GND if there is more than 10 inches of wire between the regulator and the AC filter capacitor, or if a battery is used as the power source. Aluminum electrolytic or tantalum capacitor types can be used. (since many aluminum electrolytic capacitors freeze at approximately- 30°C, solid tantalums are recommended for applications operating below -25 °C.) When operating from sources other than batteries, supply-noise rejection and transient response can be improved by increasing the value of the input and output capacitors and employing passive filtering techniques.

Thermal Considerations

Thermal Shutdown

Integrated thermal protection circuitry shuts the regulator off when die temperature exceeds 160°C. The regulator remaining off until the die temperature drops to approximately 150 °C.

Power Dissipation

The amount of power the regulator dissipates is primarily a function of input and output voltage, and output current. The following equation is used to calculate worst case power dissipation:

$$P_D = (V_{INMAX} - V_{OUTMIN}) I_{LOADMAX}$$

Where:

P_D = worst case actual power dissipation

V_{INMAX} = Maximum voltage on V_{IN}

V_{OUTMIN} = Minimum regulator output voltage

$I_{LOADMAX}$ = maximum output (LOAD) Current

The maximum allowable power dissipation is function of the maximum ambient temperature (T_{AMAX}). The maximum allowable die temperature (125°C) and the thermal resistance from junction-to-air (θ_{JA}). The 5-pin SOT-23A package has a θ_{JA} of approximately 220°C/Watt when mounted on a single layer FR4 dielectric copper clad PC board.

$$P_{DMAX} = (T_{JMAX} - T_{AMAX}) / \theta_{JA}$$

Where all terms are previously defined

This can be caused in conjunction with other equation to ensure regulator thermal operation is within limit. For example:

Given:

$$V_{INMAX} = 3.0V + 10\%$$

$$V_{OUTMIN} = 2.7V - 2.5\%$$

$$I_{LOADMAX} = 40 \text{ mA}$$

$$T_{JMAX} = 125^\circ\text{C}$$

$$T_{AMAX} = 55^\circ\text{C}$$

Find:

1. Actual power dissipation
2. Maximum allowable dissipation

Actual power dissipation:

$$\begin{aligned} P_D &= (V_{INMAX} - V_{OUTMIN}) I_{LOADMAX} \\ &= [(3.0 \times 1.1) - (2.7 \times 0.975)] 40 \times 10^{-3} \\ &= 26.7 \text{ mW} \end{aligned}$$

Maximum allowable power dissipation:

$$\begin{aligned} P_{DMAX} &= (T_{JMAX} - T_{AMAX}) \\ &= (125 - 55) / 220 \\ &= 318 \text{ mW} \end{aligned}$$

These equations can be used to calculate maximum current and/or input voltage limits.

TEST CIRCUITS

Circuit 1

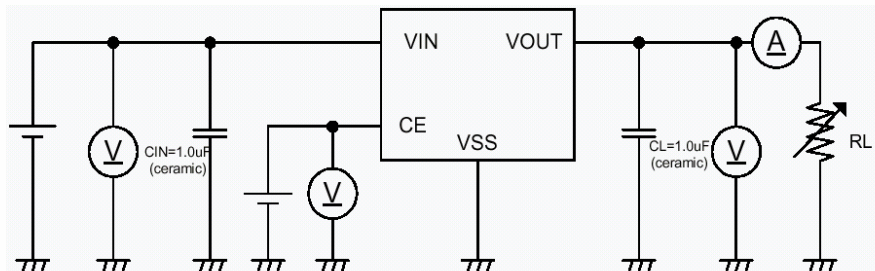

Circuit 2

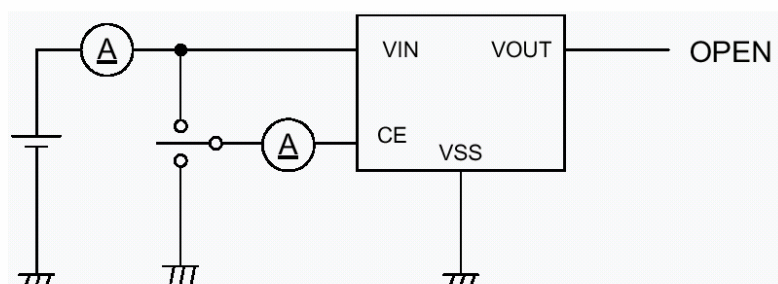

Circuit 3

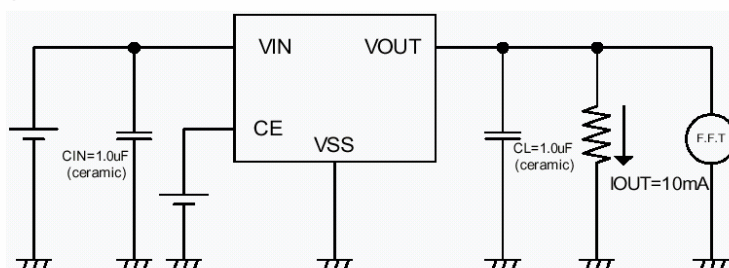

Circuit 4

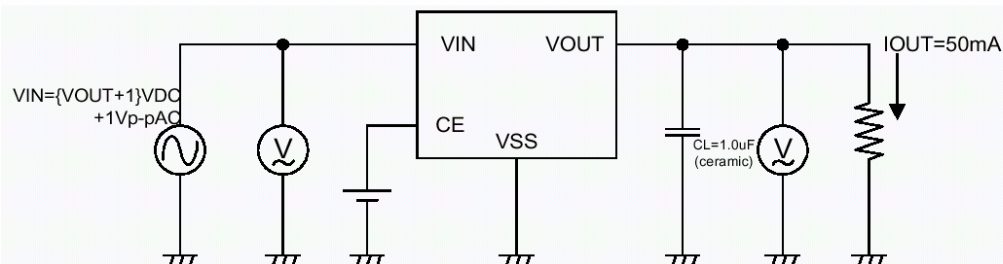

Output Voltage VS. Output current

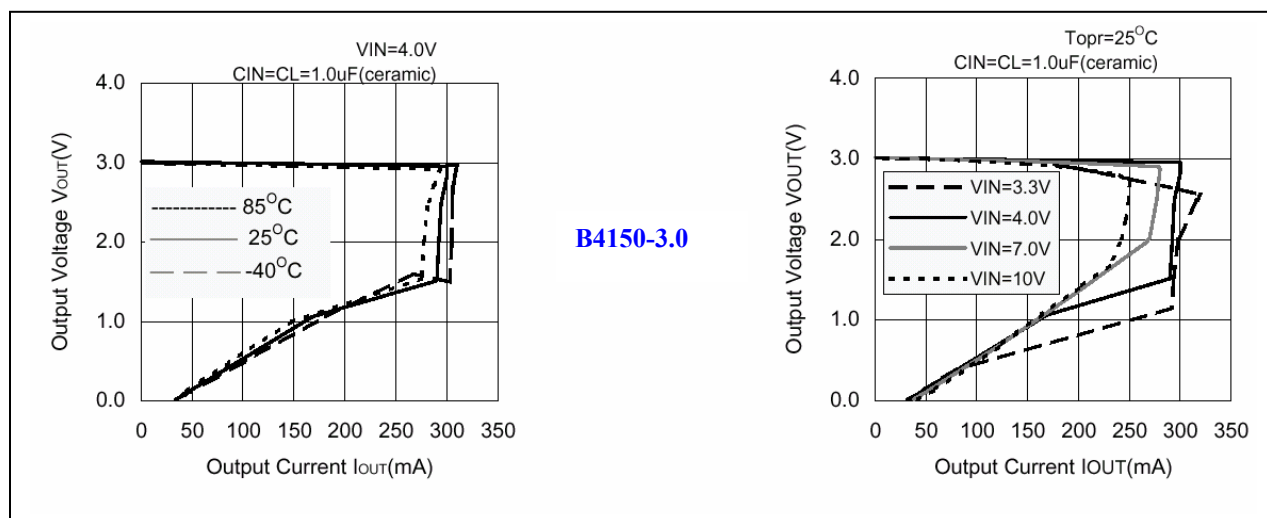
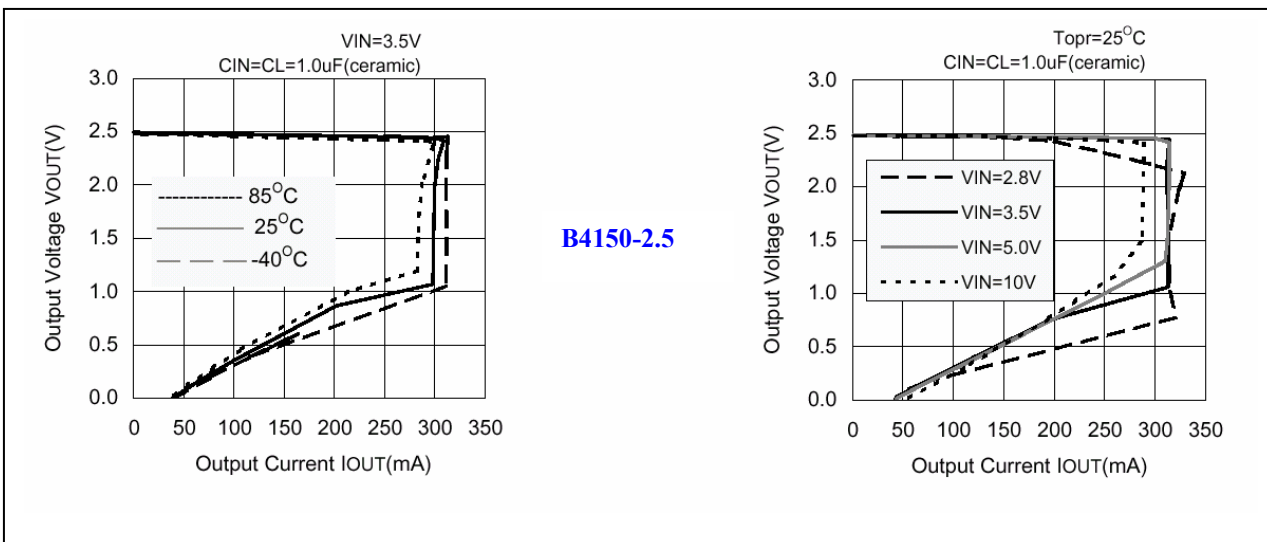

Output Voltage vs. Input Voltage

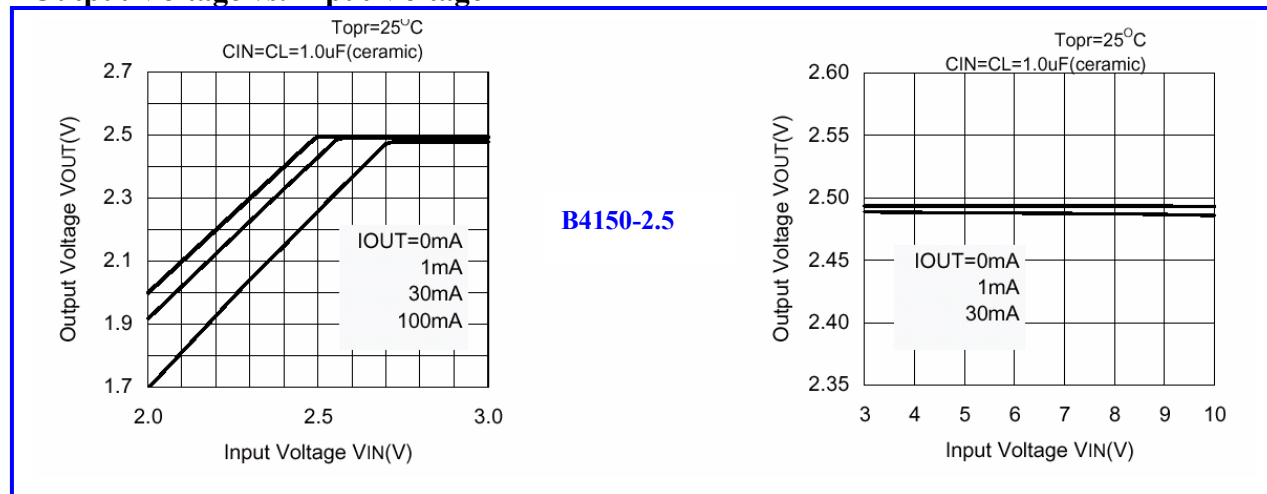

Dropout Voltage vs. Output Current

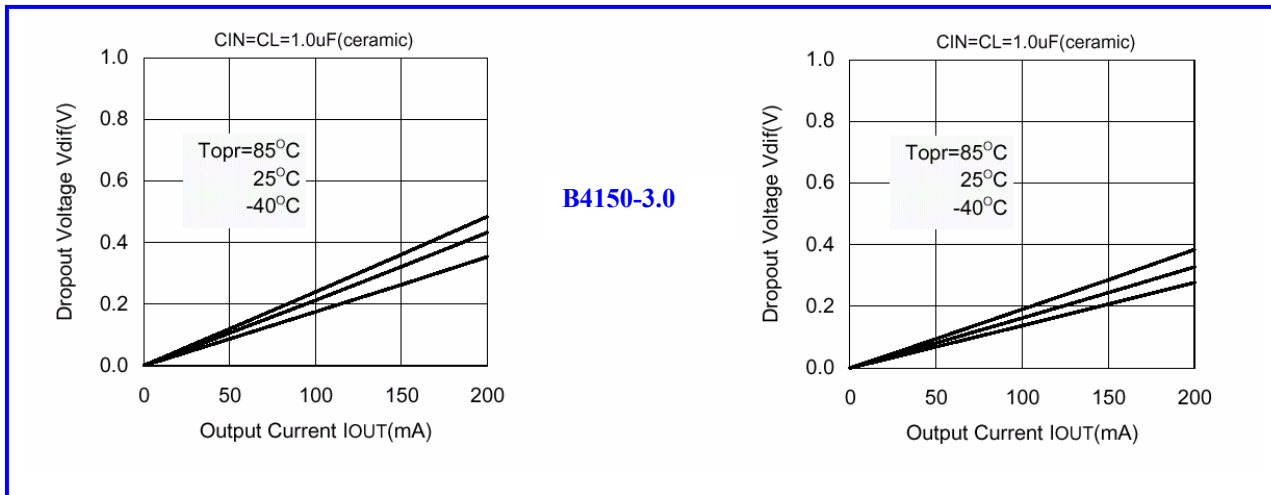

Input Transient Response

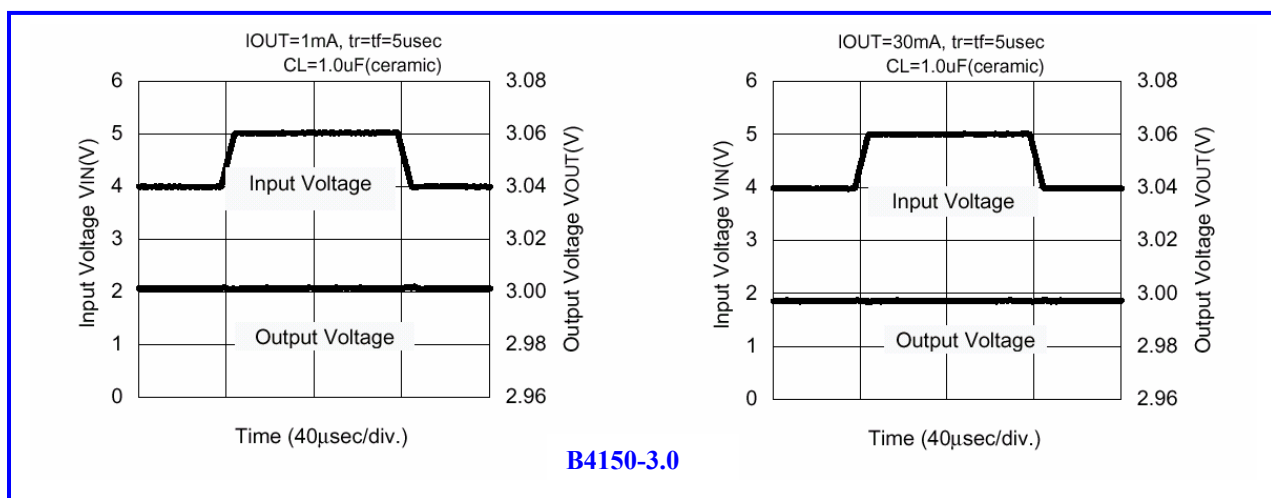
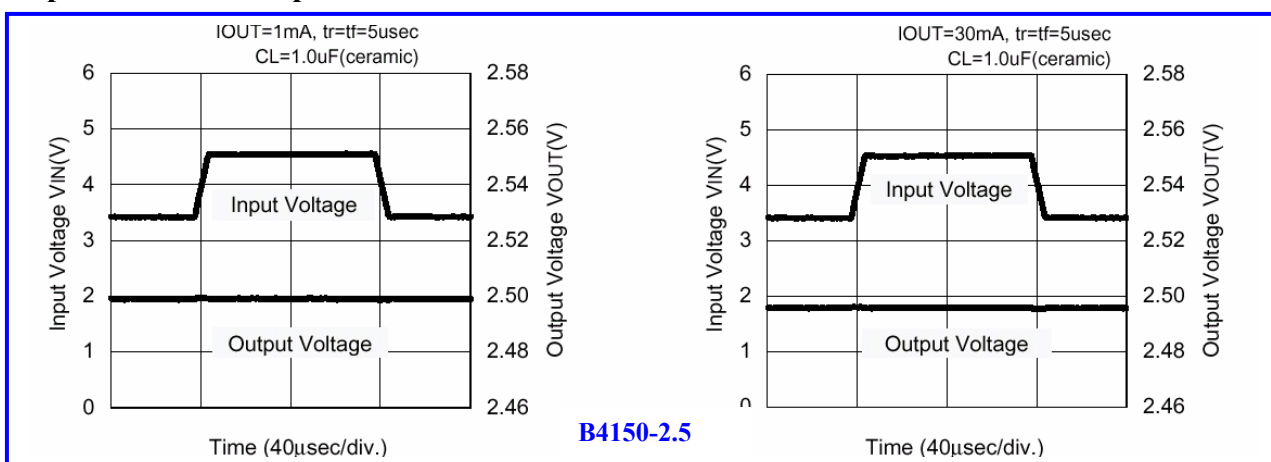

Load Transients Response

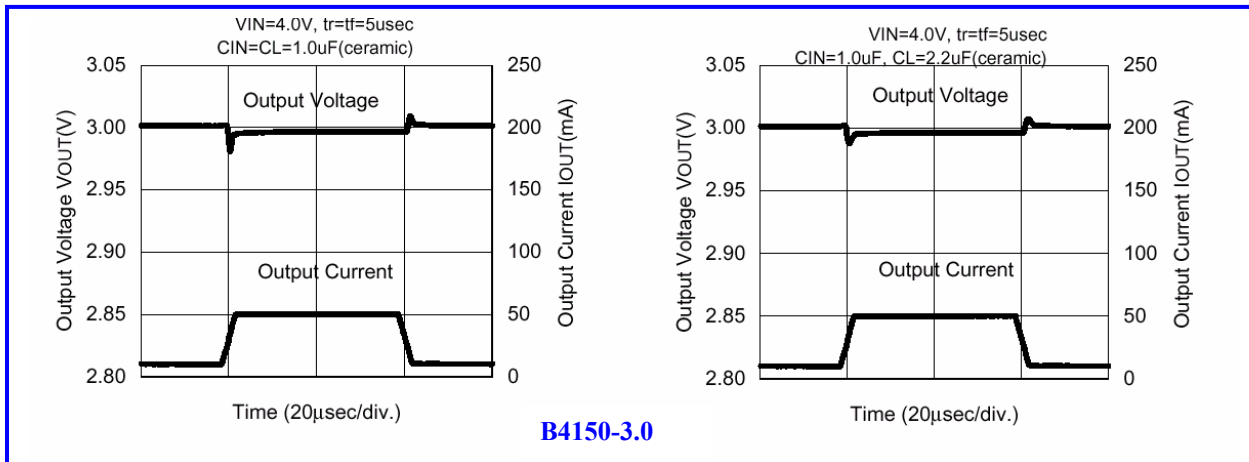

Turn On Response Time

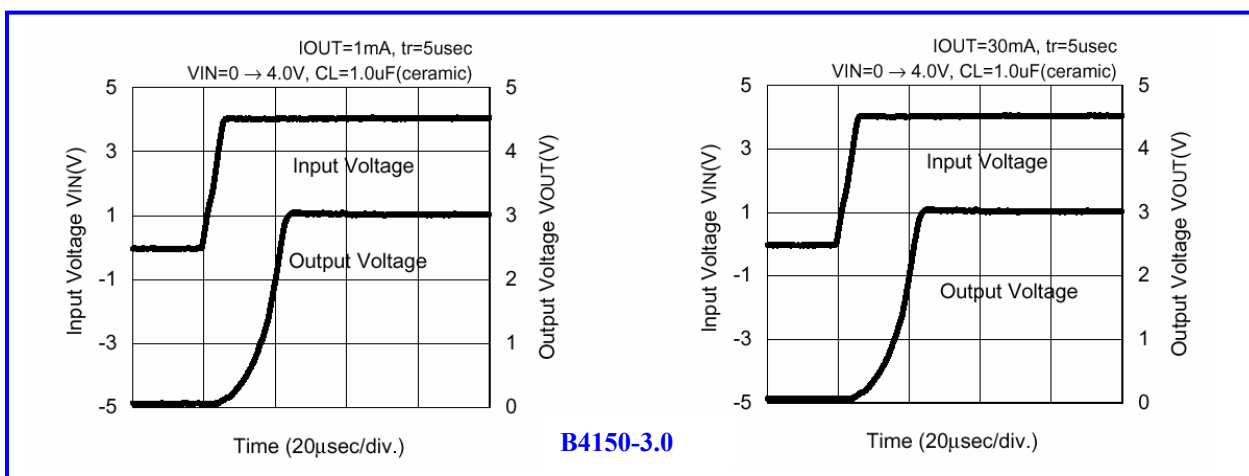

Ripple Rejection

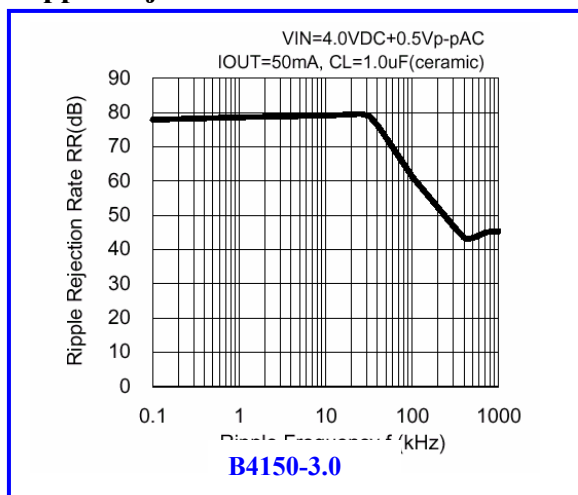

Output Noise

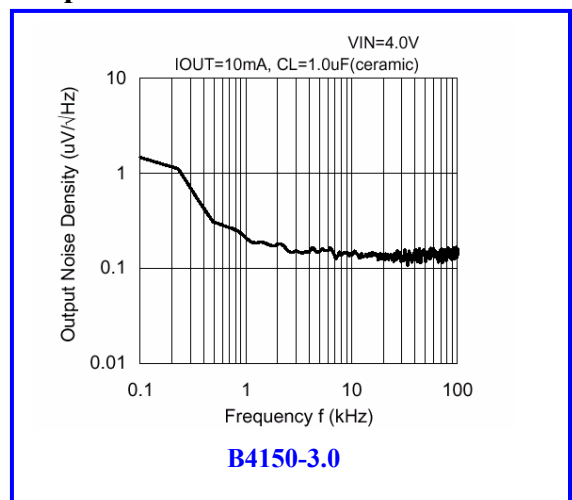

SOT-25 Packaging Outline

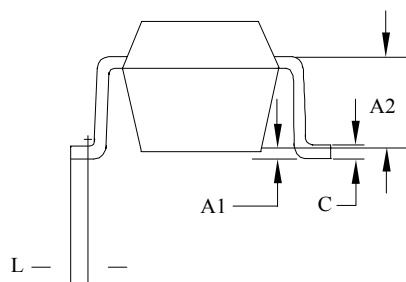
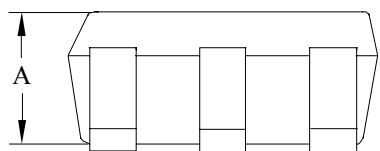
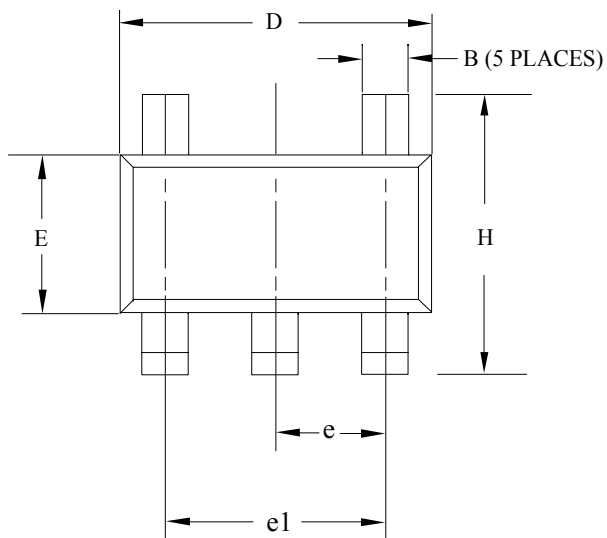

SYMBOL	MILLIMETERS		INCHES	
	MIN.	MAX.	MIN.	MAX.
A	0.90	1.30	.035	.051
A1	0	0.10	0	.004
A2	0.80 REF		.0315 REF	
B	0.30	0.50	.012	.019
C	0.10	0.35	.004	.0137
D	2.70	3.10	.106	.122
E	1.40	1.80	.055	.071
e	0.95 BSC.		.037 BSC.	
e1	1.70	2.10	.066	.082
H	2.50	3.00	.098	.118
L	MIN 0.2		MIN .0078	

NOTE:

1. REFER TO APPLICABLE
2. CONTROLLING DIMENTION : MILLIMETER
3. PACKAGE SURFACE FINISHING TO BE SMOOTH FINISH.

Advance Information- These data sheets contain descriptions of products that are in development. The specifications are based on the engineering calculations, computer simulations and/ or initial prototype evaluation.

Preliminary Information- These data sheets contain minimum and maximum specifications that are based on the initial device characterizations. These limits are subject to change upon the completion of the full characterization over the specified temperature and supply voltage ranges.

The application circuit examples are only to explain the representative applications of the devices and are not intended to guarantee any circuit design or permit any industrial property right to other rights to execute. Bay Linear takes no responsibility for any problems related to any industrial property right resulting from the use of the contents shown in the data book. Typical parameters can and do vary in different applications. Customer's technical experts must validate all operating parameters including "Typical" for each customer application.

LIFE SUPPORT AND NUCLEAR POLICY

Bay Linear products are not authorized for and should not be used within life support systems which are intended for surgical implants into the body to support or sustain life, in aircraft, space equipment, submarine, or nuclear facility applications without the specific written consent of Bay Linear President.
