

High Performance

1M×4

CMOS DRAM



AS4C14400

AS4C14405

1M-bit × 4 CMOS DRAM (Fast page mode or EDO)

Preliminary information

Features

- Organization: 1,048,576 words × 4 bits
- High speed
 - 40/50/60/70 ns $\overline{\text{RAS}}$ access time
 - 20/25/30/35 ns column address access time
 - 10/13/15/18 ns $\overline{\text{CAS}}$ access time
- Low power consumption
 - Active: 385 mW max (-60)
 - Standby: 5.5 mW max, CMOS I/O
- Fast page mode (AS4C14400) or EDO (AS4C14405)
- 1024 refresh cycles, 16 ms refresh interval
 - $\overline{\text{RAS}}$ -only or $\overline{\text{CAS}}$ -before- $\overline{\text{RAS}}$ refresh
- Read-modify-write
- TTL-compatible, three-state I/O
- JEDEC standard packages
 - 300 mil, 20/26-pin SOJ
 - 300 mil, 20/26-pin TSOP
- Single 5V power supply
- ESD protection ≥ 2001V
- Latch-up current ≥ 200 mA

Pin arrangement

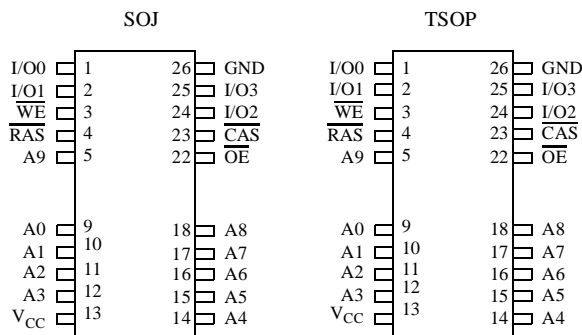

Pin designation

Pin(s)	Description
A0 to A9	Address inputs
$\overline{\text{RAS}}$	Row address strobe
I/O0 to I/O3	Input/output
$\overline{\text{OE}}$	Output enable
$\overline{\text{CAS}}$	Column address strobe
$\overline{\text{WE}}$	Read/write control
V _{CC}	Power (5.0 ± 0.5V)
GND	Ground

Selection guide

	Symbol	4C14400-40	4C14400-50	4C14400-60	4C14400-70	Unit
Maximum $\overline{\text{RAS}}$ access time	t _{RAC}	40	50	60	70	ns
Maximum column address access time	t _{CAA}	20	25	30	35	ns
Maximum $\overline{\text{CAS}}$ access time	t _{CAC}	10	13	15	18	ns
Maximum output enable ($\overline{\text{OE}}$) access time	t _{OEA}	10	13	15	18	ns
Minimum read or write cycle time	t _{RC}	70	90	110	130	ns
Minimum fast page mode cycle time	t _{PC}	30	35	40	45	ns
Maximum operating current	I _{CC1}	90	80	70	60	mA
Maximum CMOS standby current	I _{CC5}	1.0	1.0	1.0	1.0	mA

Shaded areas contain advance information.

ALLIANCE SEMICONDUCTOR



Absolute maximum ratings

Parameter	Symbol	Minimum	Maximum	Unit
Input voltage	V_{in}	-1.0	+7.0	V
Output voltage	V_{out}	-1.0	+7.0	V
Power supply voltage	V_{CC}	-1.0	+7.0	V
Storage temperature (plastic)	T_{STG}	-55	+150	°C
Soldering temperature × time	T_{SOLDER}	–	260×10	°C × sec
Power dissipation	P_D	–	1	W
DC output current	I_{out}	–	50	mA

NOTE: Stresses greater than those listed under Absolute Maximum Ratings may cause permanent damage to the device. This is a stress rating only and functional operation of the device at these or any other conditions outside those indicated in the operational sections of this specification is not implied. Exposure to absolute maximum rating conditions for extended periods may affect reliability.

DC electrical characteristics

Parameter	Symbol	Test Conditions	-40		-50		-60		-70		Unit	Notes
			Min	Max	Min	Max	Min	Max	Min	Max		
Input leakage current	I_I	$0V \leq V_{in} \leq +5.5V$ Pins not under test = 0V	-2	+2	-2	+2	-2	+2	-2	+2	μA	
Output leakage current	I_{OZ}	Outputs disabled, $0V \leq V_{out} \leq +5.5V$	-10	+10	-10	+10	-10	+10	-10	+10	μA	
Operating power supply current	I_{CC1}	\overline{RAS} , \overline{CAS} , Address cycling: $t_{RC} = \min$	–	90	–	80	–	70	–	60	mA	1,2
TTL standby power supply current	I_{CC2}	$\overline{RAS} = \overline{CAS} = V_{IH}$	–	2.0	–	2.0	–	2.0	–	2.0	mA	
Average power supply current, RAS refresh mode	I_{CC3}	\overline{RAS} cycling, $\overline{CAS} = V_{IH}$, $t_{RC} = \min$	–	90	–	80	–	70	–	60	mA	1
Fast page mode average power supply current	I_{CC4}	$\overline{RAS} = V_{IL}$, \overline{CAS} cycling, Address cycling: $t_{PC} = \min$	–	80	–	70	–	60	–	50	mA	1,2
CMOS standby power supply current	I_{CC5}	$\overline{RAS} = \overline{CAS} = V_{CC} - 0.2V$	–	1.0	–	1.0	–	1.0	–	1.0	mA	
\overline{CAS} -before- \overline{RAS} refresh power supply current	I_{CC6}	\overline{RAS} , \overline{CAS} cycling: $t_{RC} = \min$	–	90	–	80	–	70	–	60	mA	1
Output voltage	V_{OH}	$I_{OUT} = -5.0 \text{ mA}$	2.4	–	2.4	–	2.4	–	2.4	–	V	
	V_{OL}	$I_{OUT} = 4.2 \text{ mA}$	–	0.4	–	0.4	–	0.4	–	0.4	V	

Shaded areas contain advance information.



AC parameters common to all waveforms

Symbol	Parameter	-40		-50		-60		-70		Unit	Notes
		Min	Max	Min	Max	Min	Max	Min	Max		
t_{RC}	Random read or write cycle time	70	–	90	–	110	–	130	–	ns	
t_{RP}	\overline{RAS} precharge time	20	–	30	–	40	–	50	–	ns	
t_{RAS}	\overline{RAS} pulse width	40	10K	50	10K	60	10K	70	10K	ns	
t_{CAS}	\overline{CAS} pulse width	10	–	13	–	15	–	18	–	ns	
t_{RCD}	\overline{RAS} to \overline{CAS} delay time	18	30	20	37	20	45	20	52	ns	6
t_{RAD}	\overline{RAS} to column address delay time	13	20	15	25	15	30	15	35	ns	7
$t_{RSH(R)}$	\overline{CAS} to \overline{RAS} hold time (read)	10	–	13	–	15	–	18	–	ns	
t_{CSH}	\overline{RAS} to \overline{CAS} hold time	40	–	50	–	60	–	70	–	ns	
t_{CRP}	\overline{CAS} to \overline{RAS} precharge time	0	–	0	–	0	–	0	–	ns	
t_{ASR}	Row address setup time	0	–	0	–	0	–	0	–	ns	
t_{RAH}	Row address hold time	8	–	10	–	10	–	10	–	ns	
t_T	Transition time (rise and fall)	2	50	2	50	2	50	2	50	ns	4,5
t_{REF}	Refresh period	–	16	–	16	–	16	–	16	ms	3
t_{CLZ}	\overline{CAS} to output in low Z	0	–	0	–	0	–	0	–	ns	8

Shaded areas contain advance information.

Read cycle

Symbol	Parameter	-40		-50		-60		-70		Unit	Notes
		Min	Max	Min	Max	Min	Max	Min	Max		
t_{RAC}	Access time from \overline{RAS}	–	40	–	50	–	60	–	70	ns	6
t_{CAC}	Access time from \overline{CAS}	–	10	–	13	–	15	–	18	ns	6,13
t_{AA}	Access time from address	–	20	–	25	–	30	–	35	ns	7,13
$t_{AR(R)}$	Column add hold from \overline{RAS}	30	–	40	–	45	–	55	–	ns	
t_{RCS}	Read command setup time	0	–	0	–	0	–	0	–	ns	
t_{RCH}	Read command hold time to \overline{CAS}	0	–	0	–	0	–	0	–	ns	9
t_{RRH}	Read command hold time to \overline{RAS}	0	–	0	–	0	–	0	–	ns	9
t_{RAL}	Column address to \overline{RAS} lead time	20	–	25	–	30	–	35	–	ns	
t_{CPN}	\overline{CAS} precharge time	5	–	10	–	10	–	10	–	ns	
t_{ODS}	Output disable setup time	0	–	0	–	0	–	0	–	ns	
t_{OFF}	Output buffer turn-off time	0	10	0	13	0	15	0	18	ns	8,10

Shaded areas contain advance information.



Write cycle

Symbol	Parameter	-40		-50		-60		-70		Unit	Notes
		Min	Max	Min	Max	Min	Max	Min	Max		
t _{ASC}	Column address setup time	0	–	0	–	0	–	0	–	ns	
t _{CAH}	Column address hold time	8	–	10	–	10	–	15	–	ns	
t _{AWR}	Column address hold time to $\overline{\text{RAS}}$	30	–	40	–	45	–	55	–	ns	
t _{WCS}	Write command setup time	0	–	0	–	0	–	0	–	ns	11
t _{WCH}	Write command hold time	5	–	10	–	10	–	15	–	ns	11
t _{WCR}	Write command hold time to $\overline{\text{RAS}}$	30	–	40	–	45	–	55	–	ns	
t _{WCP}	Write command pulse width	8	–	10	–	10	–	15	–	ns	
t _{RWL}	Write command to $\overline{\text{RAS}}$ lead time	10	–	13	–	15	–	18	–	ns	
t _{CWL}	Write command to $\overline{\text{CAS}}$ lead time	10	–	13	–	15	–	18	–	ns	
t _{DS}	Data-In setup time	0	–	0	–	0	–	0	–	ns	12
t _{DH}	Data-In hold time	8	–	10	–	10	–	15	–	ns	12
t _{DHR}	Data-In hold time to $\overline{\text{RAS}}$	30	–	40	–	45	–	55	–	ns	

Shaded areas contain advance information.

Read-modify-write cycle

Symbol	Parameter	-40		-50		-60		-70		Unit	Notes
		Min	Max	Min	Max	Min	Max	Min	Max		
t _{RWC}	Read-write cycle time	105	–	131	–	155	–	181	–	ns	
t _{RWD}	$\overline{\text{RAS}}$ to $\overline{\text{WE}}$ delay time	60	–	73	–	85	–	98	–	ns	11
t _{CWD}	$\overline{\text{CAS}}$ to $\overline{\text{WE}}$ delay time	30	–	36	–	40	–	46	–	ns	11
t _{AWD}	Column address to $\overline{\text{WE}}$ delay time	40	–	48	–	55	–	63	–	ns	11
t _{RSH(W)}	$\overline{\text{CAS}}$ to $\overline{\text{RAS}}$ hold time (write)	10	–	13	–	15	–	18	–	ns	
t _{CAS(W)}	$\overline{\text{CAS}}$ pulse width (write)	10	–	13	–	15	–	18	–	ns	

Shaded areas contain advance information.



Fast page mode cycle

Symbol	Parameter	-40		-50		-60		-70		Unit	Notes
		Min	Max	Min	Max	Min	Max	Min	Max		
t_{PC}	Read-write cycle time (fast page)	30	–	35	–	40	–	45	–	ns	14
t_{CAP}	Access time from \overline{CAS} precharge	–	25	–	30	–	35	–	40	ns	13
t_{CP}	\overline{CAS} precharge time (fast page)	5	–	10	–	10	–	10	–	ns	
t_{PCM}	Fast page mode RMW cycle	65	–	76	–	85	–	96	–	ns	
t_{CRW}	Page mode \overline{CAS} pulse width (RMW)	45	–	54	–	60	–	69	–	ns	
t_{RASP}	\overline{RAS} pulse width	40	100K	50	100K	60	100K	70	100K	ns	

Shaded areas contain advance information.

Refresh cycle

Symbol	Parameter	-40		-50		-60		-70		Unit	Notes
		Min	Max	Min	Max	Min	Max	Min	Max		
t_{CSR}	\overline{CAS} setup time (\overline{CAS} -before- \overline{RAS})	10	–	10	–	10	–	10	–	ns	3
t_{CHR}	\overline{CAS} hold time (\overline{CAS} -before- \overline{RAS})	10	–	10	–	15	–	15	–	ns	3
t_{RPC}	\overline{RAS} precharge to \overline{CAS} hold time	0	–	0	–	0	–	0	–	ns	
t_{CPT}	\overline{CAS} precharge time (\overline{CAS} -before- \overline{RAS} counter test)	5	–	10	–	10	–	10	–	ns	

Shaded areas contain advance information.

Output enable

Std Symbol	Parameter	-40		-50		-60		-70		Unit	Notes
		Min	Max	Min	Max	Min	Max	Min	Max		
t_{ROH}	\overline{RAS} hold time referenced to \overline{OE}	5	–	10	–	10	–	10	–	ns	
t_{OEA}	\overline{OE} access time	–	10	–	13	–	15	–	18	ns	
t_{OED}	\overline{OE} to data delay	10	–	13	–	15	–	18	–	ns	
t_{OEZ}	Output buffer turnoff delay from \overline{OE}	–	10	–	13	–	15	–	18	ns	8, 10
t_{OEH}	\overline{OE} command hold time	10	–	13	–	15	–	18	–	ns	

Shaded areas contain advance information.



Notes

- 1 I_{CC1} , I_{CC3} , I_{CC4} , and I_{CC6} depend on cycle rate.
- 2 I_{CC1} and I_{CC4} depend on output loading. Specified values are obtained with the output open.
- 3 An initial pause of 200 μ s is required after power-up followed by any 8 $\overline{\text{RAS}}$ cycles before proper device operation is achieved. In the case of an internal refresh counter, a minimum of 8 $\overline{\text{CAS}}$ -before- $\overline{\text{RAS}}$ initialization cycles instead of 8 $\overline{\text{RAS}}$ cycles are required. 8 initialization cycles are required after extended periods of bias without clocks (greater than 16 ms).
- 4 AC Characteristics assume $t_T = 5$ ns. All AC parameters are measured with a load equivalent to two TTL loads and 100 pF, $V_{IL}(\text{min}) \geq \text{GND}$ and $V_{IH}(\text{max}) \leq V_{CC}$. See AC test conditions for more information.
- 5 $V_{IH}(\text{min})$ and $V_{IL}(\text{max})$ are reference levels for measuring timing of input signals. Transition times are measured between V_{IH} and V_{IL} .
- 6 Operation within the $t_{\text{RCD}}(\text{max})$ limit ensures that $t_{\text{RAC}}(\text{max})$ can be met. $t_{\text{RCD}}(\text{max})$ is specified as a reference point only. If t_{RCD} is greater than the specified $t_{\text{RCD}}(\text{max})$ limit, then access time is controlled exclusively by t_{CAC} .
- 7 Operation within the $t_{\text{RAD}}(\text{max})$ limit ensures that $t_{\text{RAC}}(\text{max})$ can be met. $t_{\text{RAD}}(\text{max})$ is specified as a reference point only. If t_{RAD} is greater than the specified $t_{\text{RAD}}(\text{max})$ limit, then access time is controlled exclusively by t_{AA} .
- 8 Assumes three state test load (5 pF and a 380 Ω Thevenin equivalent).
- 9 Either t_{RCH} or t_{RRH} must be satisfied for a read cycle.
- 10 $t_{\text{OFF}}(\text{max})$ defines the time at which the output achieves the open circuit condition; it is not referenced to output voltage levels.
- 11 t_{WCS} , t_{WCH} , t_{RWD} , t_{CWD} and t_{AWD} are not restrictive operating parameters. They are included in the datasheet as electrical characteristics only. If $t_{\text{WCS}} \geq t_{\text{WCS}}(\text{min})$ and $t_{\text{WCH}} \geq t_{\text{WCH}}(\text{min})$, the cycle is an early write cycle and data out pins will remain open circuit, high impedance, throughout the cycle. If $t_{\text{RWD}} \geq t_{\text{RWD}}(\text{min})$, $t_{\text{CWD}} \geq t_{\text{CWD}}(\text{min})$ and $t_{\text{AWD}} \geq t_{\text{AWD}}(\text{min})$, the cycle is a read-write cycle and the data out will contain data read from the selected cell. If neither of the above conditions is satisfied, the condition of the data out at access time is indeterminate.
- 12 These parameters are referenced to $\overline{\text{CAS}}$ leading edge in early write cycles and to $\overline{\text{WE}}$ leading edge in read-write cycles.
- 13 Access time is determined by the longest of t_{CAA} or t_{CAC} or t_{CAP} .
- 14 $t_{\text{ASC}} \geq t_{\text{CP}}$ to achieve $t_{\text{PC}}(\text{min})$ and $t_{\text{CAP}}(\text{max})$ values.
- 15 These parameters are sampled and not 100% tested.

AC test conditions

- Access times are measured with output reference levels of $V_{\text{OH}} = 2\text{V}$ and $V_{\text{OL}} = 0.8\text{V}$
- Input rise and fall times: 5 ns

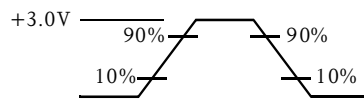
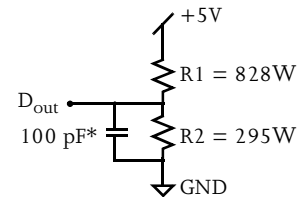

Figure A: Input waveform



*including scope and jig capacitance

Figure B: Equivalent output load

Key to switching waveforms





Timing waveform of read cycle

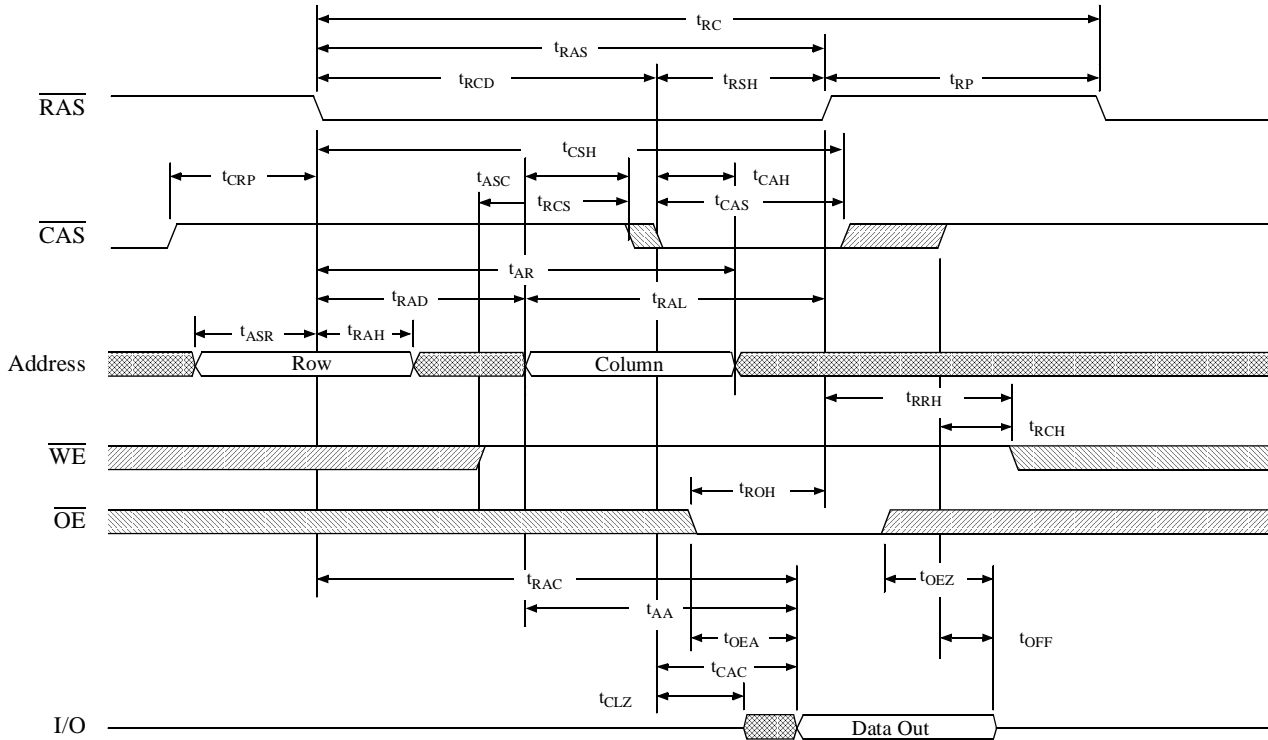

Timing waveform of early write cycle

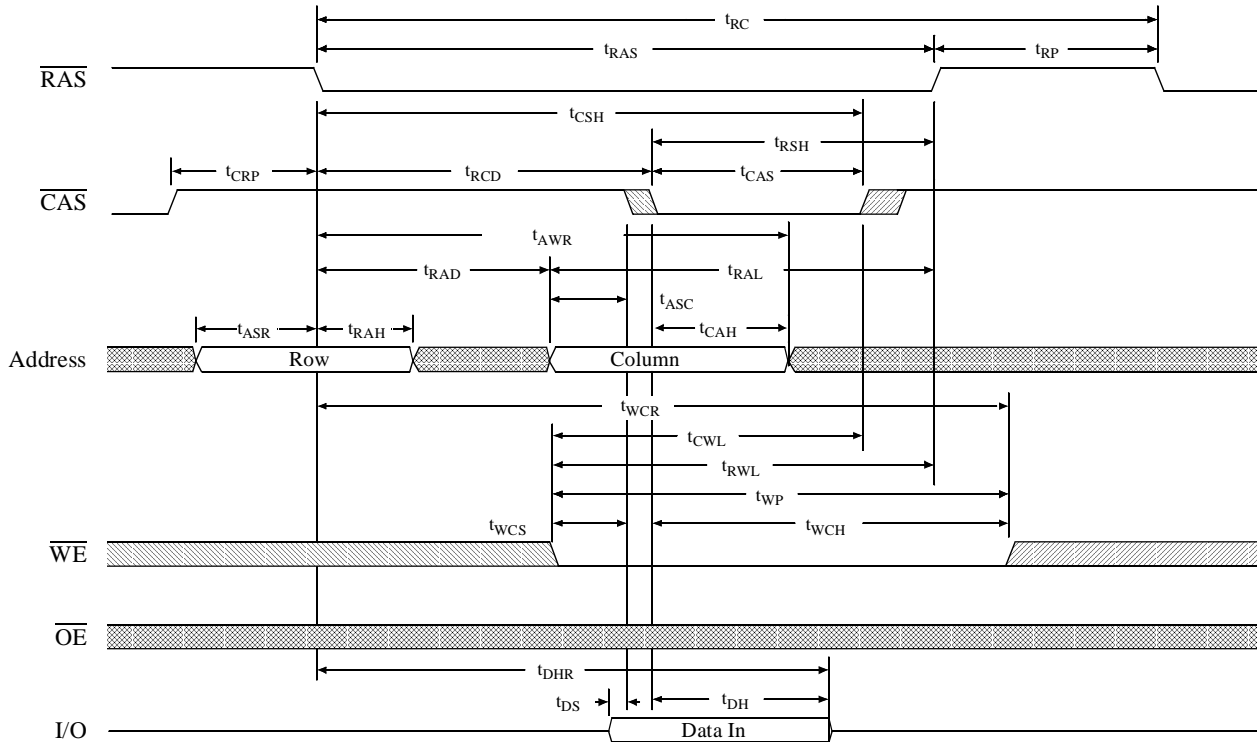

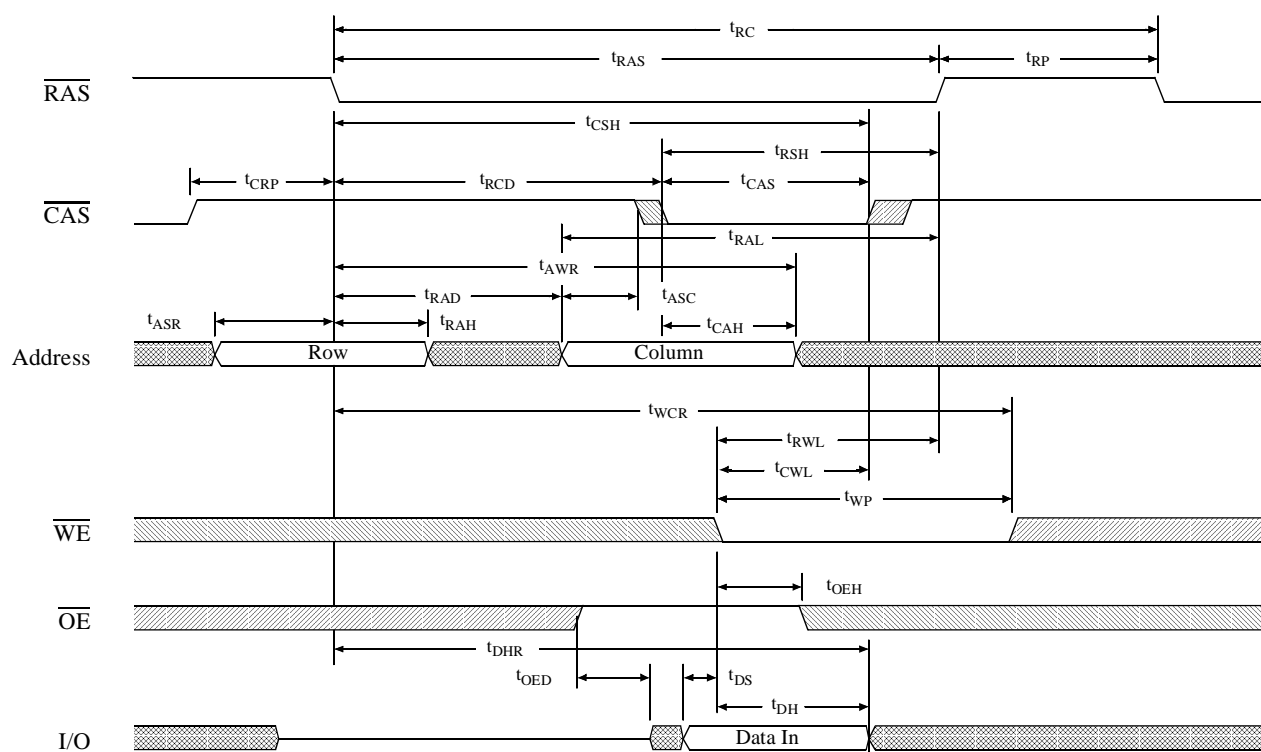

Timing waveform of write cycle

($\overline{\text{OE}}$ controlled)

Timing waveform of read-write cycle

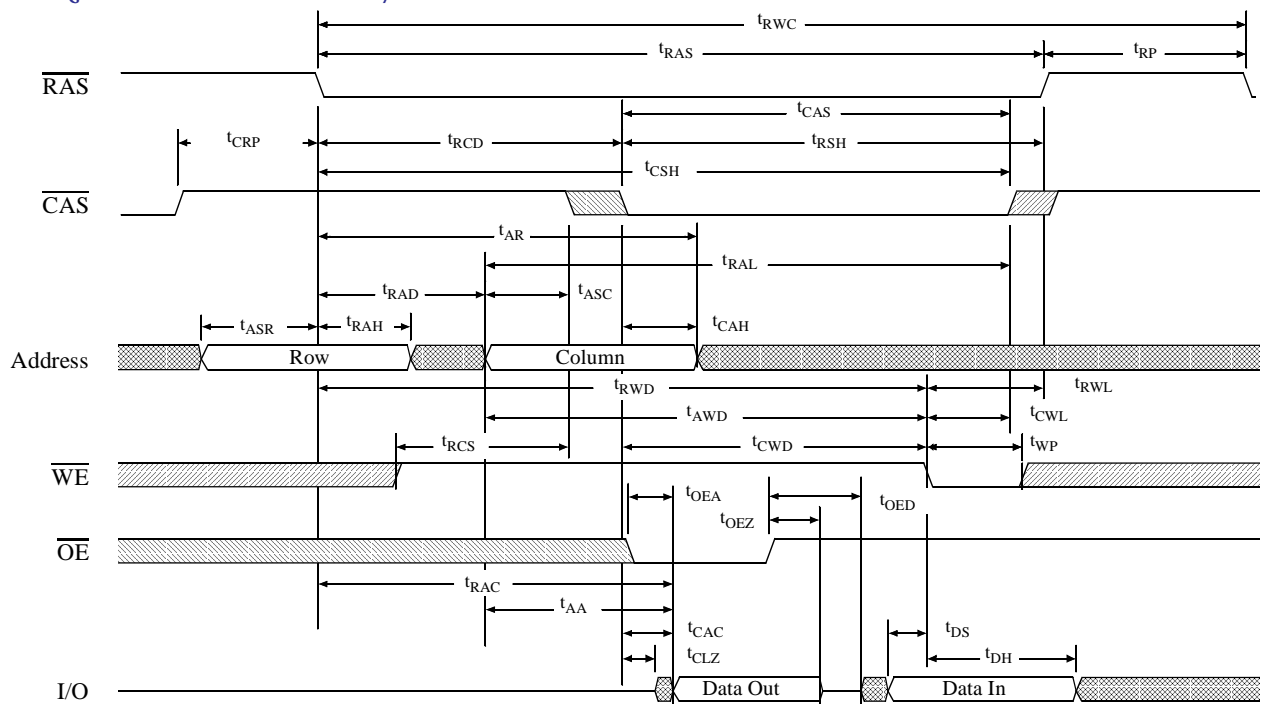



Timing waveform of fast page mode read cycle

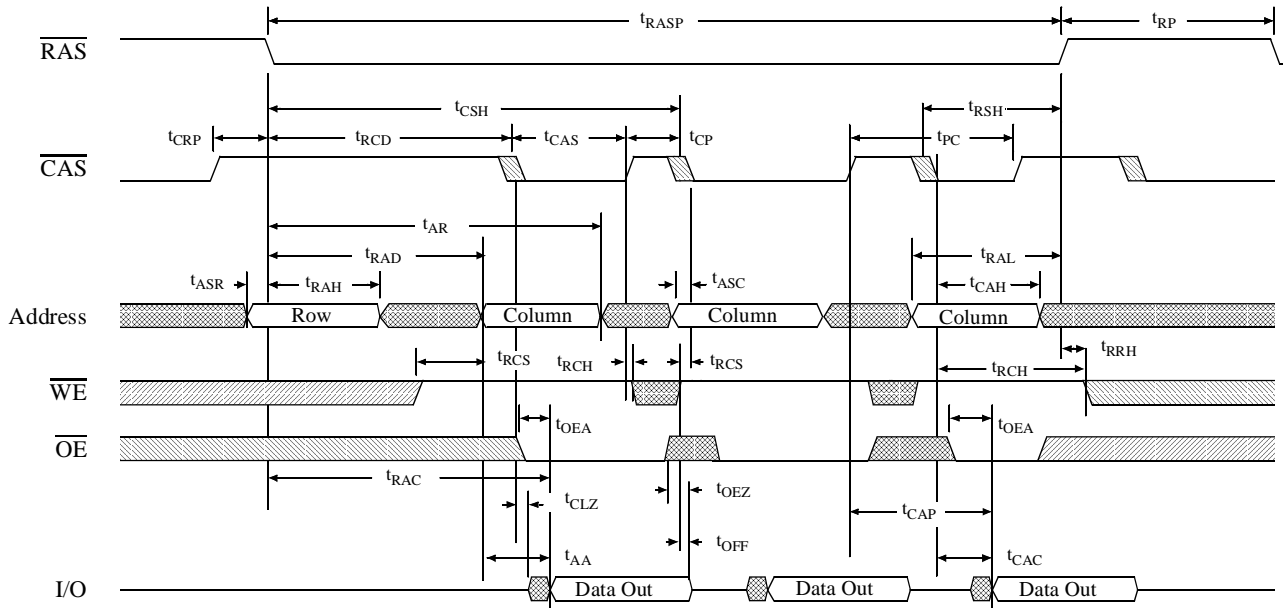

Timing waveform of fast page mode early write cycle

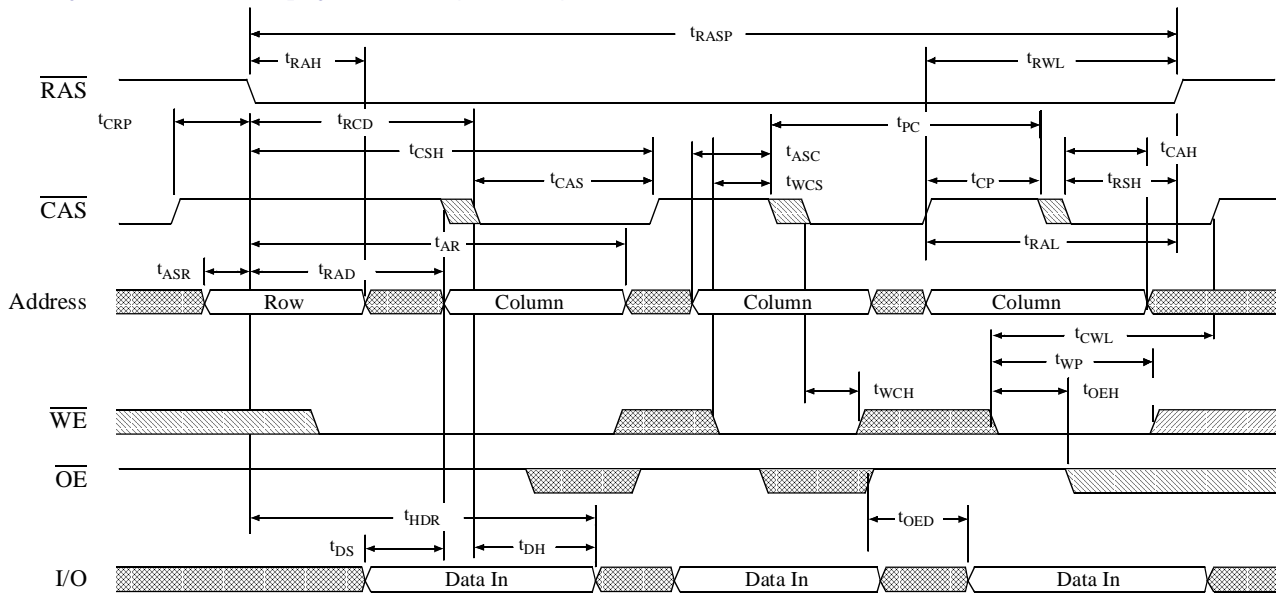



Timing waveform of hidden refresh cycle (read)

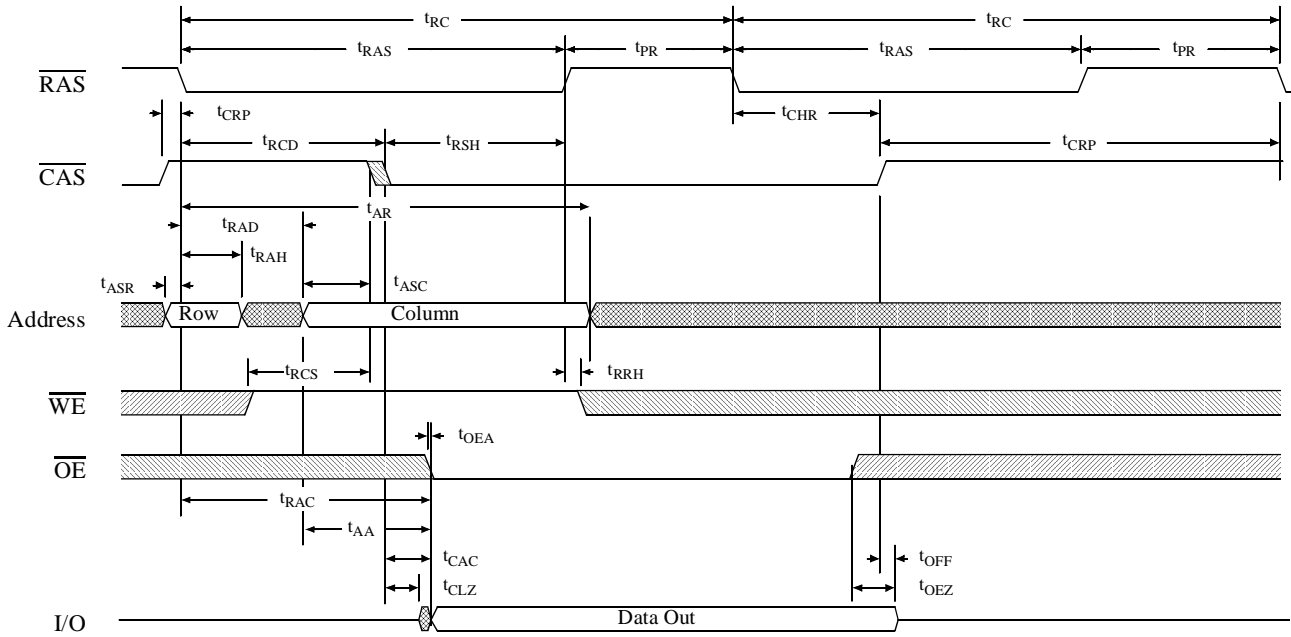

Timing waveform of hidden refresh cycle (write)

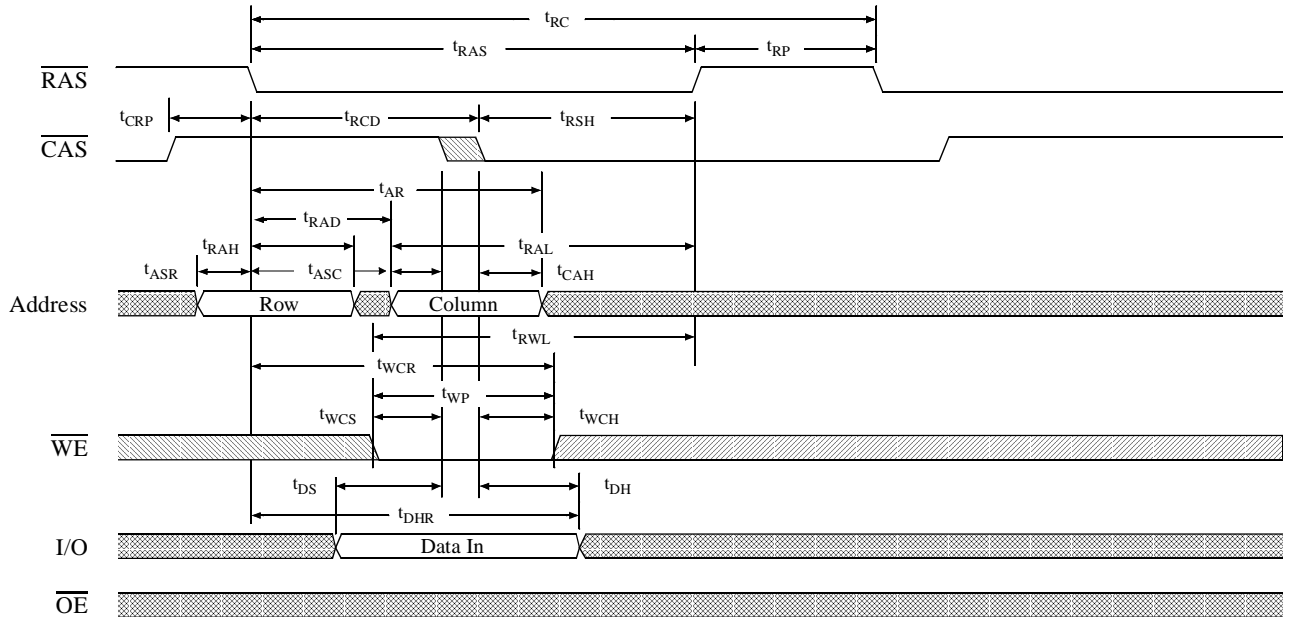



Timing waveform of $\overline{\text{CAS}}$ before $\overline{\text{RAS}}$ refresh counter test cycle

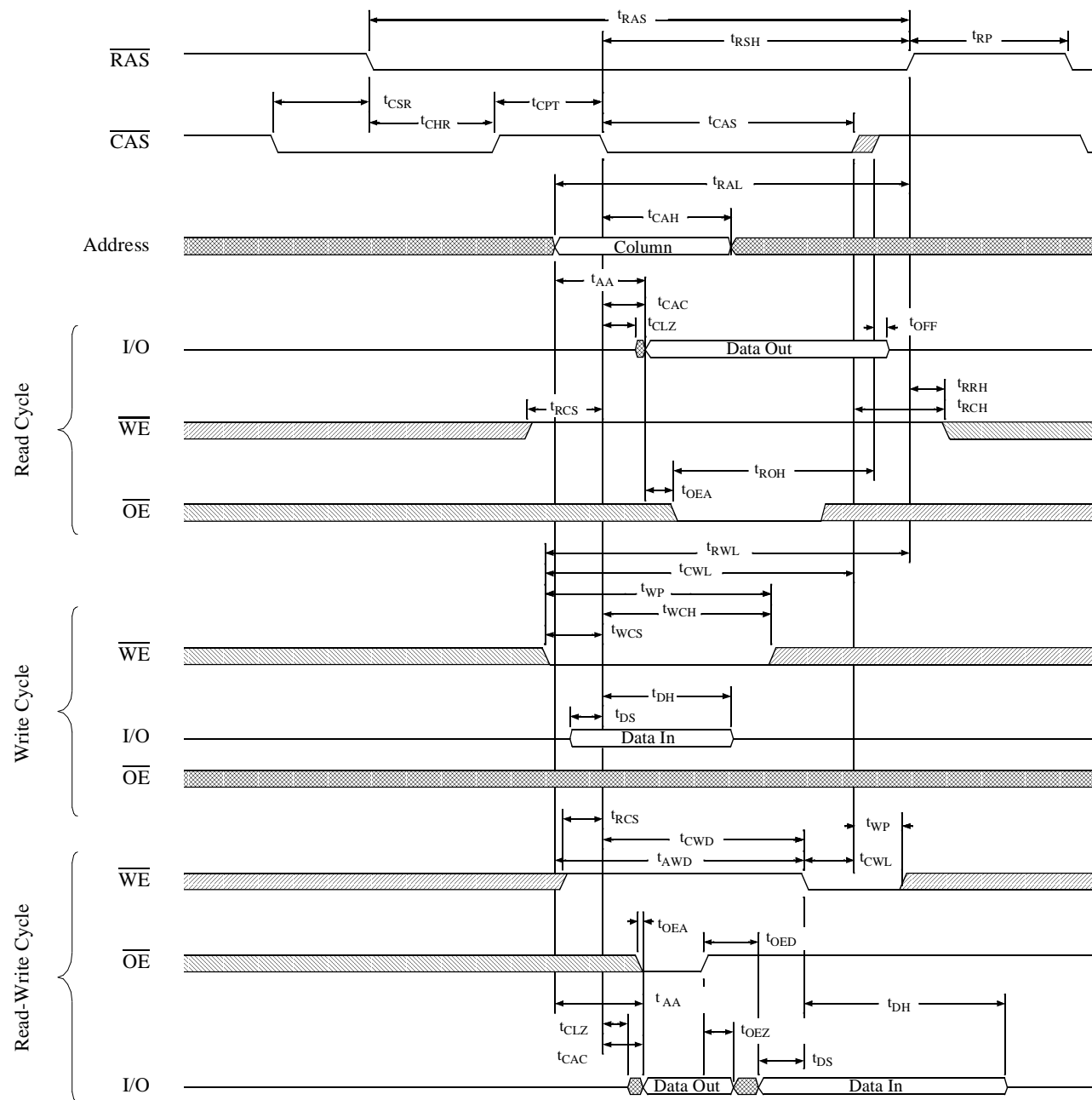



Typical DC and AC characteristics

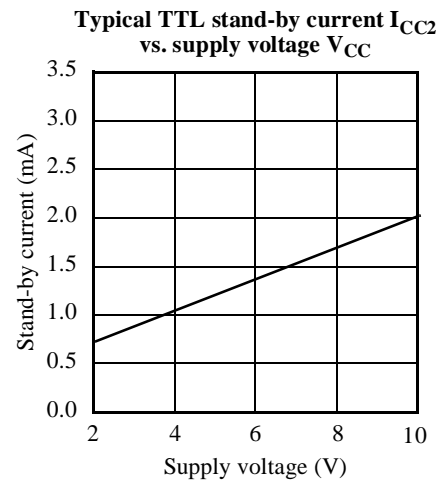
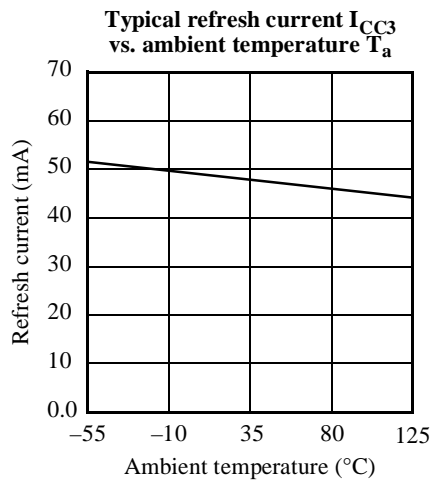
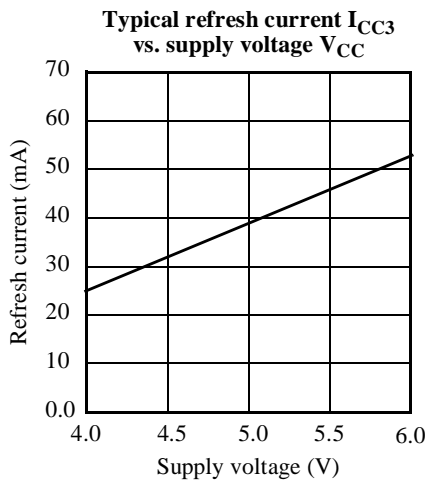
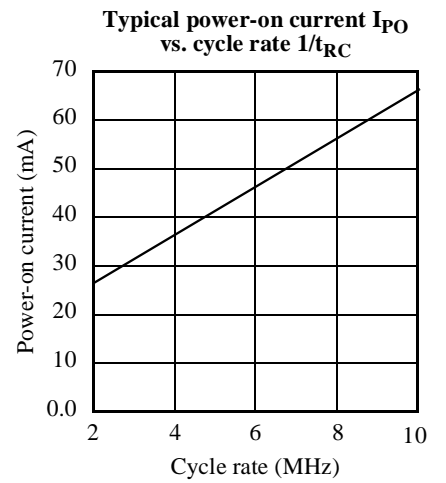
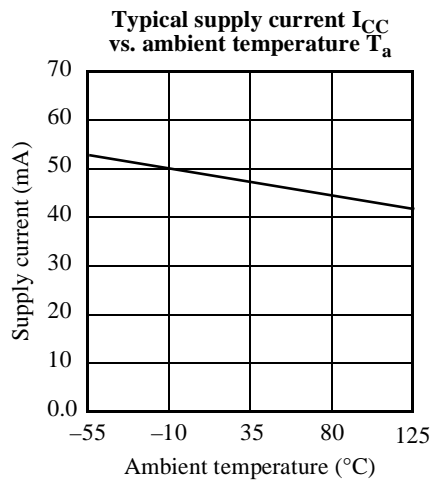
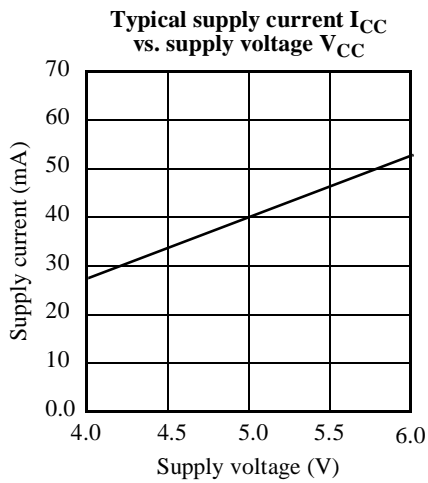
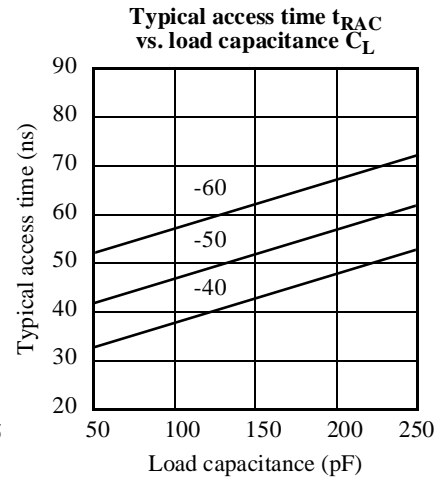
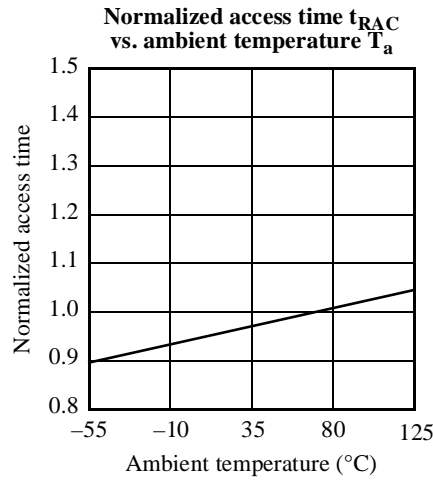
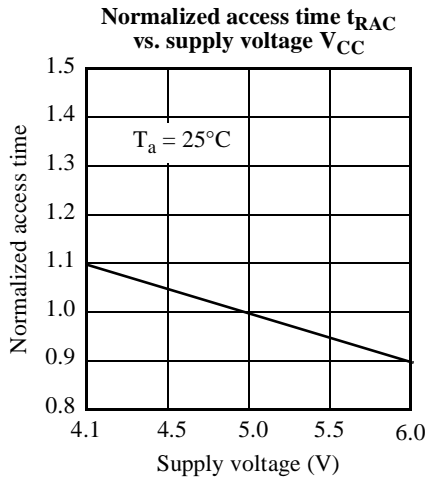

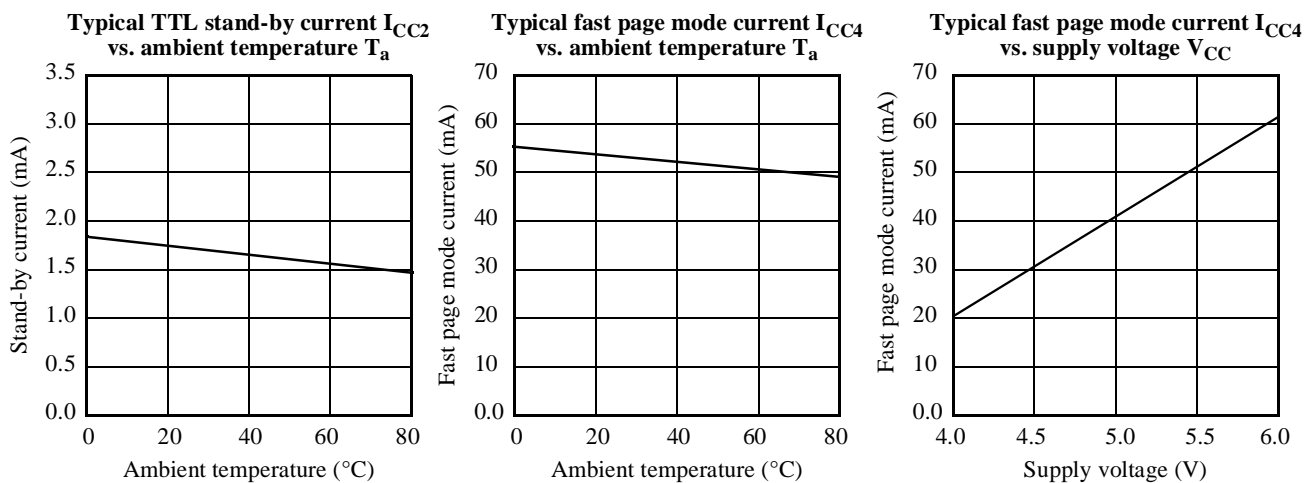

Capacitance

($f = 1 \text{ MHz}$, $T_a = \text{Room Temperature}$)

Parameter	Symbol	Signals	Test Conditions	Max	Unit
Input capacitance	C_{IN1}	A0 to A8	$V_{in} = 0V$	5	pF
	C_{IN2}	$\overline{\text{RAS}}$, $\overline{\text{CAS}}$, $\overline{\text{WE}}$, $\overline{\text{OE}}$	$V_{in} = 0V$	7	pF
I/O capacitance	$C_{I/O}$	I/O0 to I/O3	$V_{in} = V_{out} = 0V$	7	pF



Ordering codes

Package \ RAS Access Time	40 ns	50 ns	60 ns	70 ns
Plastic SOJ, 300 mil, 20/26-pin	AS4C14400-40JC AS4C14405-40JC	AS4C14400-50JC AS4C14405-50JC	AS4C14400-60JC AS4C14405-60JC	AS4C14400-70JC AS4C14405-70JC
Plastic TSOP, 300 mil, 20/26-pin	AS4C14400-40TC AS4C14405-40TC	AS4C14400-50TC AS4C14405-50TC	AS4C14400-60TC AS4C14405-60TC	AS4C14400-70TC AS4C14405-70TC

Shaded areas contain advance information.

Part numbering system

AS4C	14400	-XX	X	C
DRAM Prefix	Device number	RAS access time	Package: J = SOJ 300 mil, T = TSOP 300 mil	Commercial temperature range, 0°C to 70 °C

Representatives, distributors, and sales offices

DOMESTIC REPS

ALABAMA

Concord Component
(205) 772-8883

ARKANSAS

Southern States Marketing
(214) 238-7500

CALIFORNIA

NORTH
Brooks Technical
(415) 960-3880

LA AREA
Competitive Tech.
(714) 450-0170

SAN DIEGO
ATS
(619) 634-1488

COLORADO

Technology Sales
(303) 692-8835

CONNECTICUT

Kitchen & Kutchin
(203) 239-0212

DELAWARE

Electro Tech
(610) 272-2125

FLORIDA

Micro-Electronic Comp.

DEERFIELD BEACH
(954) 426-8944

ORLANDO
(407) 682-9602

TAMPA
(813) 393-5011

GEORGIA

Concord Component
(770) 416-9597

HAWAII

Brooks Technical
(415) 960-3880

IDAHO
ES/Chase
(503) 684-8500

ILLINOIS

NORTH
El-Mech
(312) 794-9100

SOUTH
CenTech
(314) 291-4230

INDIANA
CC Electro Sales
(317) 921-5000

KANSAS

CenTech
(816) 358-8100

KENTUCKY

CC Electro Sales
(317) 921-5000

LOUISIANA

Southern States Marketing

NORTH
(214) 238-7500

SOUTH
(713) 895-8533

MAINE

Kitchen & Kutchin
(617) 229-2660

MARYLAND

Chesapeake Tech.
(301) 236-0530

MASSACHUSETTS

Kitchen & Kutchin
(617) 229-2660

MICHIGAN

Enco Group
(810) 338-8600

MINNESOTA

D. A. Case Associates
(612) 831-6777

MISSOURI

CenTech

EAST
(314) 291-4230

WEST
(816) 358-8100

MISSISSIPPI

Concord Component
(205) 772-8883

MONTANA

ES/Chase
(503) 684-8500

NEBRASKA

CenTech
(816) 358-8100

NEVADA

Brooks Technical
(415) 960-3880

NEW HAMPSHIRE

Kitchen & Kutchin
(617) 229-2660

NEW JERSEY

NORTH
ERA Associates
(800) 645-5500

SOUTH
Electro Tech
(610) 272-2125

NEW YORK

NYC
ERA Associates
(516) 543-0510

UPSTATE
Tri-Tech

ROCHESTER
(716) 385-6500

BINGHAMTON
(607) 722-3580

NORTH CAROLINA

Concord Component
(919) 846-3441

NORTH DAKOTA

D. A. Case Associates
(612) 831-6777

OHIO

Midwest Marketing Assoc.

LYNDHURST
(216) 381-8575

DAYTON

(513) 433-2511

OKLAHOMA

Southern States Marketing
(214) 238-7500

OREGON

ES/Chase
(503) 684-8500

PENNSYLVANIA

EAST
Electro Tech
(610) 272-2125

WEST
Midwest Marketing
(216) 381-8575

RHODE ISLAND

Kitchen & Kutchin
(617) 229-2660

SOUTH CAROLINA

Concord Component
(919) 846-3441

SOUTH DAKOTA

D. A. Case Associates
(612) 831-6777

TENNESSEE

Concord Component
(205) 772-8883

TEXAS

Southern States Marketing

AUSTIN
(512) 835-5822

DALLA
(214) 238-7500

HOUSTON
(713) 895-8533

UTAH

Charles Fields & Assoc.
(801) 299-8228

VERMONT

Kitchen & Kutchin
(617) 229-2660

VIRGINIA

Chesapeake Tech.
(301) 236-0530

WASHINGTON

ES/Chase
(206) 823-9535

WEST VIRGINIA

Chesapeake Tech.
(301) 236-0530

WISCONSIN

D. A. Case Associates
(612) 831-6777

WYOMING

Technology Sales
(303) 692-8835

INTERNATIONAL REPS

AUSTRALIA

DINGLEY
R&D Electronics
+61-3-9558-0444

BAYSWATER
ACD
+61-3-9762-7644

CANADA

J-Squared Technologies

OTTAWA
(613) 592-9540

TORONTO
(905) 672-2030

MONTREAL
(514) 747-1211

VANCOUVER
(604) 473-4666

CALGARY
(403) 291-6755

EUROPE

Britcomp Sales

SURREY, ENGLAND
+44-1932 347077
+44-1932 346256

MUNICH, GERMANY
+49-894488496

ATHISMONS, FRANCE
+33-1-69387678

interACTIVE

GREAT BRITAIN, IRELAND
+44-1773-740263

Ramtec Int'l B.V.

HOLLAND, SPAIN, ITALY,
BELGIUM, HUNGARY, RUSSIA
+31-2526-21222

HONG KONG

Eastele Technology
+852-2798-8860

INDIA

Priya Electronics, Inc.
San Jose, CA USA
(408) 954-1866

Satcom Sales & Svcs.
+91-40-761-4675

ISRAEL

Eldis Technology
+972-9-562-6666

JAPAN

TOKYO
Bussan Micro Electronics
+81-3-5421-1730

KYOTO

Rohm Co. Ltd.
+81-75-311-2121

KOREA

FM Korea
+822-596-3880
fm@ktnet.co.kr

Woo Young Tech
+822-369-7099

MALAYSIA

Exer Technologies
+65-741-4655

PUERTO RICO

Micro-Electronic Comp.
(787) 746-9897

SINGAPORE

Exer Technologies
+60-4-657-9592

TAIWAN

Asian Specific Tech.
+886-2-521-2363

Golden Way Electronics
+886-2-698-1868 x505

Puteam International
+886-2-729-0373

DISTRIBUTORS

All American
HQ: (305) 621-8282

Axis: Components, Inc.
HQ: (800) 556-0225

Future Electronics
HQ: (514) 594-7710

Interface Electronics
HQ: (800) 632-7792

Please contact your rep to
locate a distributor near you

SALES OFFICES

HEADQUARTERS

Alliance Semiconductor
San Jose, CA
(408) 383-4900

NORTHEAST AREA

Alliance Semiconductor
Boston, MA
(617) 239-8127

TECHNICAL CENTER

TAIWAN

Alliance Semiconductor
Tel: +886-2-516-7995
Fax: +886-2-517-4928
alliance@netra.wow.net.tw

Alliance Semiconductor reserves the right to make changes in this data sheet at any time to improve design and supply the best product possible. Publication of advance information does not constitute a commitment to produce or supply the product described. The company cannot assume responsibility for circuits shown or represent that they are free from patent infringement. Alliance products are not authorized for use as critical components in life support devices or systems without the express written approval of the president of Alliance. ProMotion[®] and the Alliance logo are registered trademarks of Alliance Semiconductor Corporation. All other trademarks are property of their respective holders.

ALLIANCE SEMICONDUCTOR

3099 North First Street San Jose, CA 95134

(408) 383-4900 Fax (408) 383-4999

Copyright © 1996 All rights reserved.