

*Single switch
Series & parallel diodes
MOSFET Power Module*

**$V_{DSS} = 200V$
 $R_{DSon} = 9m\Omega$ max @ $T_j = 25^\circ C$
 $I_D = 195A$ @ $T_c = 25^\circ C$**

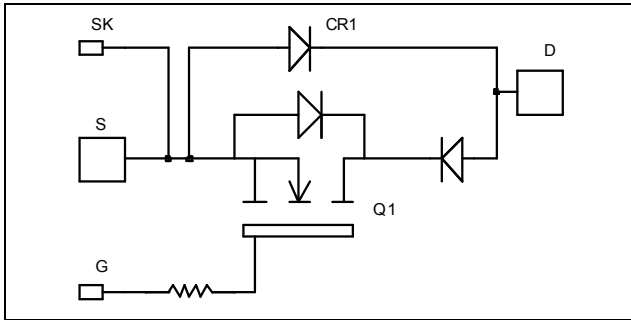

Application

- Motor control
- Switched Mode Power Supplies
- Uninterruptible Power Supplies

Features

- Power MOS 7[®] MOSFETs
 - Low R_{DSon}
 - Low input and Miller capacitance
 - Low gate charge
 - Avalanche energy rated
 - Very rugged
- Kelvin source for easy drive
- Low stray inductance
 - M6 power connectors
 - M4 signal connectors
- High level of integration

Benefits

- Outstanding performance at high frequency operation
- Direct mounting to heatsink (isolated package)
- Low junction to case thermal resistance

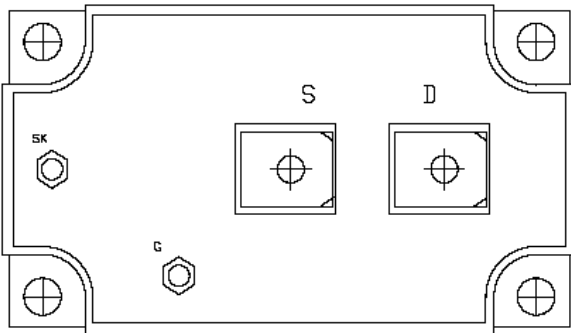

Absolute maximum ratings

Symbol	Parameter	Max ratings	Unit
V_{DSS}	Drain - Source Breakdown Voltage	200	V
I_D	Continuous Drain Current	$T_c = 25^\circ C$	195
		$T_c = 80^\circ C$	145
I_{DM}	Pulsed Drain current	780	A
V_{GS}	Gate - Source Voltage	± 30	V
R_{DSon}	Drain - Source ON Resistance	9	$m\Omega$
P_D	Maximum Power Dissipation	$T_c = 25^\circ C$	780
I_{AR}	Avalanche current (repetitive and non repetitive)	65	A
E_{AR}	Repetitive Avalanche Energy	30	mJ
E_{AS}	Single Pulse Avalanche Energy	1300	

CAUTION: These Devices are sensitive to Electrostatic Discharge. Proper Handling Procedures Should Be Followed.

All ratings @ $T_j = 25^\circ\text{C}$ unless otherwise specified

Electrical Characteristics

Symbol	Characteristic	Test Conditions	Min	Typ	Max	Unit
BV_{DSS}	Drain - Source Breakdown Voltage	$V_{GS} = 0V, I_D = 1mA$	200			V
I_{DSS}	Zero Gate Voltage Drain Current	$V_{GS} = 0V, V_{DS} = 200V$ $T_j = 25^\circ\text{C}$			400	μA
		$V_{GS} = 0V, V_{DS} = 160V$ $T_j = 125^\circ\text{C}$			2000	
$R_{DS(on)}$	Drain - Source on Resistance	$V_{GS} = 10V, I_D = 74.5A$			9	$\text{m}\Omega$
$V_{GS(th)}$	Gate Threshold Voltage	$V_{GS} = V_{DS}, I_D = 4mA$	3		5	V
I_{GSS}	Gate - Source Leakage Current	$V_{GS} = \pm 30V, V_{DS} = 0V$			± 400	nA

Dynamic Characteristics

Symbol	Characteristic	Test Conditions	Min	Typ	Max	Unit
C_{iss}	Input Capacitance	$V_{GS} = 0V$ $V_{DS} = 25V$ $f = 1MHz$		12.3		nF
C_{oss}	Output Capacitance			4		
C_{rss}	Reverse Transfer Capacitance			0.39		
Q_g	Total gate Charge	$V_{GS} = 10V$ $V_{Bus} = 100V$ $I_D = 195A$		217		nC
Q_{gs}	Gate - Source Charge			143		
Q_{gd}	Gate - Drain Charge			157		
$T_{d(on)}$	Turn-on Delay Time	Inductive switching @ 125°C $V_{GS} = 15V$ $V_{Bus} = 133V$ $I_D = 195A$ $R_G = 1.2\Omega$		28		ns
T_r	Rise Time			56		
$T_{d(off)}$	Turn-off Delay Time			81		
T_f	Fall Time			99		
E_{on}	Turn-on Switching Energy ①	Inductive switching @ 25°C $V_{GS} = 15V, V_{Bus} = 133V$ $I_D = 195A, R_G = 1.2\Omega$		1029		μJ
E_{off}	Turn-off Switching Energy ②			1011		
E_{on}	Turn-on Switching Energy ①	Inductive switching @ 125°C $V_{GS} = 15V, V_{Bus} = 133V$ $I_D = 195A, R_G = 1.2\Omega$		1351		μJ
E_{off}	Turn-off Switching Energy ②			1180		

Series diode ratings and characteristics

Symbol	Characteristic	Test Conditions	Min	Typ	Max	Unit
$I_{F(AV)}$	Maximum Average Forward Current	50% duty cycle $T_c = 85^\circ\text{C}$		120		A
V_F	Diode Forward Voltage	$I_F = 120A$		1.1	1.15	V
		$I_F = 240A$		1.4		
		$I_F = 120A$ $T_j = 125^\circ\text{C}$		0.9		
t_{rr}	Reverse Recovery Time	$I_F = 120A$ $T_j = 25^\circ\text{C}$		31		ns
		$V_R = 133V$ $T_j = 125^\circ\text{C}$ $di/dt = 400A/\mu\text{s}$		60		
Q_{rr}	Reverse Recovery Charge	$I_F = 120A$ $T_j = 25^\circ\text{C}$		120		nC
		$V_R = 133V$ $T_j = 125^\circ\text{C}$ $di/dt = 400A/\mu\text{s}$		500		

① E_{on} includes diode reverse recovery.

② In accordance with JEDEC standard JESD24-1.

Parallel diode ratings and characteristics

<i>Symbol</i>	<i>Characteristic</i>	<i>Test Conditions</i>		<i>Min</i>	<i>Typ</i>	<i>Max</i>	<i>Unit</i>
$I_{F(AV)}$	Maximum Average Forward Current	50% duty cycle	$T_c = 90^\circ\text{C}$		100		A
V_F	Diode Forward Voltage	$I_F = 100\text{A}$			1	1.1	V
		$I_F = 200\text{A}$			1.4		
		$I_F = 100\text{A}$	$T_j = 125^\circ\text{C}$		0.9		
t_{rr}	Reverse Recovery Time	$I_F = 100\text{A}$ $V_R = 133\text{V}$ $di/dt = 200\text{A}/\mu\text{s}$	$T_j = 25^\circ\text{C}$		60		ns
			$T_j = 125^\circ\text{C}$		110		
Q_{rr}	Reverse Recovery Charge	$I_F = 100\text{A}$ $V_R = 133\text{V}$ $di/dt = 200\text{A}/\mu\text{s}$	$T_j = 25^\circ\text{C}$		200		nC
			$T_j = 125^\circ\text{C}$		840		

Thermal and package characteristics

<i>Symbol</i>	<i>Characteristic</i>		<i>Min</i>	<i>Typ</i>	<i>Max</i>	<i>Unit</i>
R_{thJC}	Junction to Case	Transistor			0.16	$^\circ\text{C}/\text{W}$
		Series diode			0.46	
		Parallel diode			0.6	
V_{ISOL}	RMS Isolation Voltage, any terminal to case $t = 1\text{ min}$, $I_{isol} < 1\text{mA}$, 50/60Hz		2500			V
T_J	Operating junction temperature range		-40		150	$^\circ\text{C}$
T_{STG}	Storage Temperature Range		-40		125	
T_C	Operating Case Temperature		-40		100	
Torque	Mounting torque	M4			1.2	
		M6	3		5	
Wt	Package Weight				400	g

Package outline

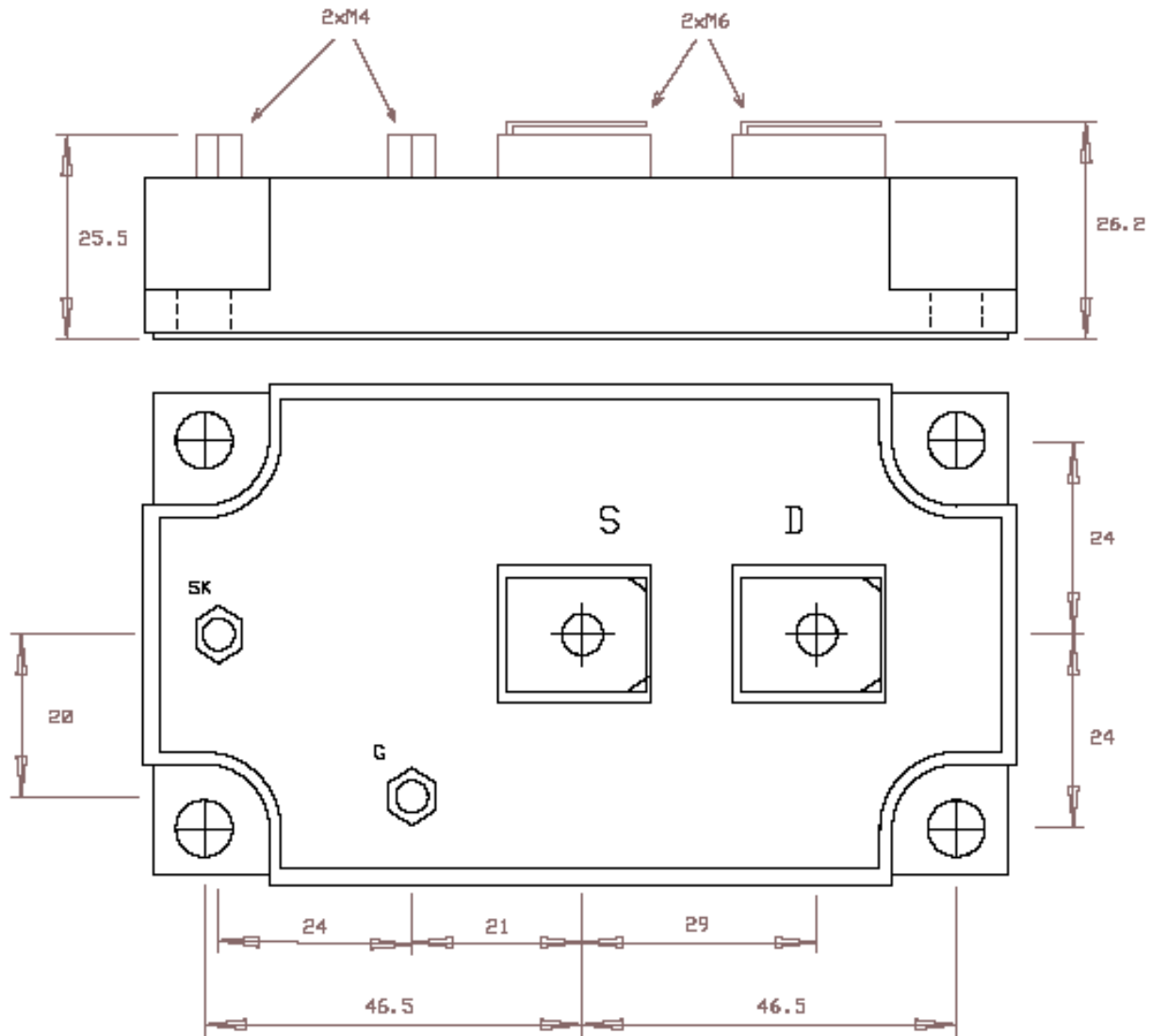

GENERAL TOLERANCES : +/-0.5mm

Mounting holes: 4xØ6.5 mm

Typical Performance Curve

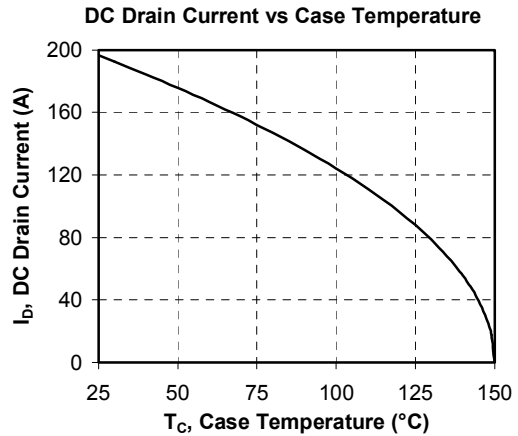
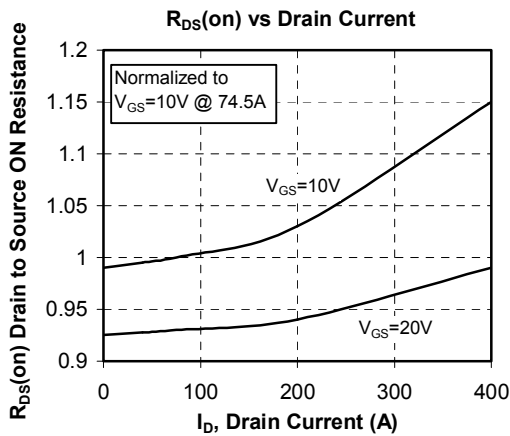
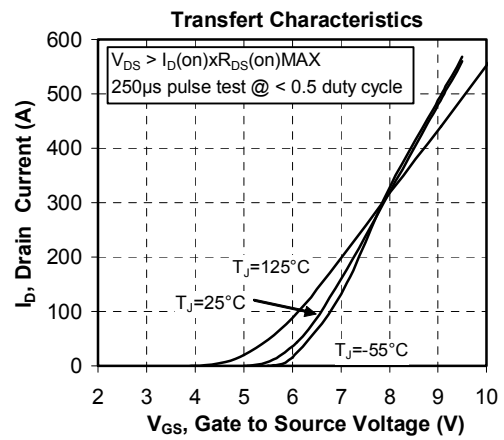
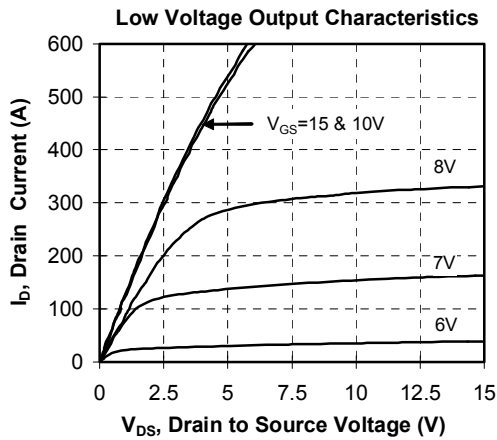
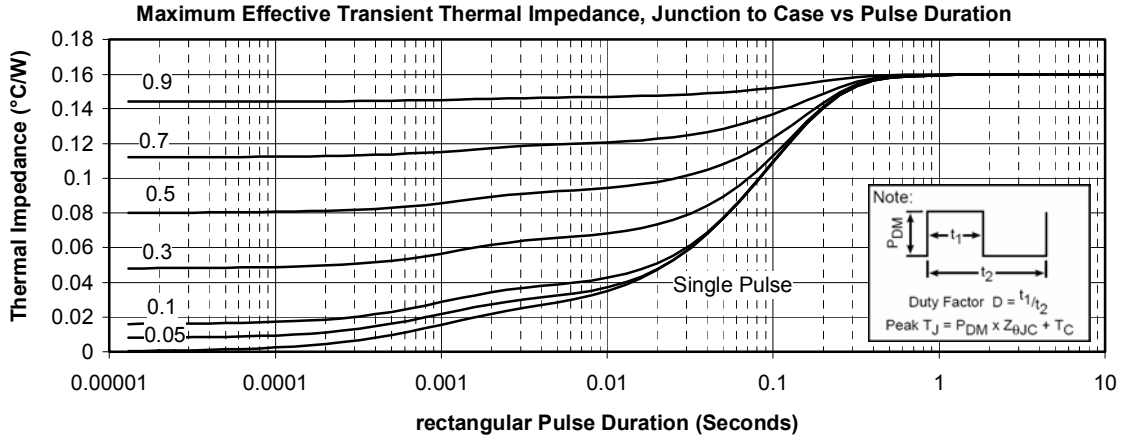

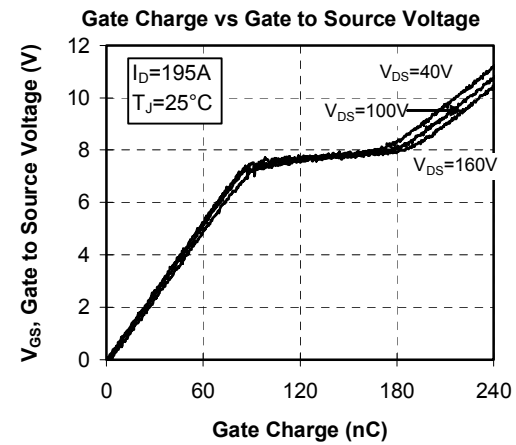
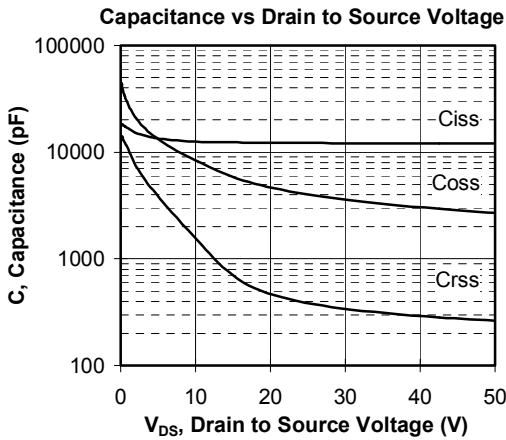
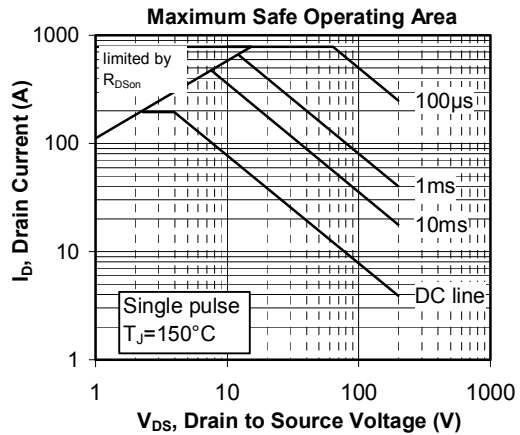
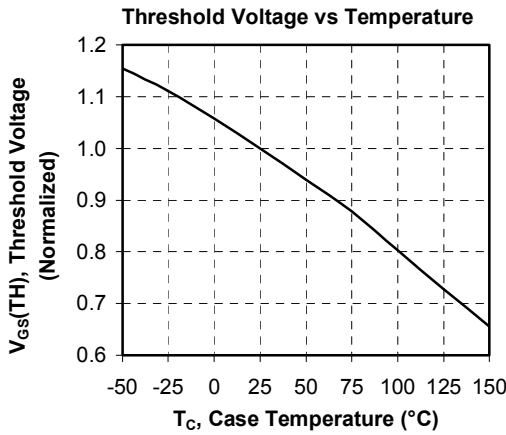
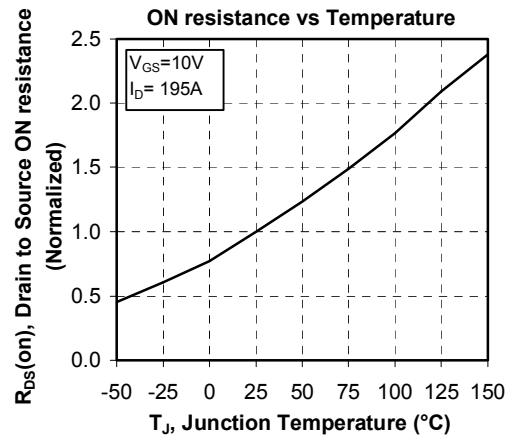
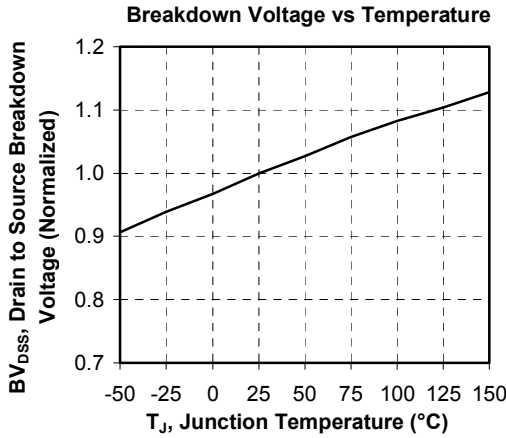

Delay Times vs Current

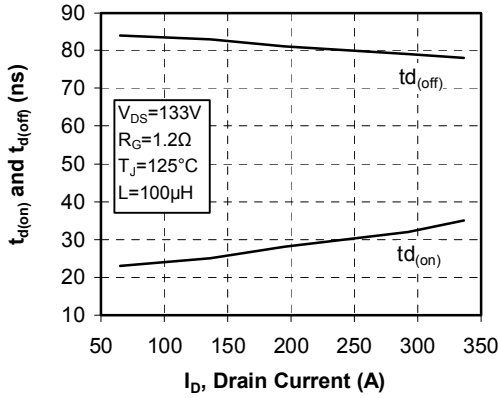

Rise and Fall times vs Current

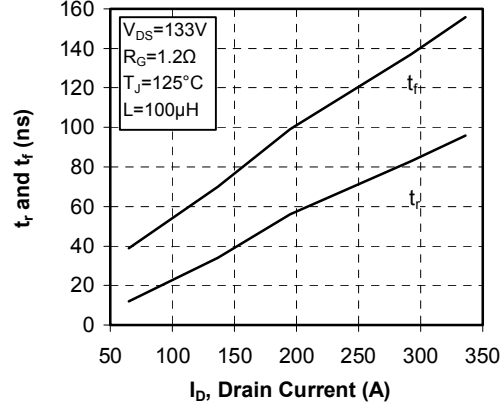

Switching Energy vs Current

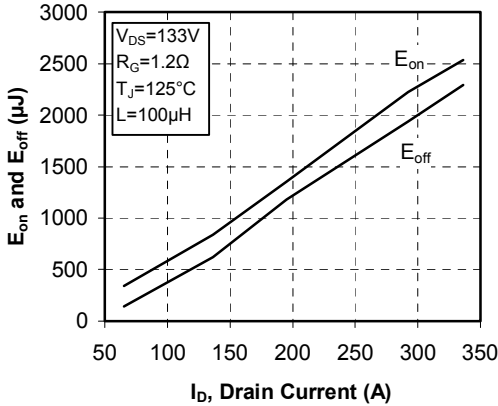

Switching Energy vs Gate Resistance

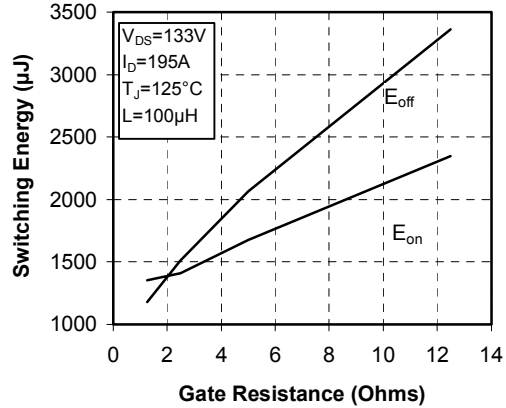

Operating Frequency vs Drain Current

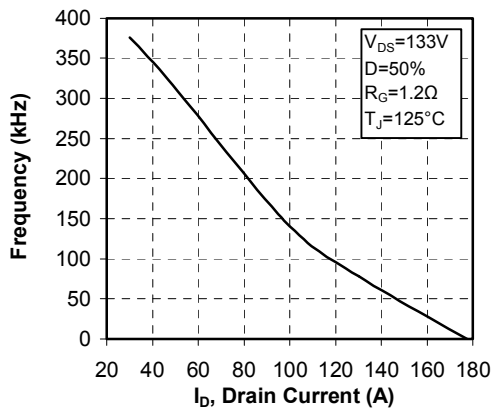

Source to Drain Diode Forward Voltage

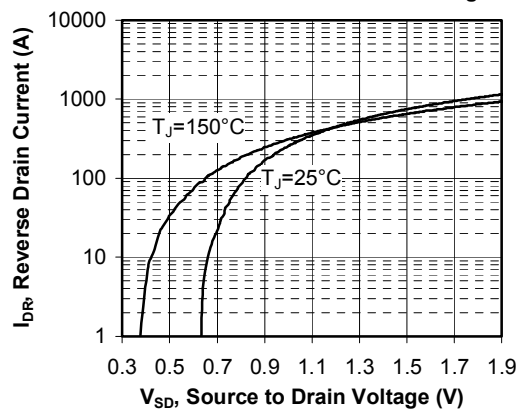

APT reserves the right to change, without notice, the specifications and information contained herein

APT's products are covered by one or more of U.S. patents 4,895,810 5,045,903 5,089,434 5,182,234 5,019,522 5,262,336 6,503,786 5,256,583 4,748,103 5,283,202 5,231,474 5,434,095 5,528,058 and foreign patents. U.S. and Foreign patents pending. All Rights Reserved.