

ACFM-7107

PCS/Cellular Band Quadplexer

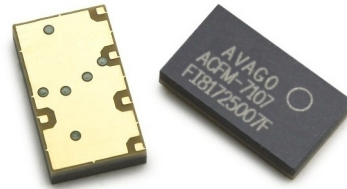

Data Sheet



Description

The Avago Technologies' ACFM-7107 is a quadplexer that combines PCS and Cellular duplexers into a single, miniature package.

The ACFM-7107 features a single antenna connection, eliminating the need for antenna switching.

The ACFM-7107 is designed with Avago Technologies' Film Bulk Acoustic Resonator (FBAR) technology. The ACFM-7107 also utilizes Avago Technologies' innovative Microcap bonded-wafer, chip scale packaging technology. This process allows the filters to be assembled in a module with a footprint of only 4 x 7 mm with a maximum height of 1.2 mm.

Low Tx Insertion Loss of the ACFM-7107 reduces power amplifier current, extending battery life and talk time. The ACFM-7107 enhances receiver sensitivity and dynamic range with low Rx Insertion Loss and high rejection of Tx signals at the Rx ports.

The excellent power handling capability of Avago Technologies' FBAR bulk-mode resonators supports the high Tx output power levels needed in handsets while adding virtually no distortion.

Functional Block Diagram

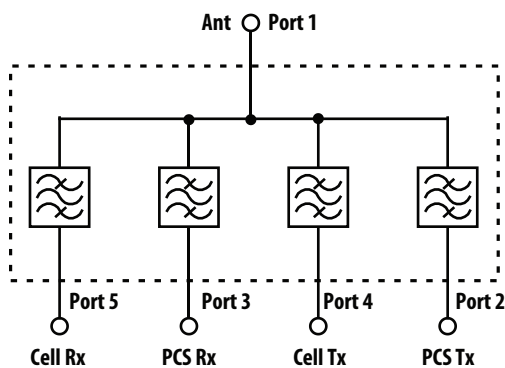

Features

- Single Antenna
- Miniature size
 - 4 x 7 mm footprint
 - 1.2 mm Max height
- High Power Rating
 - +33 dBm Max Tx Power
- Environmental
 - RoHS Compliant
 - Halogen Free
 - TBBPA Free

Specifications

- Performance guaranteed -30 to +85°C
- Cellular Duplexer Rx (869 – 894 MHz)
 - Insertion Loss: 3.6 dB Max, 1.4 dB Typ (25°C)
 - Noise Blocking: 40 dB Min
- Cellular Duplexer Tx (824 – 849 MHz)
 - Insertion Loss: 2.9 dB Max, 1.2 dB Typ (25°C)
 - Interferer Blocking: 55 dB Min
- PCS Duplexer Rx (1930.5 – 1989.5 MHz)
 - Insertion Loss: 3.6 dB Max, 1.6 dB Typ (25°C)
 - Noise Blocking: 40 dB Min
- PCS Duplexer Tx (1850.5 – 1909.5 MHz)
 - Insertion Loss: 3.1 dB Max, 1.3 dB Typ (25°C)
 - Interferer Blocking: 53 dB Min

Applications

- Handsets or data terminals operating in the PCS and Cellular frequency bands

ACFM-7107 Electrical Specifications, $Z_0=50\ \Omega$, $T_c^{[1] [2][4]}$ as indicated

Symbol	Parameter	Units	- 30°C		+25°C			+85°C			
			Min	Typ ^[3]	Max	Min	Typ ^[3]	Max	Min	Typ ^[3]	Max
Cellular Duplexer Performance											
Antenna Port to Cellular Receive Port											
S41	Insertion Loss in Rx band (869–894 MHz)	dB			3.6		1.4	3.6			36
S41	Insertion Loss Ripple (p-p) in Rx Band (869–894 MHz)	dB						1.5			
S41	Attenuation in Tx band (824–849 MHz)	dB	55			55	65		50		
S41	Attenuation 0–804 MHz	dB	25			25	36		25		
S41	Attenuation in Tx 2 nd harmonic band (1648–1698 MHz)	dB	30			30	60		30		
S41	Attenuation in Tx 3 rd harmonic band (2472–2547 MHz)	dB	19			19	43		19		
S44	Return Loss (SWR) of Rx Port in Rx Band (869–894 MHz)	dB	9		(2.1)	9	17 (1.3)	(2.1)	9		(2.1)
S11	Return Loss (SWR) of Antenna Port in Rx Band (869–894 MHz)	dB	9		(2.1)	9	17 (1.3)	(2.1)	9		(2.1)
Cellular Transmit Port to Antenna Port											
S15	Insertion Loss in Tx band (824–849 MHz)	dB			2.9		1.2	2.9			2.9
S15	Insertion Loss Ripple (p-p) in Tx Band (824–849 MHz)	dB						1.5			
S15	Attenuation in Rx band (869–894 MHz)	dB	39			40	59		37		
S15	Attenuation, 0–804 MHz	dB	20			20	39		20		
S15	Attenuation in GPS band (1574.4–1576.4 MHz)	dB	37			37	43		37		
S15	Attenuation in Tx 2 nd harmonic band (1648–1698 MHz)	dB	20			20	39		20		
S15	Attenuation in Tx 3 rd harmonic band (2472–2547 MHz)	dB	8			8	25		8		
S55	Return Loss (SWR) of Tx Port in Tx band (824–849 MHz)	dB	9		(2.1)	9	14 (1.5)	(2.1)	9		(2.1)
S11	Return Loss (SWR) of Antenna port in Tx Band (824–849 MHz)	dB	9		(2.1)	9	14 (1.5)	(2.1)	9		(2.1)
Isolation, Cellular Transmit Port to Cellular Receive Port											
S45	Isolation, Tx to Rx port in Rx Band (869–894 MHz)	dB	40			40	59		40		
S45	Isolation, Tx to Rx port in Tx Band (824–849 MHz)	dB	55			55	65		55		

ACFM-7107 Electrical Specifications, $Z_0=50\ \Omega$, T_C ^{[1] [2][4]} as indicated

Symbol	Parameter	Units	- 30°C			+25°C			+85°C		
			Min	Typ ^[3]	Max	Min	Typ ^[3]	Max	Min	Typ ^[3]	Max
PCS Duplexer Performance											
Antenna Port to PCS Receive Port											
S31	Insertion Loss in Rx Band (1930.5–1989.5 MHz)	dB			3.6		1.6	3.6			3.6
S31	Insertion Loss Ripple (p-p) in Rx Band	dB						1.5			
S31	Attenuation in Tx Band (1850.5–1909.5 MHz)	dB	50			50	62		50		
S31	Attenuation 0.03–1770 MHz	dB	20			20	40		20		
S31	Attenuation 2025–3500 MHz	dB	30			30	60		30		
S31	Attenuation 3500–3700 MHz	dB	27			27	38		27		
S31	Attenuation 3820–4000 MHz	dB	23			23	30		23		
S33	Return Loss (SWR) of Rx Port in Rx Band (1930.5–1989.5 MHz)	dB	9		(2.1)	9	15 (1.4)	(2.1)	9		(2.1)
S11	Return Loss (SWR) of Antenna Port in Rx Band (1930.5–1989.5 MHz)	dB	9		(2.1)	9	18 (1.3)	(2.1)	9		(2.1)
PCS Transmit Port to Antenna Port											
S12	Insertion Loss in Tx Band (1850.5–1909.5 MHz)	dB			3.1		1.3	3.1			3.1
S12	Insertion Loss Ripple (p-p) in Tx Band	dB						1.5			
S12	Attenuation in Rx Band (1930.5–1989.5 MHz)	dB	39			39	48		39		
S12	Attenuation 0.03–1570 MHz	dB	15			15	43		15		
S12	Attenuation in GPS Band (1574.4–1576.4 MHz)	dB	27			27	31		27		
S12	Attenuation 1580 – 1700 MHz	dB	25			25	36		25		
S12	Attenuation in Tx 2 nd harmonic band (3701–3819 MHz)	dB	10			10	23		10		
S12	Attenuation in Tx 3 rd harmonic band (5551.5–5728.5 MHz)	dB	8			8	25		8		
S22	Return Loss (SWR) of Tx Port in Tx band (1850.5–1909.5 MHz)	dB	9.5		(2.0)	9.5	16 (1.4)	(2.0)	9.5		(2.0)
S11	Return Loss (SWR) of Antenna port in Tx Band (1850.5–1909.5 MHz)	dB	9		(2.1)	9	16 (1.4)	(2.1)	9		(2.1)
Isolation, PCS Transmit Port to PCS Receive Port											
S32	Isolation, Tx to Rx port in Rx Band (1930.5–1989.5 MHz)	dB	40			40	49		40		
S32	Isolation, Tx to Rx port in Tx Band (1850.5–1855 MHz)	dB	53			53	59		53		
			54			54	64		54		

Notes:

1. T_C is defined as Case Temperature, the temperature of the bottom mounting surface of the quadplexer where it makes contact with the circuit board.
2. Min/Max specifications are guaranteed at the indicated temperature with the input power to the Tx ports equal to or less than +29 dBm over all Tx frequencies unless otherwise noted.
3. Typical data is the arithmetic mean value of the parameter over its indicated frequency range at the specified temperature. Typical values may vary over time.
4. Specifications are for circuit shown in Figure 1 and include effect of 5.1 nH inductor and 1.0 pF capacitor added to Port 1 (Ant) via simulation.

Absolute Maximum Ratings^[1]

Parameter	Unit	Value
Storage temperature	°C	-65 to +125
Maximum RF Input Power to Tx Ports	dBm	+33

Maximum Recommended Operating Conditions^[2]

Parameter	Unit	Value
Operating temperature, T_c ^[3] , Tx Power \leq 29 dBm	°C	-40 to +100
Operating temperature, T_c ^[3] , Tx Power \leq 30 dBm	°C	-40 to +85

Notes:

1. Operation in excess of any one of these conditions may result in permanent damage to the device.
2. The device will function over the recommended range without degradation in reliability or permanent change in performance, but is not guaranteed to meet electrical specifications.
3. T_c is defined as Case Temperature, the temperature of the bottom mounting surface of the quadplexer where it makes contact with the circuit board.

Applications Information

The ACFM-7107 quadplexer has a single antenna connection common to the both the Cellular and PCS Band duplexers.

Operation

A two-element series-L, shunt-C network is used to match the impedance of the Ant port to 50 ohms as shown in Figure 1.

Matching Components

The nominal values for L and C shown here were selected to match the ACFM-7107 to 50 ohms. Since every application is different, these nominal values may need to be adjusted to provide the best impedance match for the user's particular circuit board, performance requirements, and interface to related components.

The L and C matching components should be located in close proximity to the quadplexer as shown in the recommended PCB layout.

The maximum tolerance for the matching components should be $\pm 5\%$ for the inductor and ± 0.2 pF for the capacitor. The inductor should be of the high Q type (e.g., Murata LQW15AN5N1D00D).

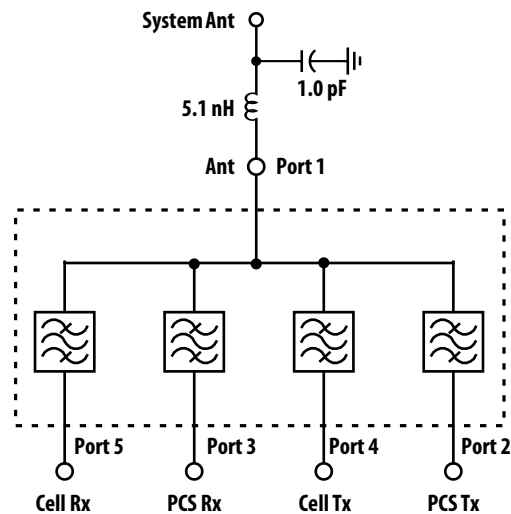

Figure 1. Typical Application.

ACFM-7107 Typical Performance at $T_c = 25^\circ\text{C}$. Includes Ant matching, refer to Note 1.

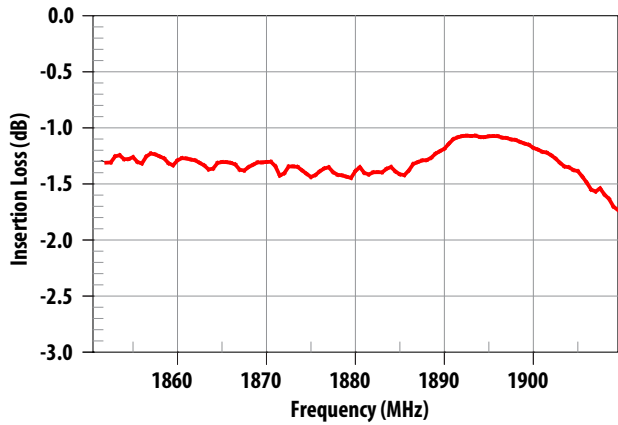

Figure 2. PCS Tx Band Insertion Loss.

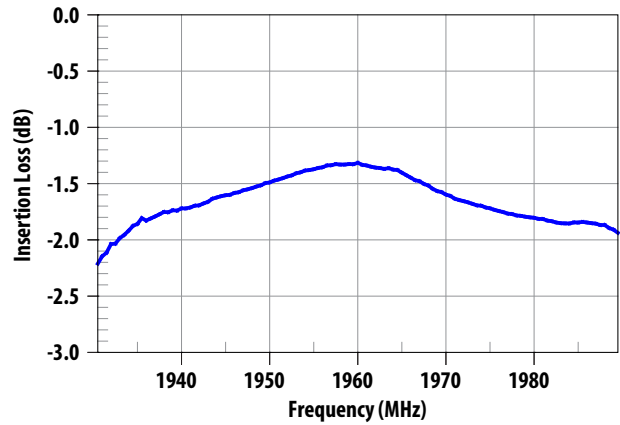

Figure 3. PCS Rx Band Insertion Loss.

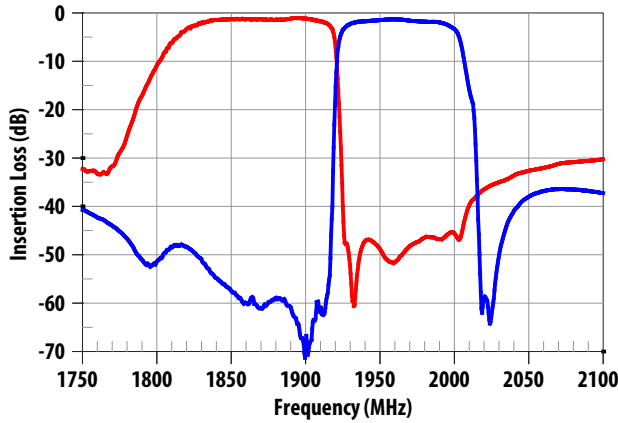

Figure 4. PCS Tx Rejection in Rx Band and Rx Rejection in Tx Band.

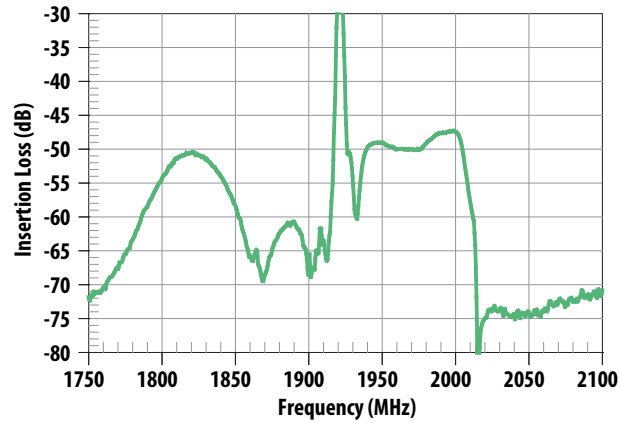

Figure 5. PCS Tx-Rx Isolation.

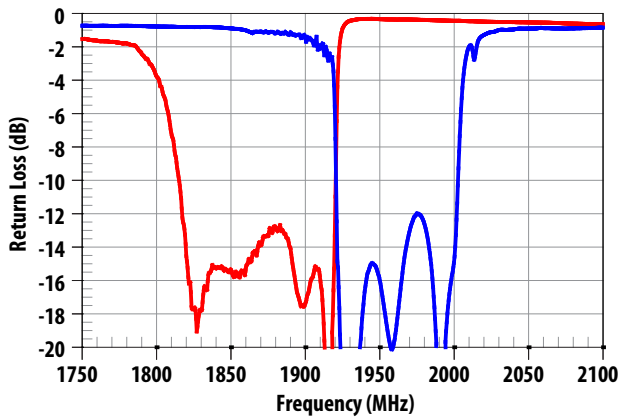

Figure 6. PCS Tx and Rx Port Return Loss.

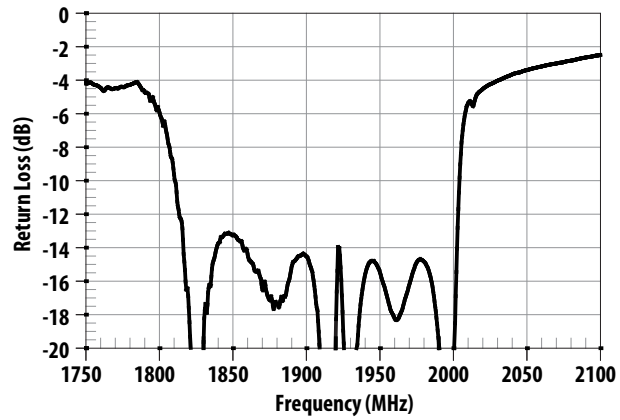

Figure 7. PCS Antenna Port Return Loss.

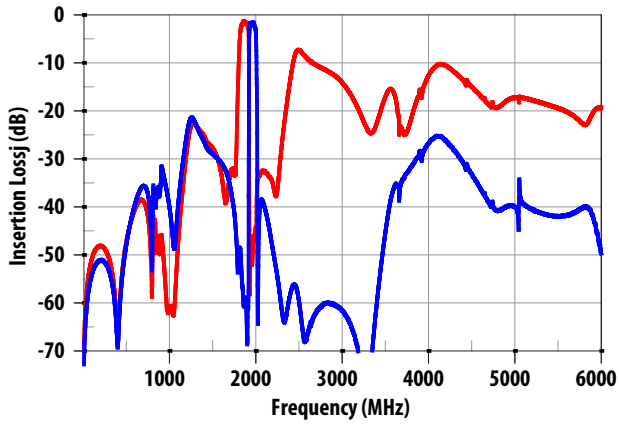

Figure 8. PCS Tx-Ant and Ant-Rx Wideband Insertion Loss.

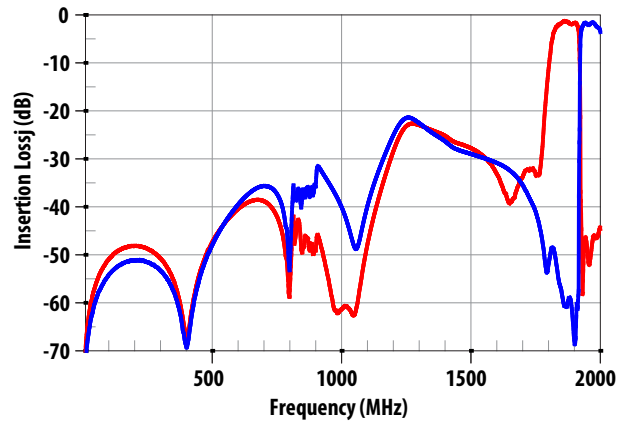

Figure 9. PCS Tx-Ant and Ant-Rx Low Frequency Insertion Loss.

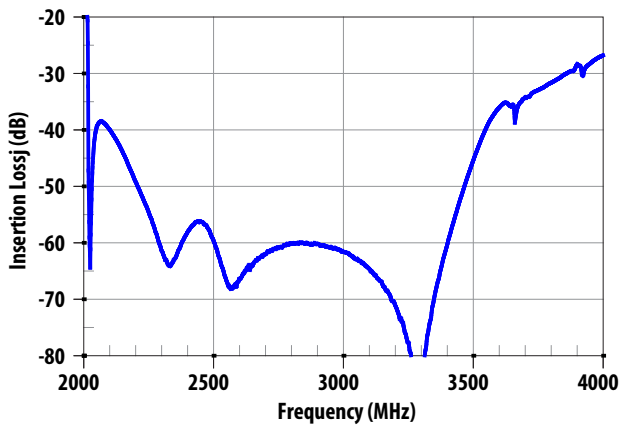

Figure 10. PCS Ant-Rx Rejection, 2000-4000 MHz.

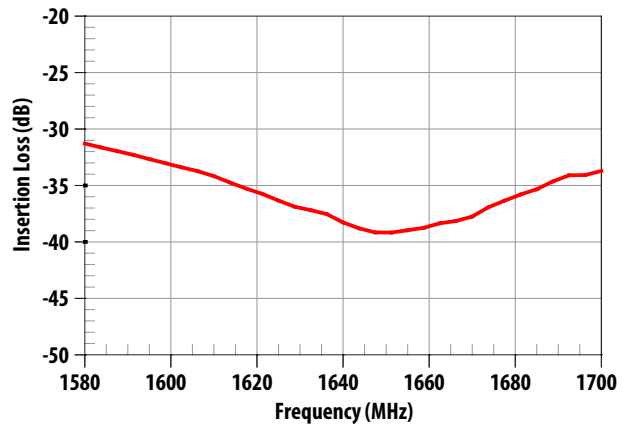

Figure 11. PCS Ant-Tx Rejection, 1580-1700 MHz.

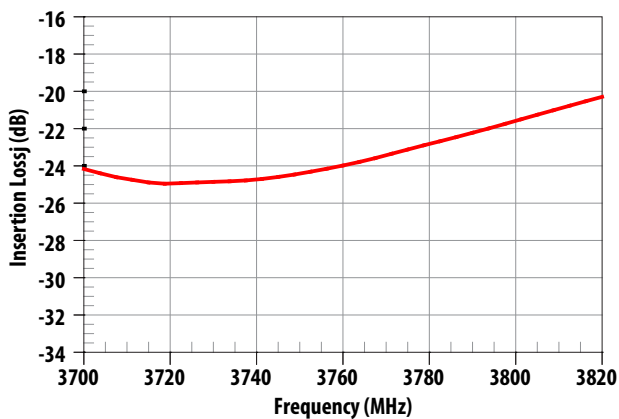

Figure 12. PCS Tx-Ant Rejection at Tx Second Harmonic.

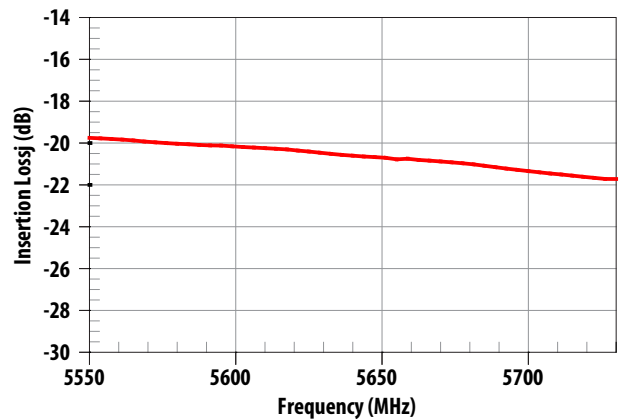

Figure 13. PCS Ant-Tx Rejection at Tx Third Harmonic.

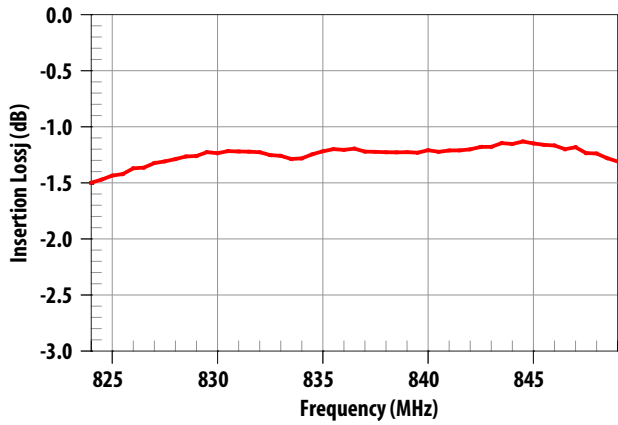

Figure 14. Cellular Tx Insertion Loss.

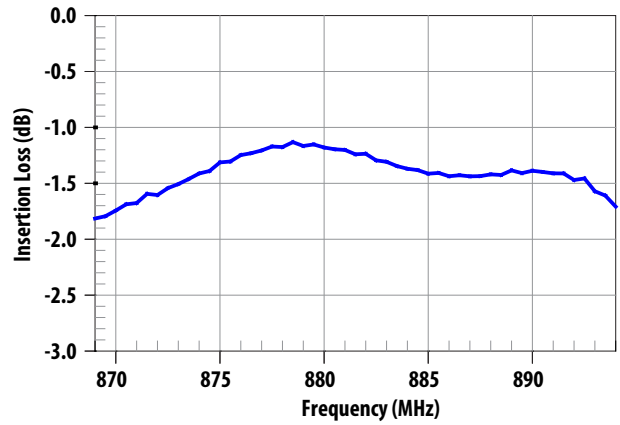

Figure 15. Cellular Rx Insertion Loss.

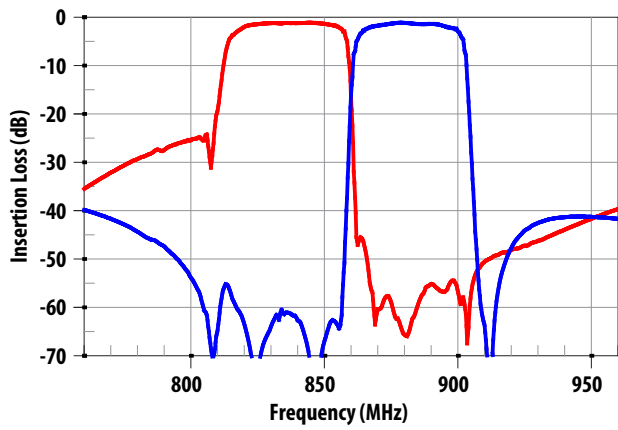

Figure 16. Cellular Tx Rejection in Rx Band and Rx Rejection in Tx Band.

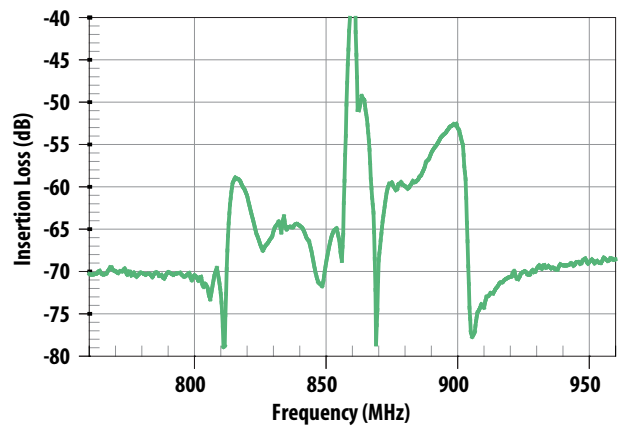

Figure 17. Cellular Tx-Rx Isolation.

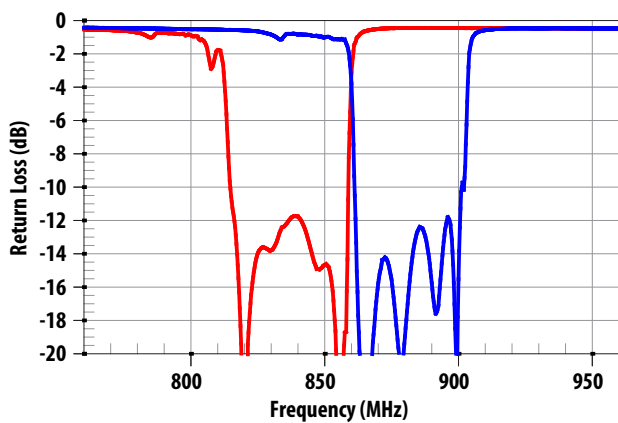

Figure 18. Cellular Tx and Rx Return Loss.

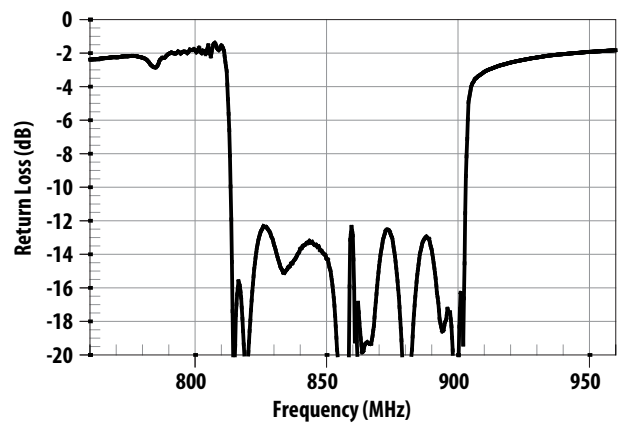

Figure 19. Cellular Band Antenna Return Loss.

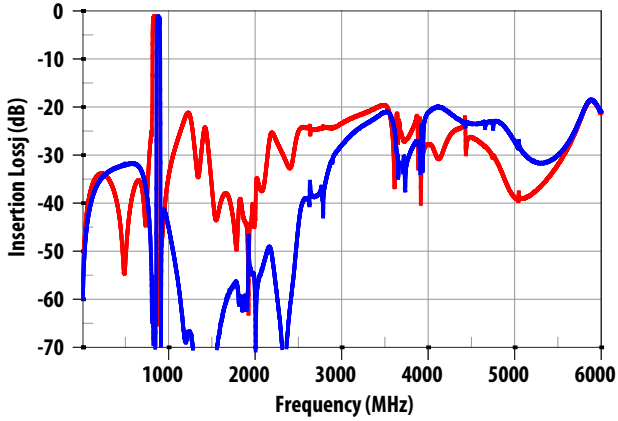

Figure 20. Cellular Tx-Ant and Ant-Rx Wideband Insertion Loss.

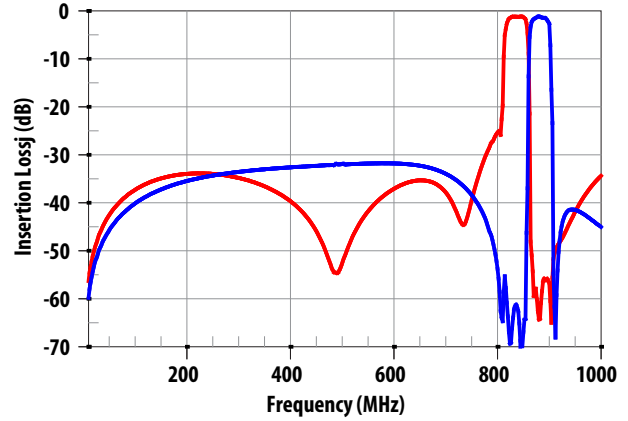

Figure 21. Cellular Tx-Ant and Ant-Rx Low Frequency Insertion Loss.

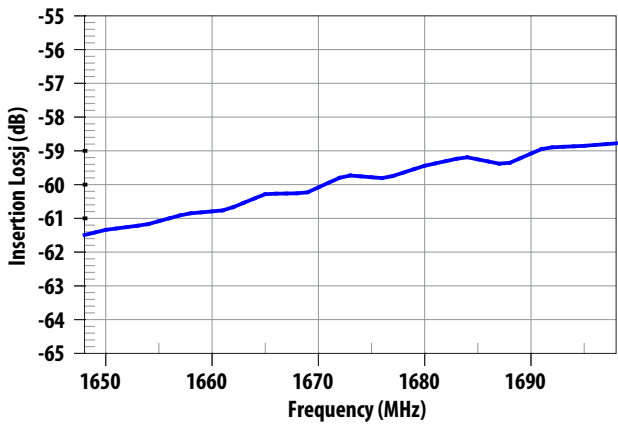

Figure 22. Cellular Ant-Rx Rejection at Tx Second Harmonic.

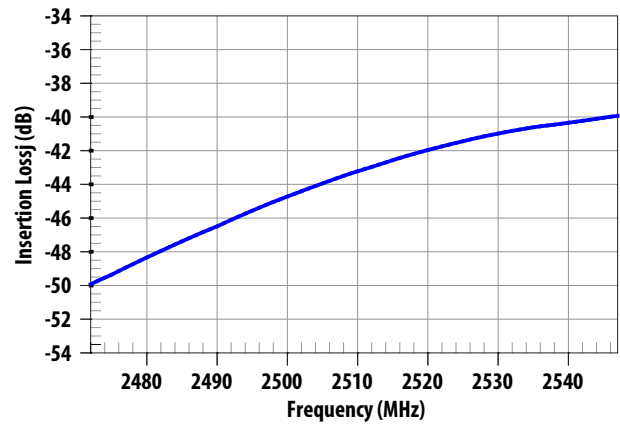

Figure 23. Cellular Ant-Rx Rejection at Tx Third Harmonic.

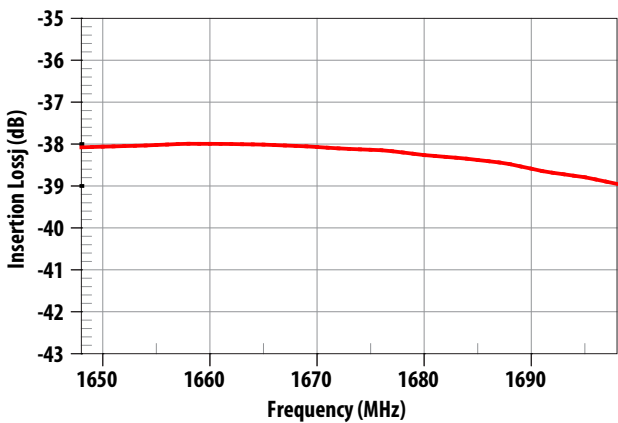

Figure 24. Cellular Tx-Ant Rejection at Tx Second Harmonic.

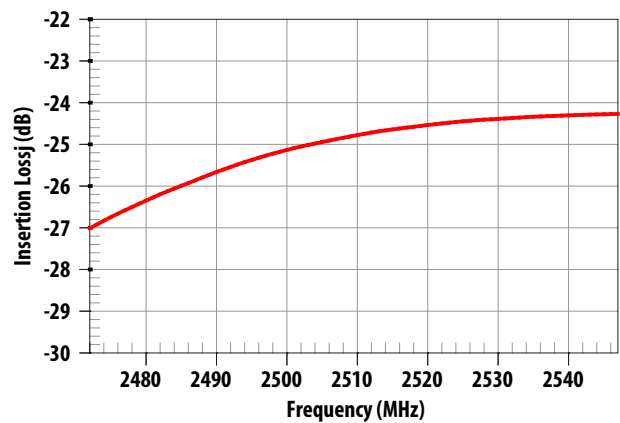

Figure 25. Cellular Tx-Ant Rejection at Tx Third Harmonic.

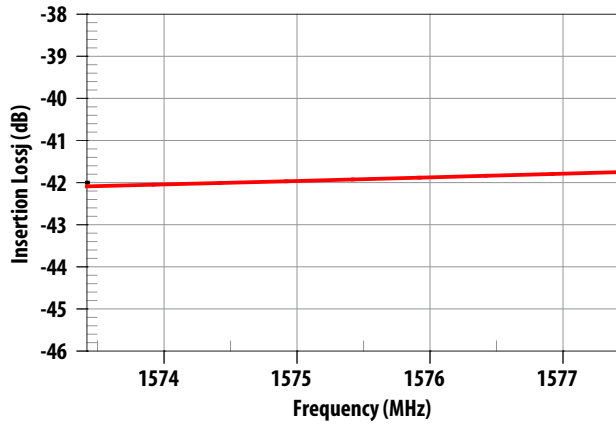

Figure 26. GPS Band Rejection, Cellular Tx-Ant.

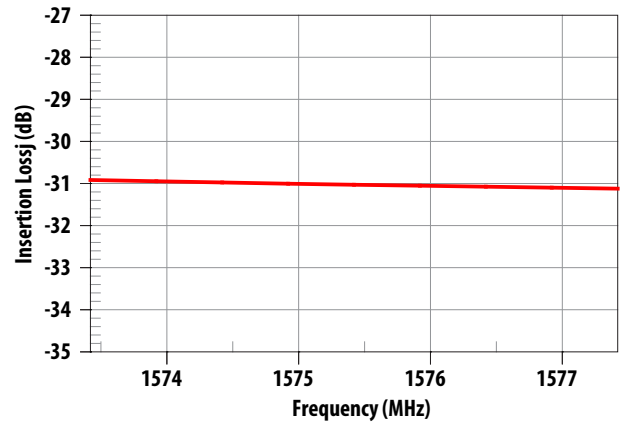
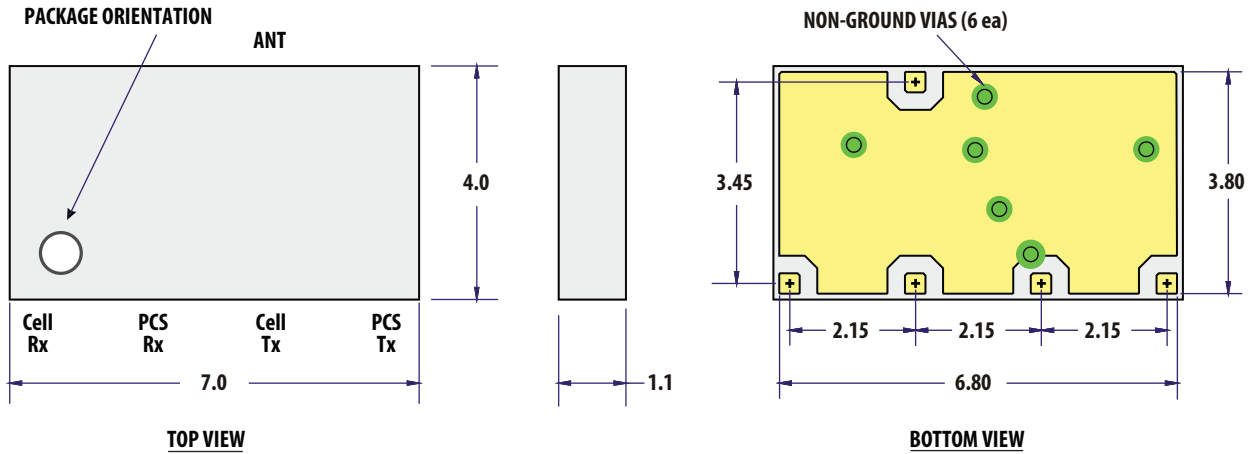

Figure 27. GPS Band Rejection, PCS Tx-Ant.

Notes:

1. Performance shown includes effect of 5.1 nH inductor and 1.0 pF capacitor added to Port 1 (Ant) via simulation as shown in Figure 1.



Notes:

1. Dimensions in mm
2. Tolerance: X.X ± 0.1, X.XX ± 0.05
3. Max OD: 4.1 x 7.1 x 1.2 mm
4. IO pads (5 ea), 0.35 x 0.35, pad to ground plane spacing = 0.03
5. Non-ground vias (6 ea) shown for reference only; covered with 0.30 Ø solder mask
Note: PCB metal on mother board under non-ground vias does not need to be voided
6. Contact areas are gold plated

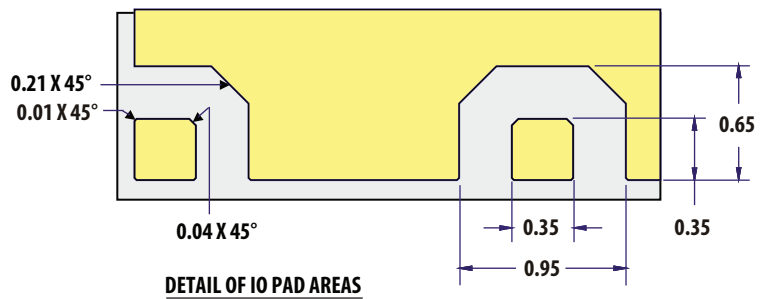

Figure 28. Package Outline Drawing.

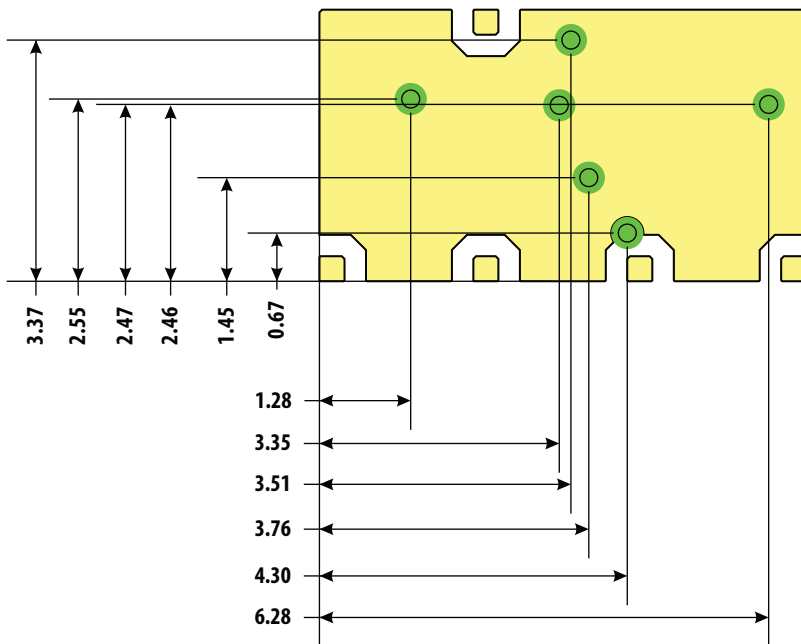
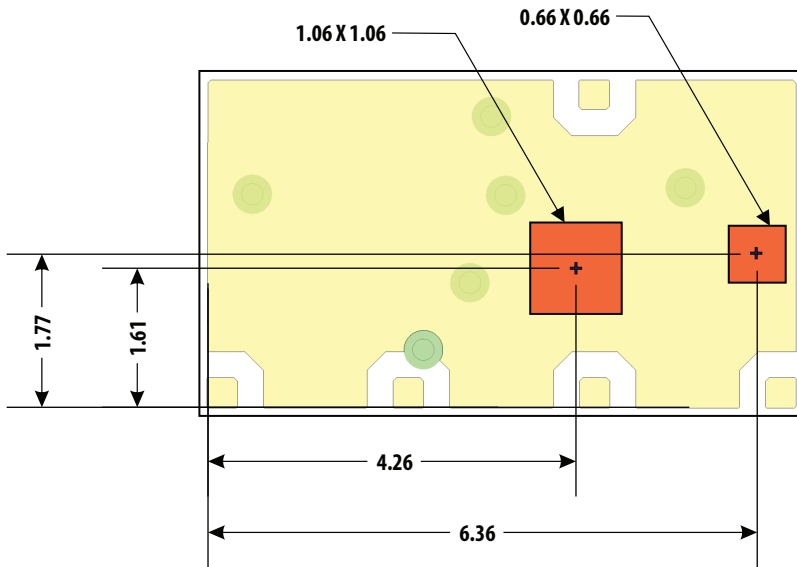

Figure 29. Locations of Non-Ground (Signal) Vias (bottom view).



Notes:

1. Dimensions in mm.
2. Areas shown are location of transmit filters. Adequate heat sinking should be provided for these areas by means of ground/thermal vias. Heat sink areas on the PCB should be larger than the dimensions shown to allow for thermal spreading.
3. Dimensions are referenced to bottom metal pattern. (Top view)

Figure 30. Location of Heat Sink Areas (top view).

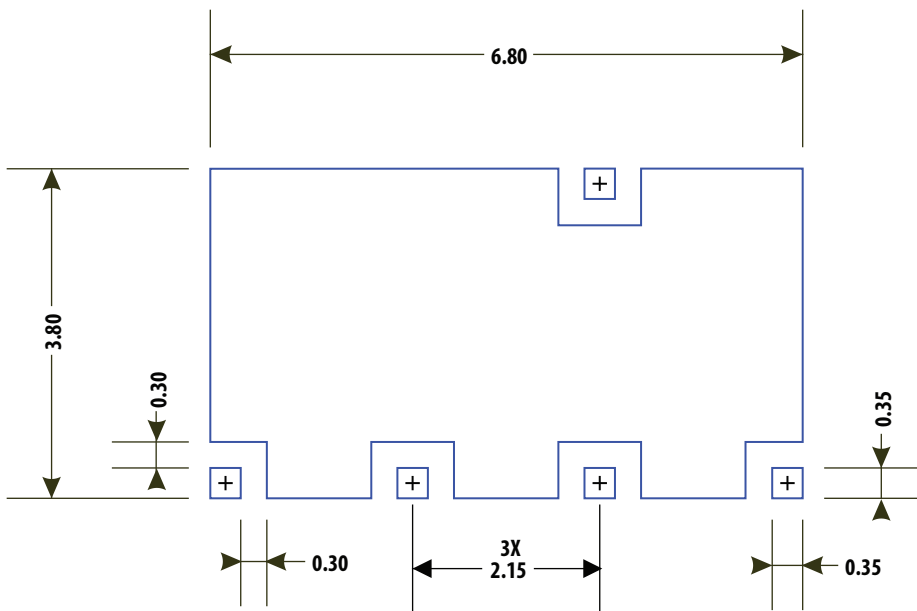

Notes:

1. Dimensions in mm.
2. Pads for I/O terminals and ground area are 1:1 with package bottom metal pattern.

Figure 31. PCB Footprint (top view).

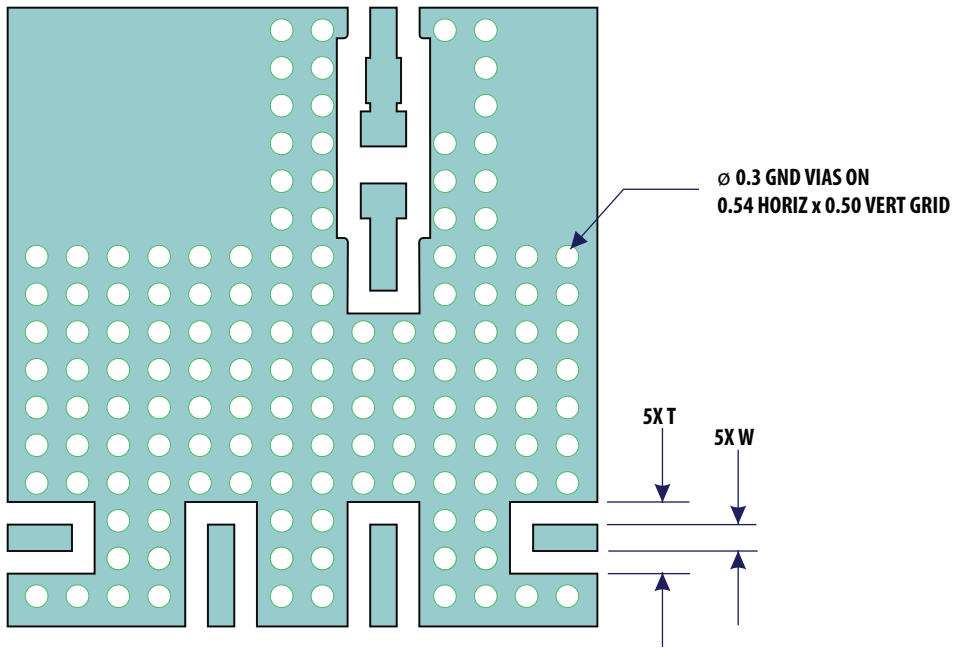

Notes:

1. Dimensions in mm.
2. Dimensions W and T should be adjusted for 50-ohm line impedance (beyond the footprint).
3. Includes provision for series inductor and shunt capacitor (0402 size) at Ant terminal.

Figure 32. Recommended PCB Layout (top view).

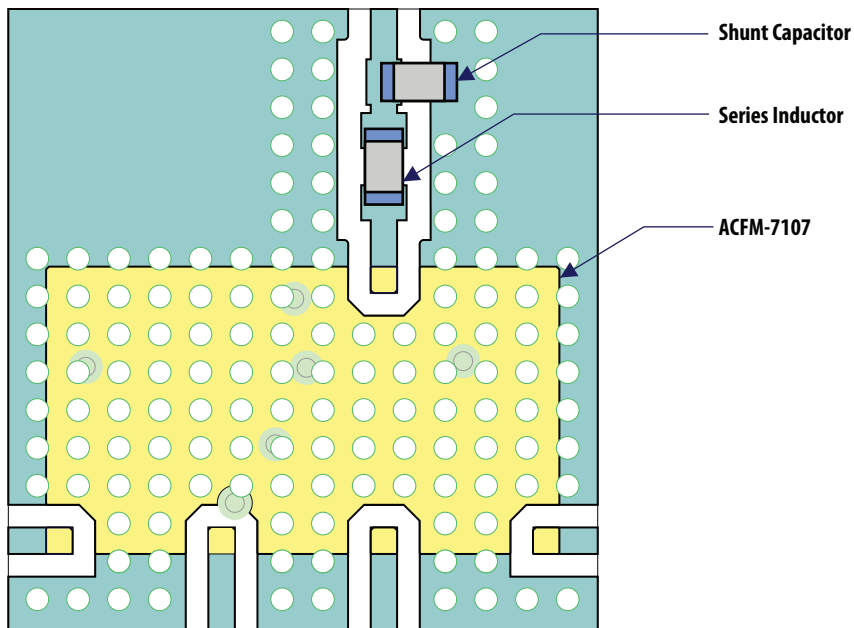

Notes:

1. Antenna matching components shown are 0402 size.

Figure 33. PCB Layout with ACFM-7107 and Ant Matching Components Superposed (top view).

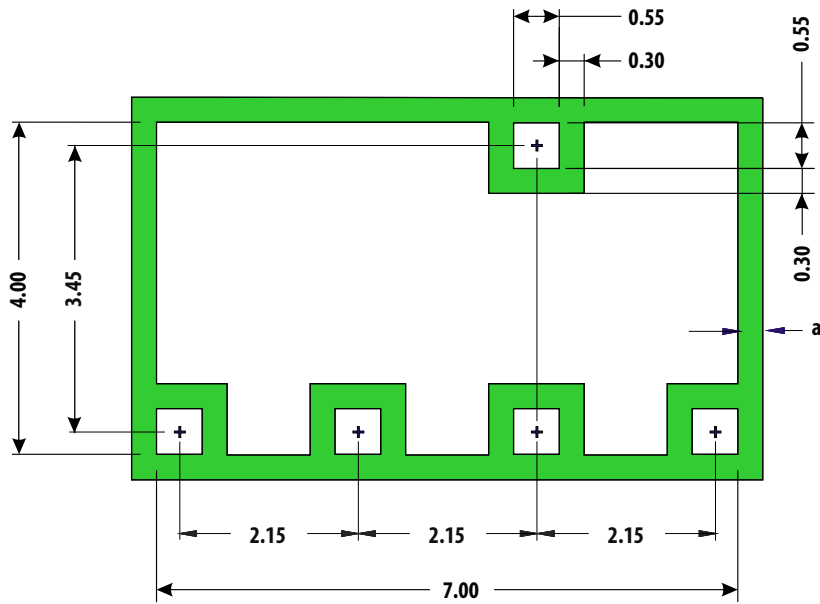

Notes:

1. Dimensions in mm
2. $a \geq 0.3$

Figure 34. Recommended Solder Mask (top view).

The recommended solder mask is a non-solder mask defined (NSMD) pattern for SMT assembly of the ACFM-7107. The 4.00 X 7.00 mm middle opening of the solder mask is centered on the ACFM-7107 PCB location. The openings in the solder mask allow a clearance of 0.10 mm

between the mask and metal patterns on all sides. The advantages of using a NSMD pattern are that it permits slight misalignment of the pattern on the PCB as well as improving solder joint reliability by allowing solder flow around the sides of the metal pads.

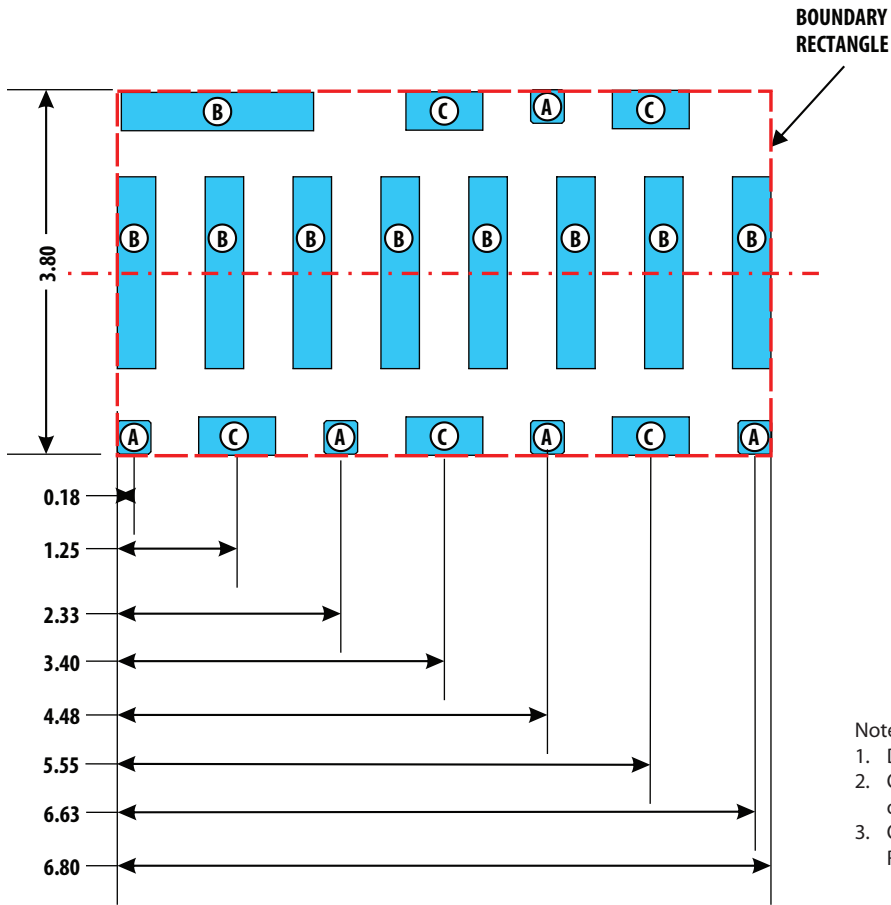

Stencil Opening ID	Qty	Width	Height
A (I/O pad areas)	5	0.35	0.35
B	9	0.40	2.00
C	5	0.80	0.40

Figure 35. Recommended Solder Stencil (top view).

The I/O pad openings ("A") in the recommended solder stencil are the same size as the I/O pad metal patterns on the ACFM-7107.

The stencil pattern for the large ground pad area is divided into smaller openings ("B" through "C") for the purpose of reducing the volume of solder paste. The use of smaller apertures reduces risk of solder voiding as well as preventing the device from "floating" during reflow.

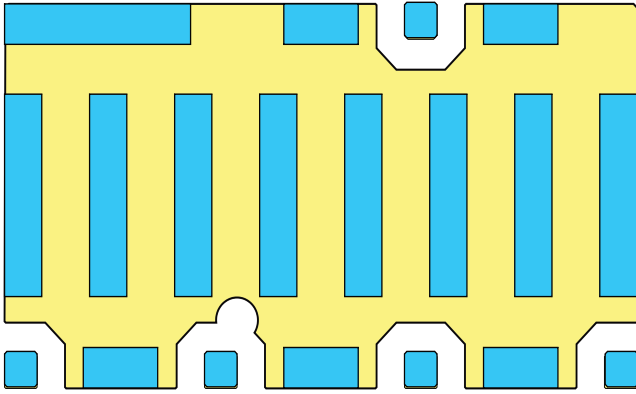

Figure 36. Solder Stencil Superposed on ACFM-7107 Bottom Metal Pattern. (top view)

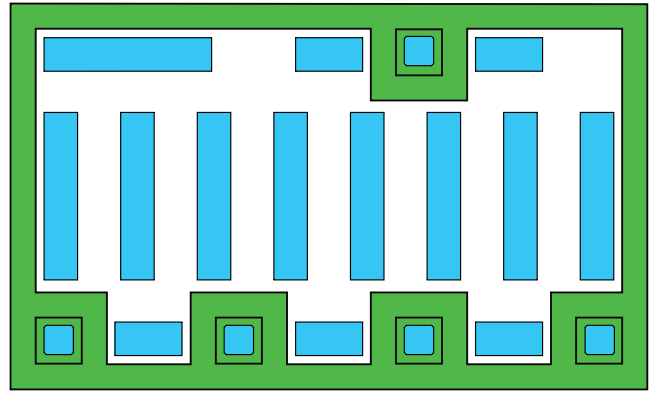

Figure 37. Solder Mask Superposed on Solder Stencil. (top view)

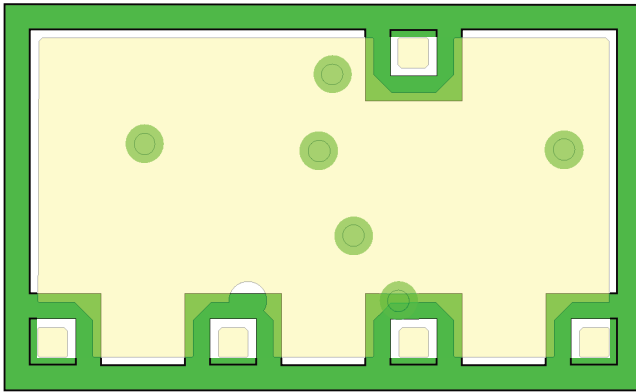

Figure 38. Solder Mask Superposed on ACFM-7107 Bottom Metal Pattern. (top view)

Package Moisture Sensitivity

Feature	Test Method	Performance
Moisture Sensitivity Level (MSL) at 260°C	J-STD-20C	Level 3

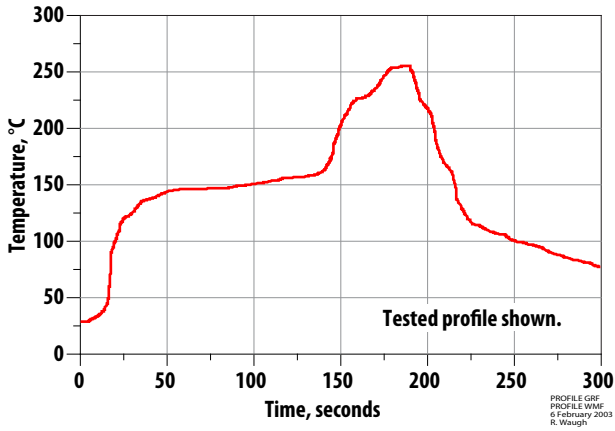

Figure 39. Verified SMT Solder Profile.

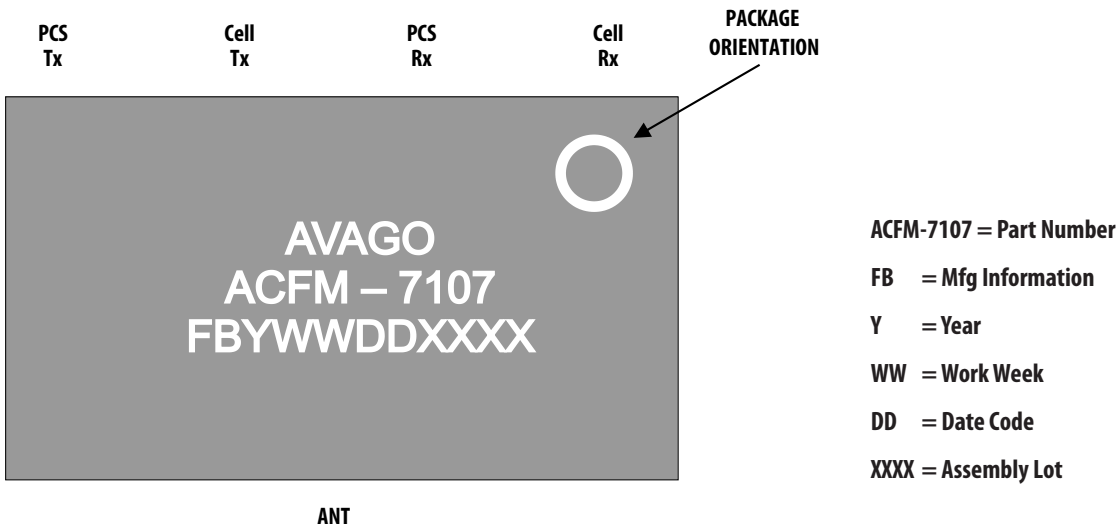

Figure 40. Package Marking

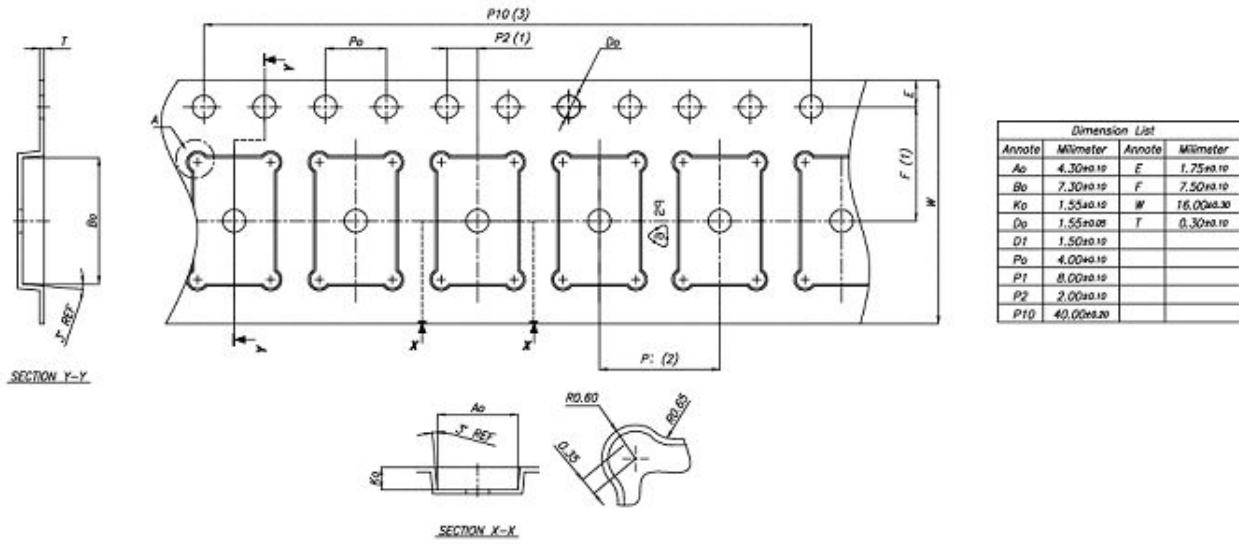

Figure 41. SMT Tape Packing

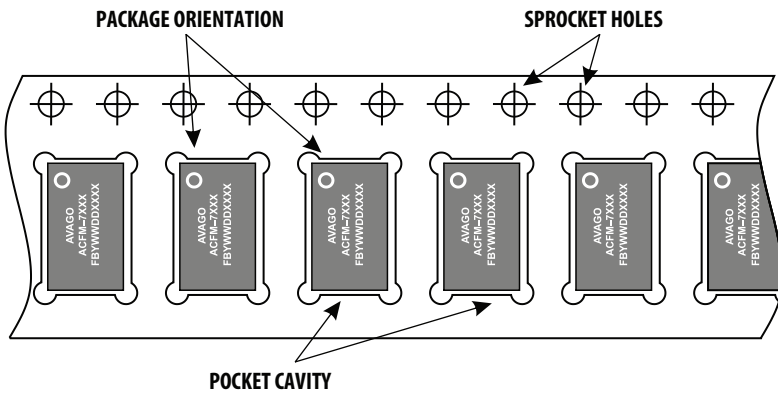
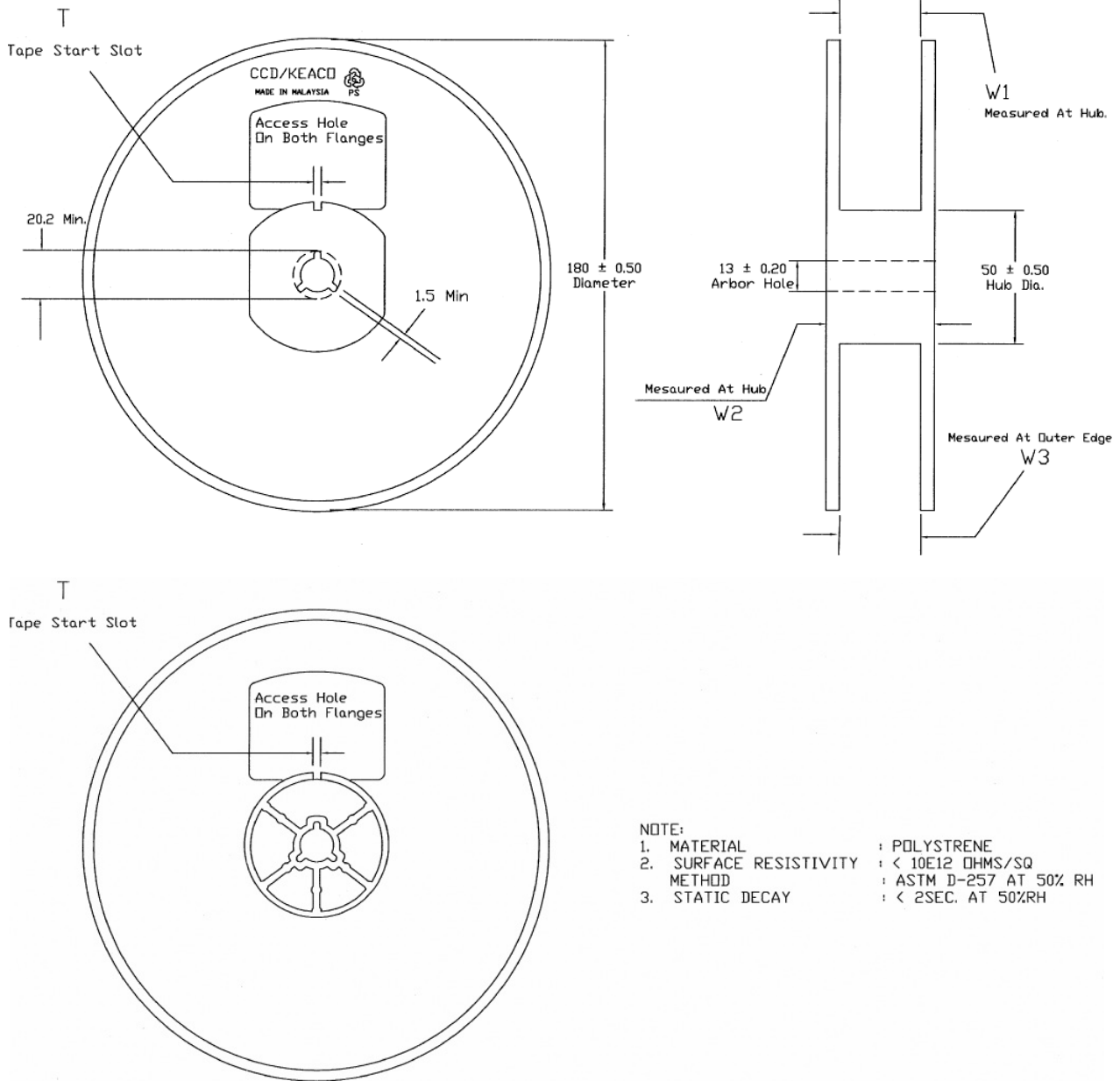

Figure 42. Orientation in Tape



NOTE:
 1. MATERIAL : POLYSTRENE
 2. SURFACE RESISTIVITY : < 10E12 OHMS/SQ
 METHOD : ASTM D-257 AT 50% RH
 3. STATIC DECAY : < 2SEC. AT 50%RH

Figure 43. Reel Drawing

Ordering Information

Part Number	No. of Devices	Container
ACFM-7107-BLK	25	Anti-static Bag
ACFM-7107-TR1	1000	7-inch Reel

For product information and a complete list of distributors, please go to our web site: www.avagotech.com

Avago, Avago Technologies, and the A logo are trademarks of Avago Technologies in the United States and other countries.
 Data subject to change. Copyright © 2005-2009 Avago Technologies. All rights reserved.
 AV02-1904EN - June 24, 2009

AVAGO
 TECHNOLOGIES