

### IGBT MODULE (U series) 1200V / 50A / PIM



#### ■ Features

- Low  $V_{CE(sat)}$
- Compact Package
- P.C. Board Mount Module
- Converter Diode Bridge Dynamic Brake Circuit

#### ■ Applications

- Inverter for Motoe Drive
- AC and DC Servo Drive Amplifier
- Uninterruptible Power Supply

#### ■ Maximum ratings and characteristics

● Absolute maximum ratings ( $T_c=25^\circ\text{C}$  unless otherwise specified)

Item	Symbol	Condition	Rating	Unit		
Inverter	Collector-Emitter voltage	$V_{CES}$	1200	V		
	Gate-Emitter voltage	$V_{GES}$	$\pm 20$	V		
	Collector current	$I_c$	Continuous	$T_c=25^\circ\text{C}$	50	A
				$T_c=80^\circ\text{C}$	35	
		$I_{CP}$	1ms	$T_c=25^\circ\text{C}$	100	
				$T_c=80^\circ\text{C}$	70	
$-I_c$			50			
$-I_c$ pulse	1ms		100			
Collector power dissipation	$P_c$	1 device	205	W		
Brake	Collector-Emitter voltage	$V_{CES}$	1200	V		
	Gate-Emitter voltage	$V_{GES}$	$\pm 20$	V		
	Collector current	$I_c$	Continuous	$T_c=25^\circ\text{C}$	35	A
				$T_c=80^\circ\text{C}$	25	
		$I_{CP}$	1ms	$T_c=25^\circ\text{C}$	70	
				$T_c=80^\circ\text{C}$	50	
Collector power dissipation	$P_c$	1 device	160	W		
Repetitive peak reverse voltage	$V_{RRM}$		1200	V		
Converter	Repetitive peak reverse voltage	$V_{RRM}$	1600	V		
	Average output current	$I_o$	50Hz/60Hz sine wave	50	A	
	Surge current (Non-Repetitive)	$I_{FSM}$	$T_j=150^\circ\text{C}$ , 10ms	520	A	
	$I^2t$ (Non-Repetitive)	$I^2t$	half sine wave	1352	$\text{A}^2\text{s}$	
Operating junction temperature	$T_j$		+150	$^\circ\text{C}$		
Storage temperature	$T_{stg}$		-40 to +125	$^\circ\text{C}$		
Isolation voltage	between terminal and copper base *2	$V_{iso}$	AC : 1 minute	AC 2500	V	
	between thermistor and others *3			AC 2500	V	
Mounting screw torque			3.5 *1	N·m		

\*1 Recommendable value : 2.5 to 3.5 N·m (M5)

\*2 All terminals should be connected together when isolation test will be done.

\*3 Two thermistor terminals should be connected together, each other terminals should be connected together and shorted to base plate when isolation test will be done.

## ● Electrical characteristics (T<sub>j</sub>=25°C unless otherwise specified)

Item	Symbol	Condition	Characteristics			Unit		
			Min.	Typ.	Max.			
Inverter	Zero gate voltage collector current	ICES	V <sub>CE</sub> =1200V, V <sub>GE</sub> =0V		-	1.0	mA	
	Gate-Emitter leakage current	IGES	V <sub>CE</sub> =0V, V <sub>GE</sub> =±20V		-	200	nA	
	Gate-Emitter threshold voltage	V <sub>GE(th)</sub>	V <sub>CE</sub> =20V, I <sub>C</sub> =50mA		4.5	6.5	8.5	V
	Collector-Emitter saturation voltage	V <sub>CE(sat)</sub> (terminal)	V <sub>GE</sub> =15V I <sub>C</sub> =50A	T <sub>J</sub> =25°C	-	2.25	2.65	V
				T <sub>J</sub> =125°C	-	2.60	-	
		V <sub>CE(sat)</sub> (chip)		T <sub>J</sub> =25°C	-	2.00	2.40	
				T <sub>J</sub> =125°C	-	2.35	-	
	Input capacitance	C <sub>ies</sub>	V <sub>GE</sub> =0V, V <sub>CE</sub> =10V, f=1MHz		-	4	-	nF
	Turn-on time	t <sub>on</sub>	V <sub>CC</sub> =600V		-	0.53	1.20	μs
		t <sub>r</sub>	I <sub>C</sub> =50A		-	0.43	0.60	
		t <sub>r(i)</sub>	V <sub>GE</sub> =±15V		-	0.03	-	
	Turn-off time	t <sub>off</sub>	R <sub>G</sub> = 33 Ω		-	0.37	1.00	μs
t <sub>f</sub>				-	0.07	0.30		
Forward on voltage	V <sub>F</sub> (terminal)	V <sub>GE</sub> = 0 V I <sub>F</sub> =50A	T <sub>J</sub> =25°C	-	2.05	2.35	V	
			T <sub>J</sub> =125°C	-	2.20	-		
	V <sub>F</sub> (chip)		T <sub>J</sub> =25°C	-	1.80	2.10		
			T <sub>J</sub> =125°C	-	1.95	-		
Reverse recovery time	t <sub>rr</sub>	I <sub>F</sub> =50A		-	-	0.35	μs	
Brake	Zero gate voltage collector current	ICES	V <sub>CE</sub> =1200V, V <sub>GE</sub> =0V		-	1.0	mA	
	Gate-Emitter leakage current	IGES	V <sub>CE</sub> =0V, V <sub>GE</sub> =±20V		-	200	nA	
	Collector-Emitter saturation voltage	V <sub>CE(sat)</sub> (terminal)	I <sub>C</sub> =35A V <sub>GE</sub> =15V	T <sub>J</sub> =25°C	-	2.20	2.65	V
				T <sub>J</sub> =125°C	-	2.55	-	
		V <sub>CE(sat)</sub> (chip)		T <sub>J</sub> =25°C	-	1.95	2.40	
				T <sub>J</sub> =125°C	-	2.30	-	
	Turn-on time	t <sub>on</sub>	V <sub>CC</sub> =600V		-	0.53	1.20	μs
		t <sub>r</sub>	I <sub>C</sub> =35A		-	0.43	0.60	
	Turn-off time	t <sub>off</sub>	V <sub>GE</sub> =±15V		-	0.37	1.00	μs
		t <sub>f</sub>	R <sub>G</sub> = 43 Ω		-	0.07	0.30	
	Reverse current	I <sub>RRM</sub>	V <sub>R</sub> =1200V		-	-	1.0	mA
	Converter	Forward on voltage	V <sub>FM</sub>	I <sub>F</sub> =50A	terminal	-	1.20	1.50
V <sub>GE</sub> =0V				chip	-	1.10	-	
Reverse current	I <sub>RRM</sub>	V <sub>R</sub> =1600V		-	-	1.0	mA	
Thermistor	Resistance	R	T=25°C	-	5000	-	Ω	
			T=100°C	465	495	520		
B value	B	T=25/50°C		3305	3375	3450	K	

## ● Thermal resistance Characteristics

Item	Symbol	Condition	Characteristics			Unit
			Min.	Typ.	Max.	
Thermal resistance ( 1 device )	R <sub>th(j-c)</sub>	Inverter IGBT	-	-	0.60	°C/W
		Inverter FWD	-	-	0.88	
		Brake IGBT	-	-	0.76	
		Converter Diode	-	-	0.50	
Contact thermal resistance *	R <sub>th(c-f)</sub>	With thermal compound	-	0.05	-	

\* This is the value which is defined mounting on the additional cooling fin with thermal compound

## ■ Equivalent Circuit Schematic

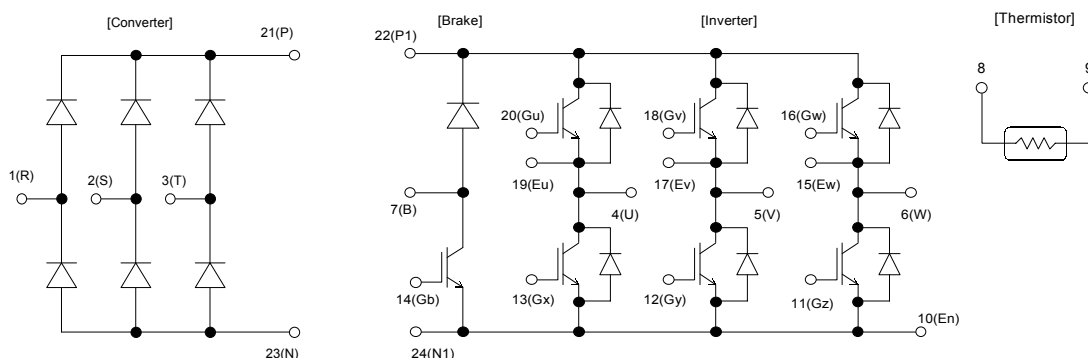

■ Characteristics (Representative)

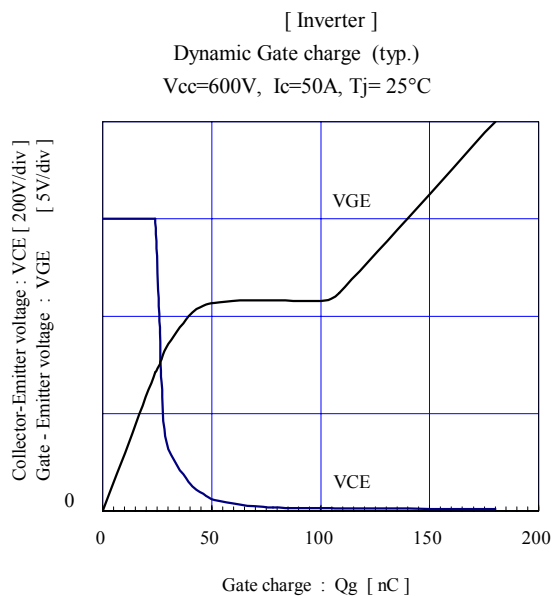
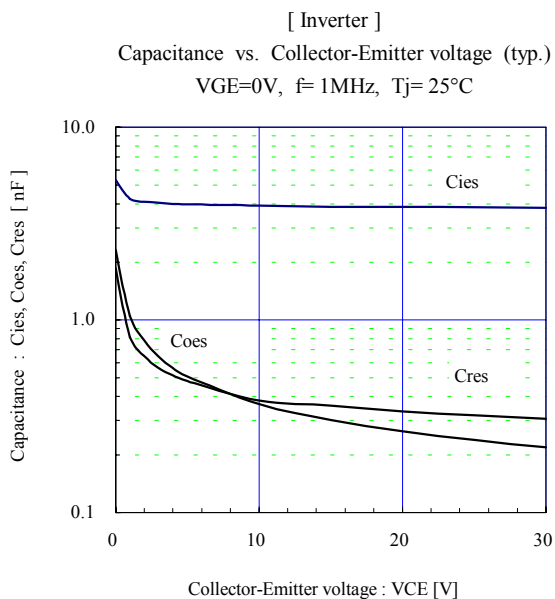
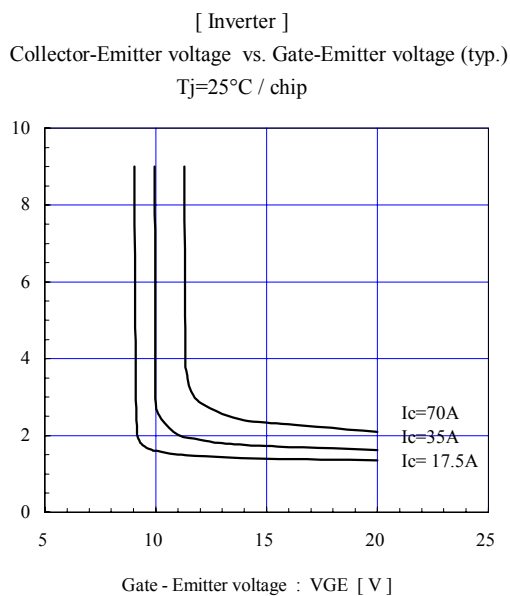
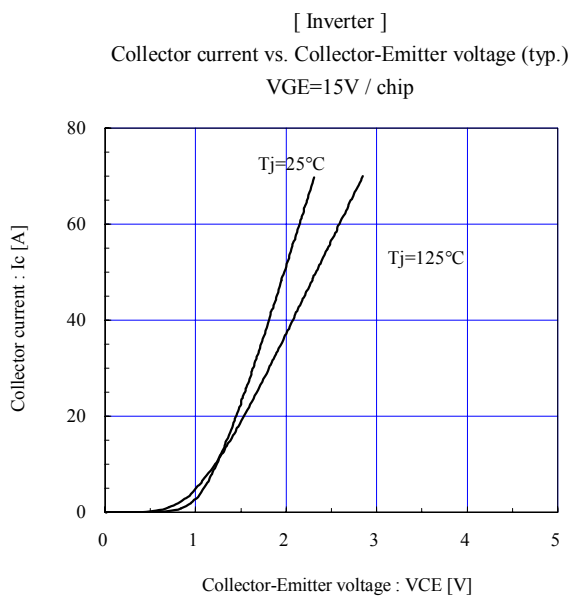
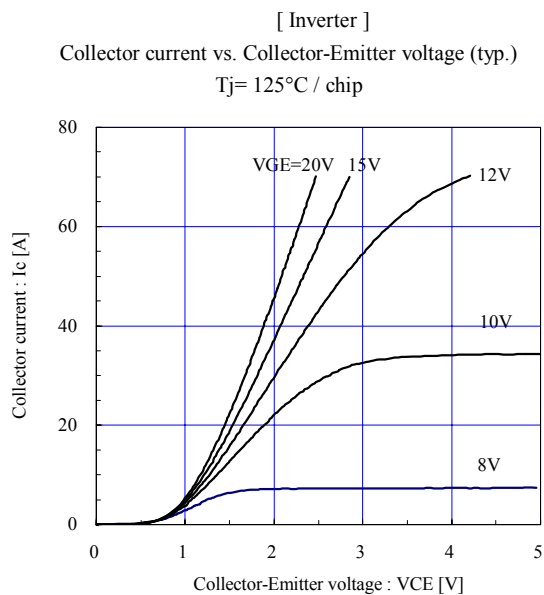
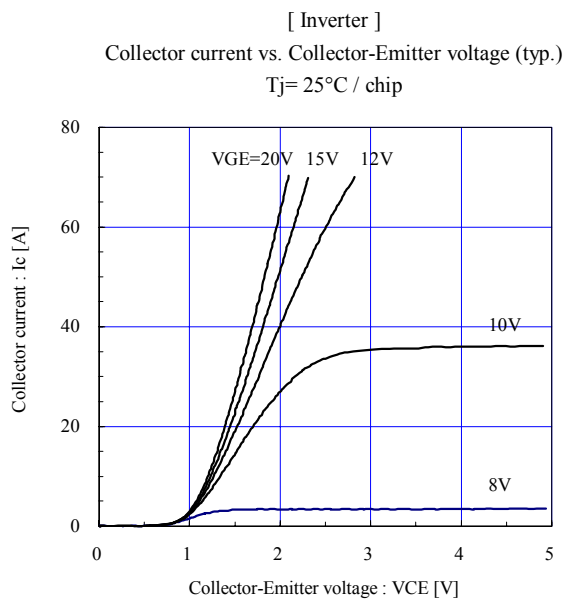

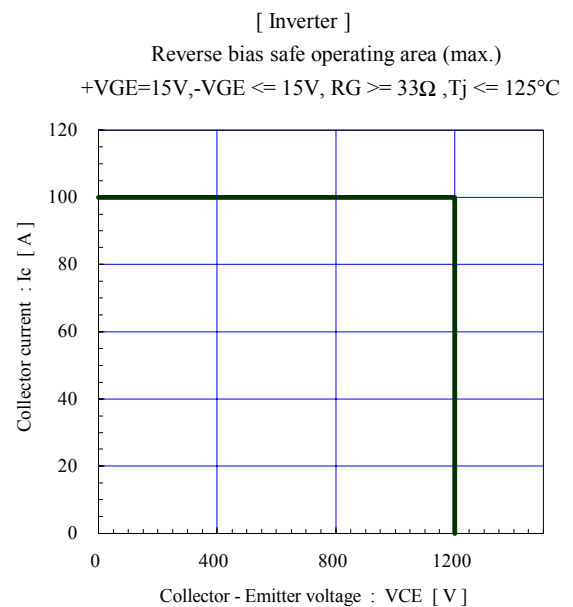
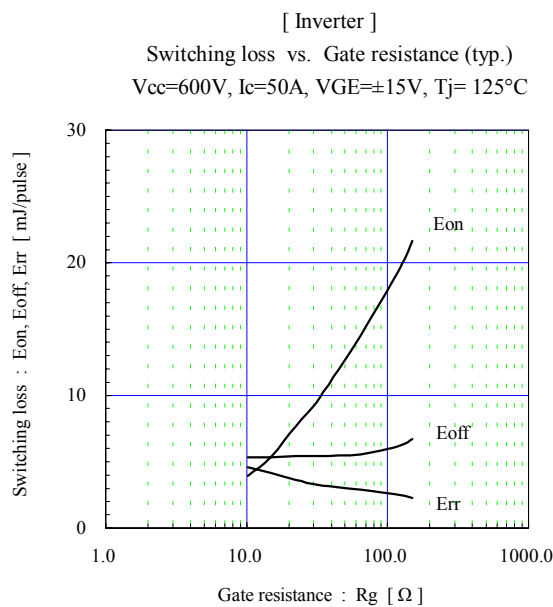
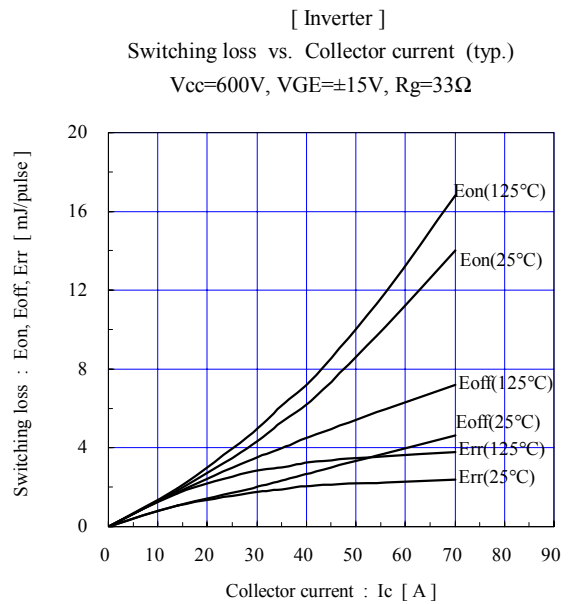
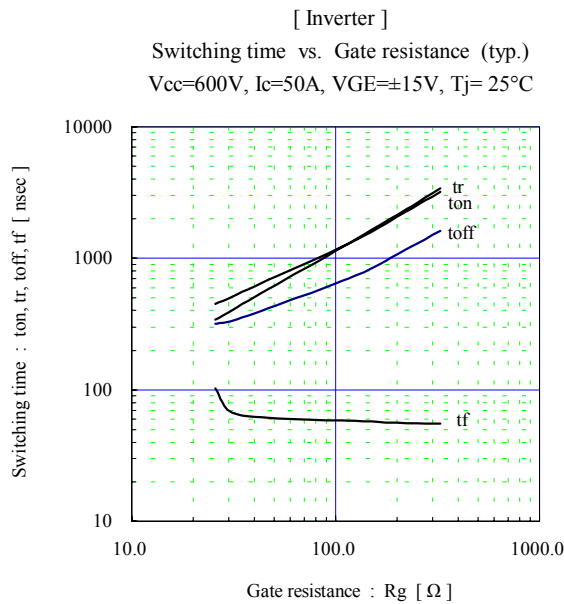
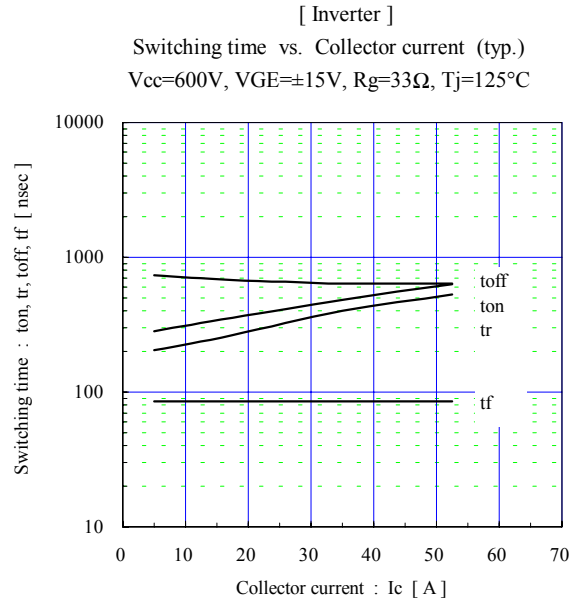
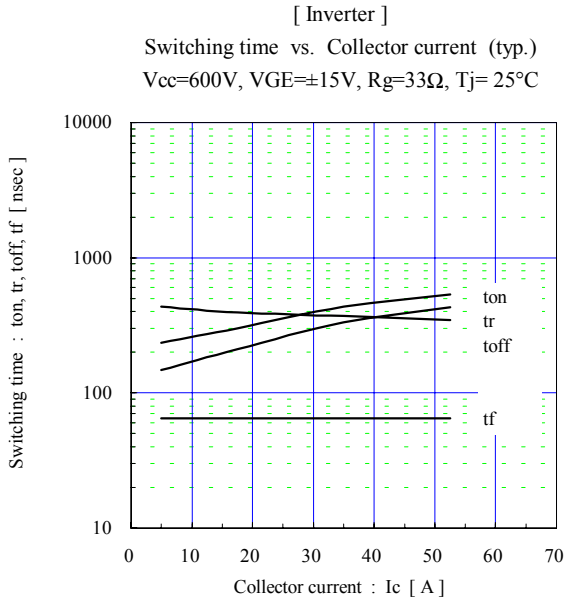

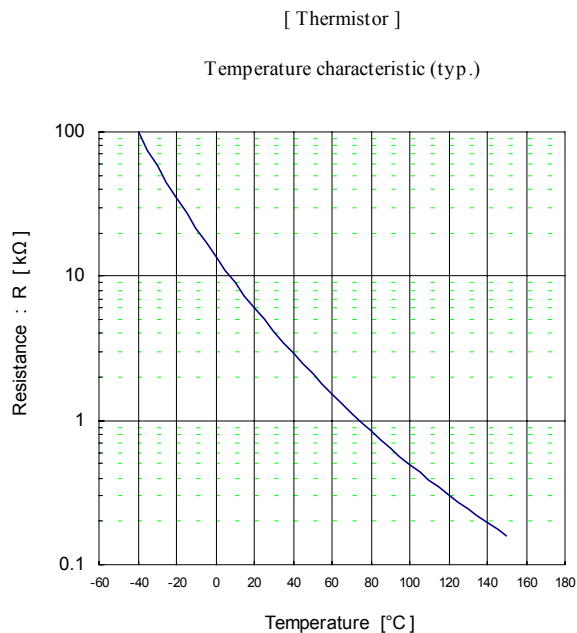
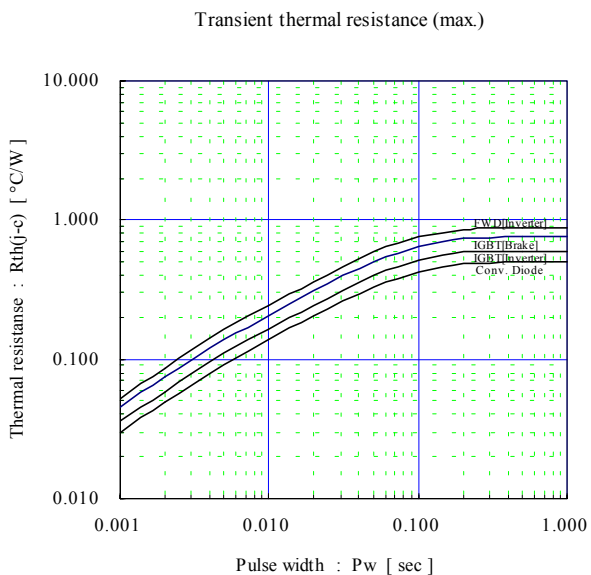
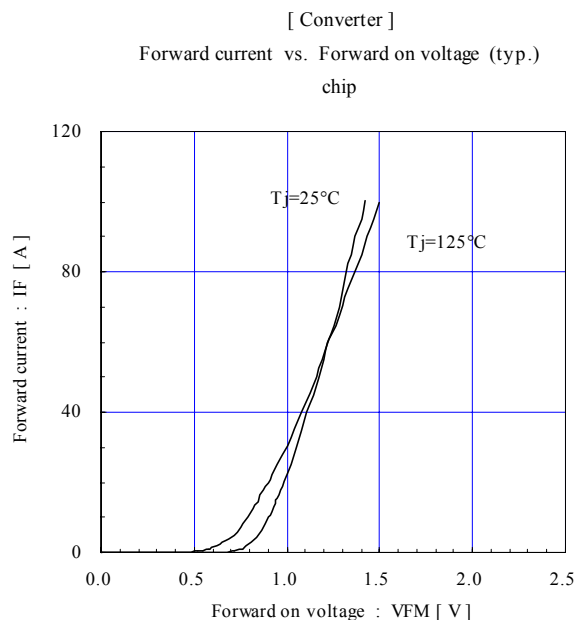
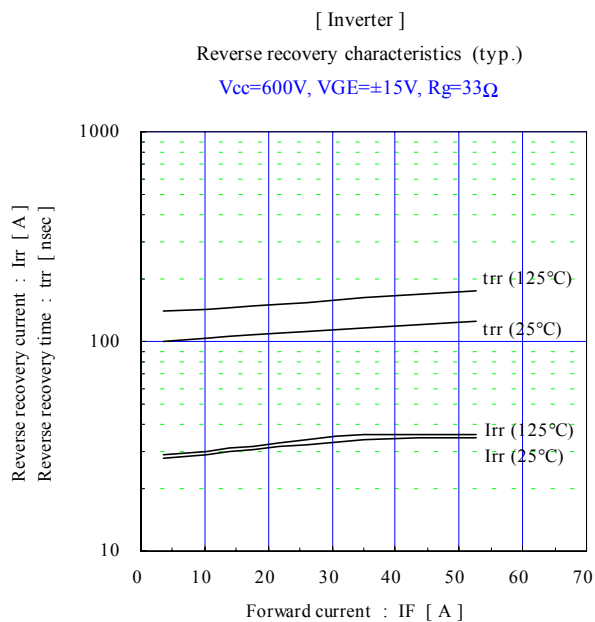
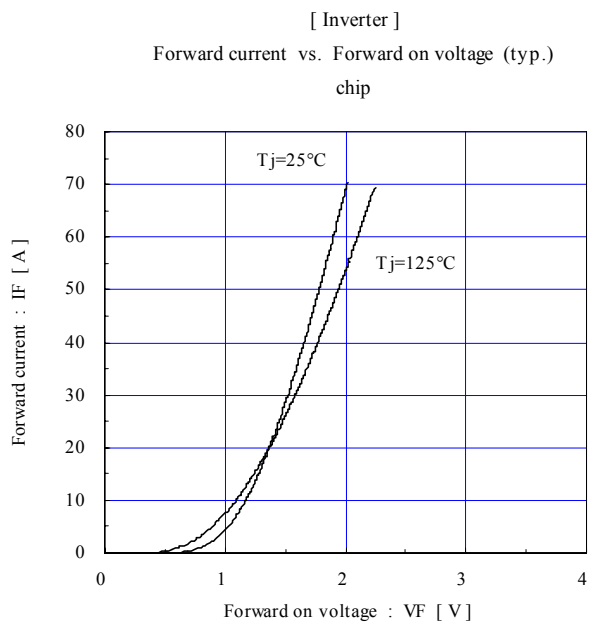

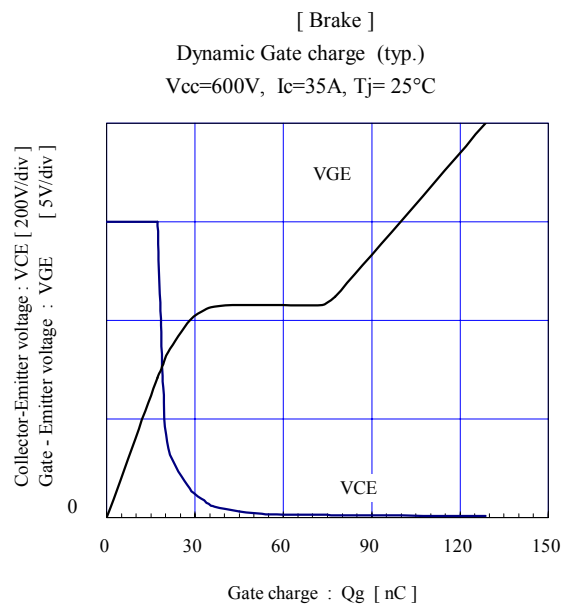
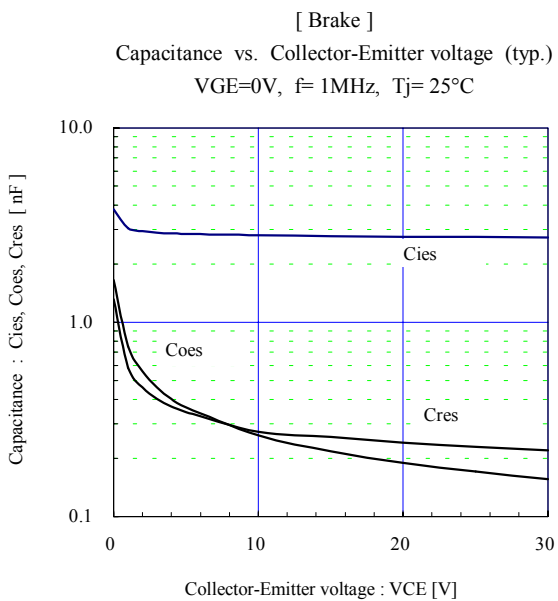
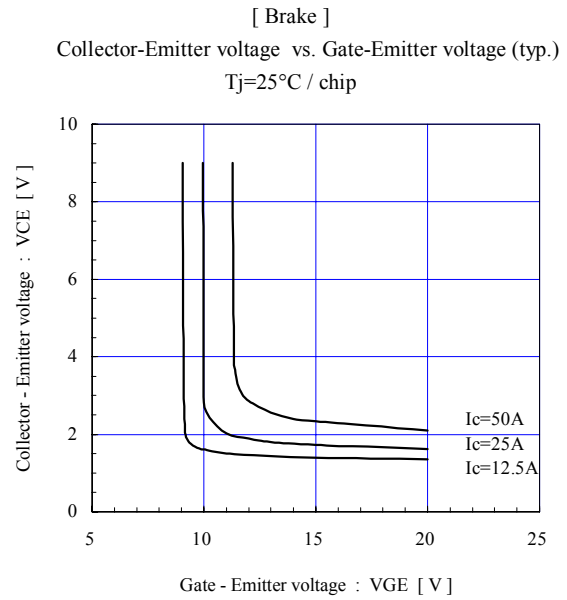
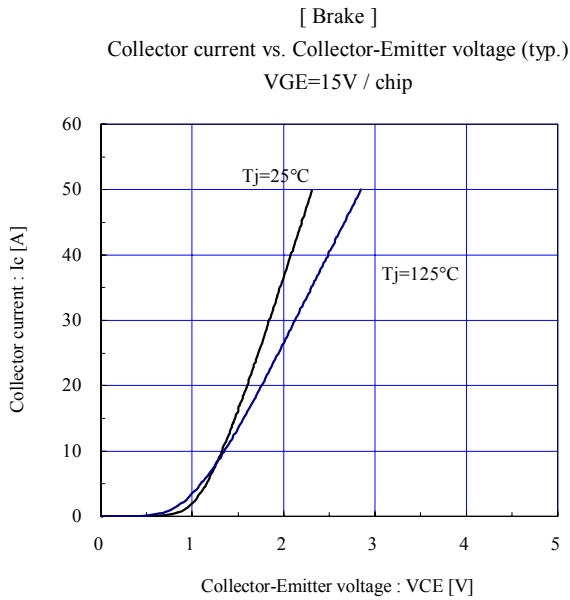
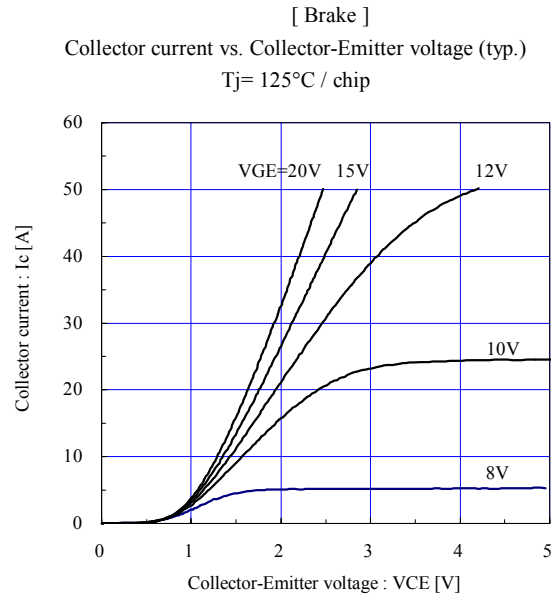
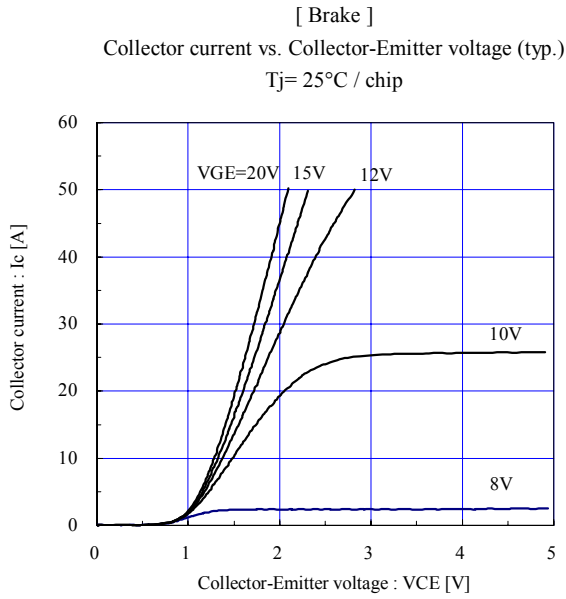

■ Outline Drawings, mm

