

IGBT MODULE (N-series)

1200V / 40A (7 in one-package)

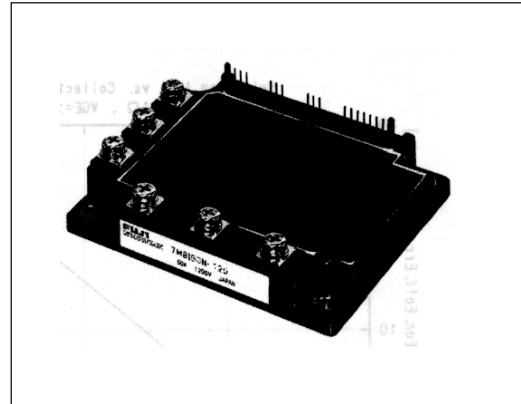

■ Features

- High Speed Switching
- Voltage Drive
- Low Inductance Module Structure
- Dynamic Brake Circuit

■ Applications

- Inverter for Motor Drive
- AC and DC Servo Drive Amplifier
- Uninterruptible Power Supply

■ Maximum ratings and characteristics

● Absolute maximum ratings (Tc=25°C unless without specified)

Item	Symbol	Condition	Rating	Unit	
Inverter(IGBT)	Collector-Emitter voltage	V _{CEs}	1200	V	
	Gate-Emitter voltage	V _{GEs}	±20	V	
	Collector current	DC	I _c	40	A
		1ms	I _{cP}	80	A
		DC	-I _c	40	A
Collector power dissipation 1 device	P _c		320	W	
Brake(IGBT+FWD)	Collector-Emitter voltage	V _{CEs}	1200	V	
	Gate-Emitter voltage	V _{GEs}	±20	V	
	Collector current	DC	I _c	15	A
		1ms	I _{cP}	30	A
	Collector power dissipation 1 device	P _c		120	W
	Repetitive peak reverse voltage	V _{RRM}		1200	V
	Average forward current	I _{F(AV)}		1	A
Surge current	I _{FSM}	10ms	50	A	
Operating junction temperature	T _j		+150	°C	
Storage temperature	T _{stg}		-40 to +125	°C	
Isolation voltage	V _{iso}	AC : 1 minute	AC 2500	V	
Mounting screw torque	Mounting*1		3.5	N·m	
	Terminal*1		3.5		

*1 Recommendable value : 2.5 to 3.5 N·m

● Electrical characteristics (Tj=25°C unless without specified)

Item	Symbol	Condition	Characteristics			Unit		
			Min.	Typ.	Max.			
Inverter (IGBT)	Zero gate voltage collector current	ICES	Tj=25°C, VCE=1200V, VGE=0V			3.0	mA	
	Gate-Emitter leakage current	IGES	VCE=0V, VGE=±20V			15	µA	
	Gate-Emitter threshold voltage	VGE(th)	VCE=20V, IC=40mA			4.5	7.5	V
	Collector-Emitter saturation voltage	VCE(sat)	VGE=15V, IC=40A				3.3	V
	Collector-Emitter voltage	-VCE	-IC=40A				3.0	V
	Input capacitance	Cies	VGE=0V, VCE=10V, f=1MHz				6200	pF
	Switching time	ton	VCC=600V				1.2	µs
		toff	IC=40A				1.5	µs
tr		VGE=±15V, RG=24 ohm				0.5	µs	
Reverse recovery time of FRD	trr	IF=40A, VGE=-10V, -di/dt=120A/µs				350	ns	
Brake (IGBT)	Zero gate voltage collector current	ICES	VCE=1200V, VGE=0V				1.0	mA
	Gate-Emitter leakage current	IGES	VCE=0V, VGE=±20V				100	nA
	Collector-Emitter saturation voltage	VCE(sat)	IC=15A, VGE=15V				3.3	V
	Switching time	ton	VCC=600V				1.2	µs
		toff	IC=15A				1.5	µs
tr		VGE=±15V, RG=82ohm				0.5	µs	
Brake (FWD)	Reverse current	IRRM	VR=VRRM				1.0	mA
	Reverse recovery time	trr					600	ns

● Thermal Characteristics

Item	Symbol	Condition	Characteristics			Unit
			Min.	Typ.	Max.	
Thermal resistance (1 device)	Rth(j-c)	Inverter IGBT			0.39	°C/W
		Inverter FRD			0.85	
		Brake IGBT			1.04	
Contact thermal resistance *	Rth(c-f)	With thermal compound		0.05		

* This is the value which is defined mounting on the additional cooling fin with thermal compound

■ Equivalent Circuit Schematic

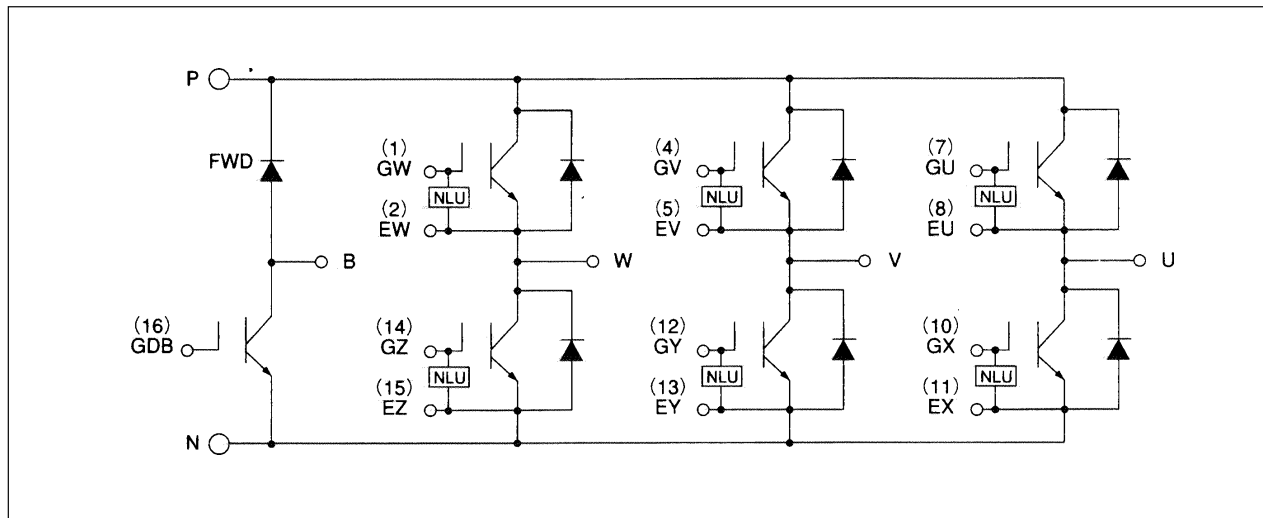

■ Characteristics (Representative)

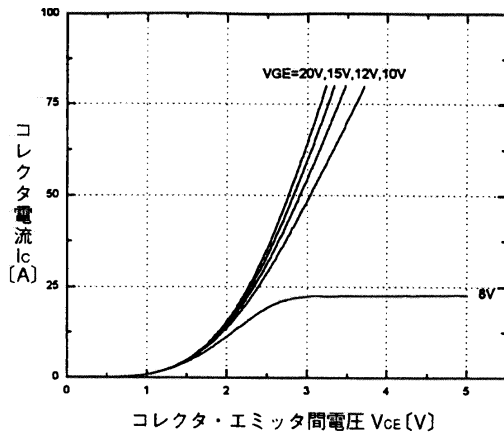

コレクタ電流-コレクタ・エミッタ間電圧特性 ($T_j=25^\circ\text{C}$) <INV部>
Collector current vs. Collector-Emmitter voltage <INV>

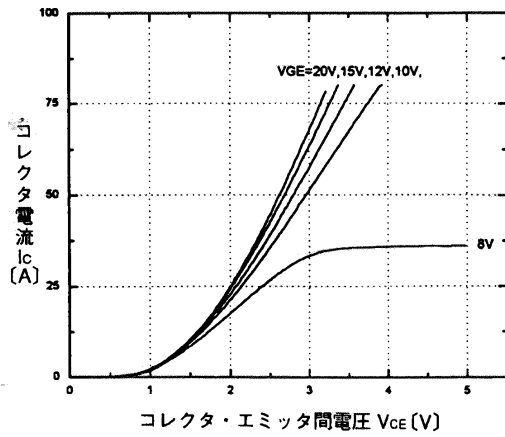

コレクタ電流-コレクタ・エミッタ間電圧特性 ($T_j=125^\circ\text{C}$) <INV部>
Collector current vs. Collector-Emmitter voltage <INV>

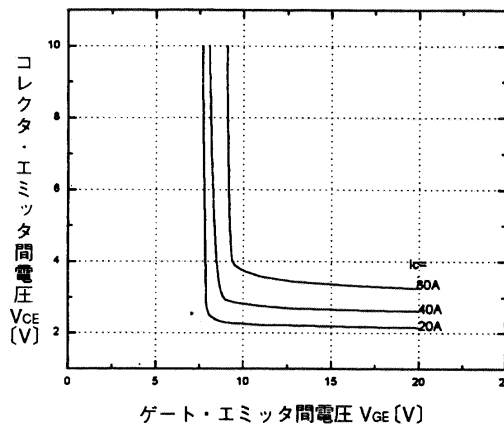

コレクタ・エミッタ間電圧-ゲート・エミッタ間電圧特性 ($T_j=25^\circ\text{C}$) <INV部>
Collector-Emmitter voltage vs. Gate-Emmitter voltage <INV>

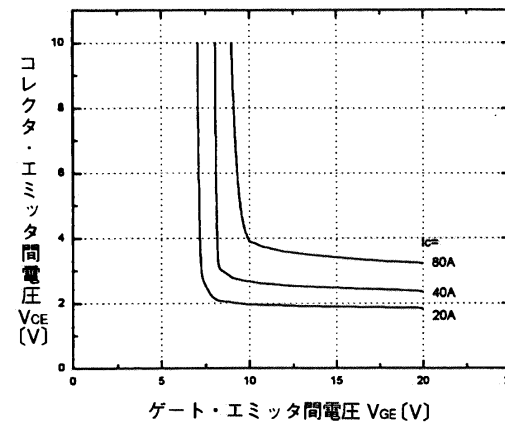

コレクタ・エミッタ間電圧-ゲート・エミッタ間電圧特性 ($T_j=125^\circ\text{C}$) <INV部>
Collector-Emmitter voltage vs. Gate-Emmitter voltage <INV>

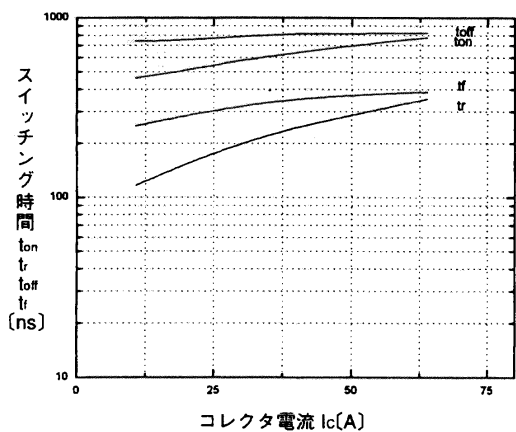

スイッチング時間-コレクタ電流特性 ($T_j=25^\circ\text{C}$) <INV部>
Switching time vs. Collector current <INV>

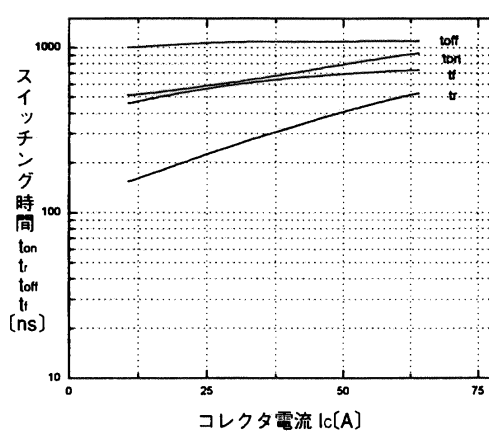

スイッチング時間-コレクタ電流特性 ($T_j=125^\circ\text{C}$) <INV部>
Switching time vs. Collector current <INV>

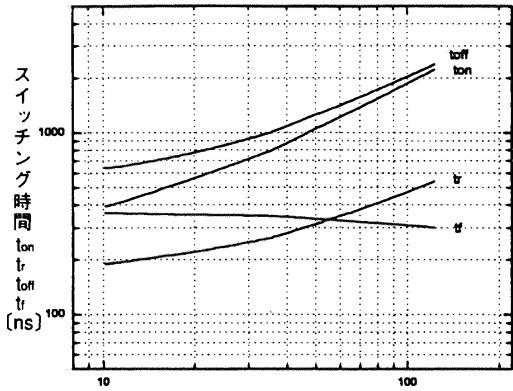

ゲート抵抗 R_G (Ω)
 スイッチング時間-ゲート抵抗特性 ($T_j=25^\circ\text{C}$) <INV部>
 Switching time vs. Gate resistance <INV>

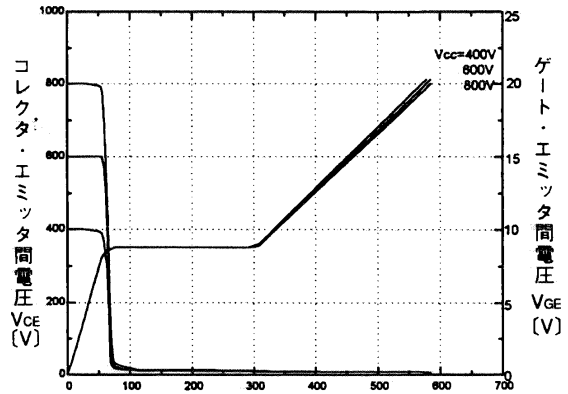

充電電荷量 Q_g (nC)
 ダイナミック入力特性 ($T_j=25^\circ\text{C}$) <INV部>
 Dynamic input characteristic <INV>

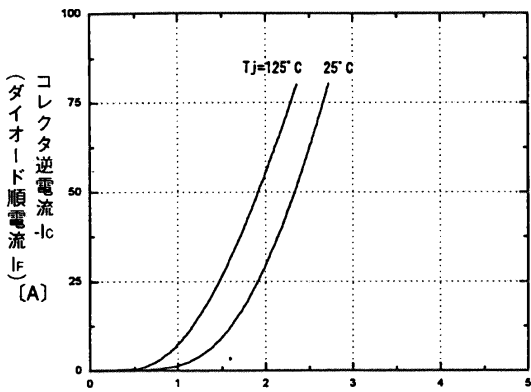

エミッタ・コレクタ間電圧 V_{ECF} (V)
 (ダイオード順電圧 V_F)
 高速フリーホイールダイオード順電圧特性 <INV部>
 Forward voltage of free wheel diode <INV>

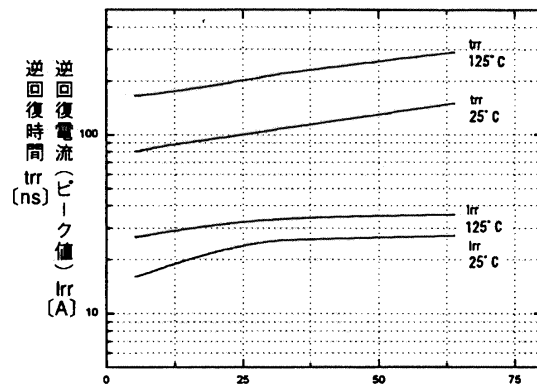

順電圧 V_F (V)
 T_{rr} , I_{rr} - I_F 特性 <INV部>
 T_{rr} , I_{rr} - I_F <INV>

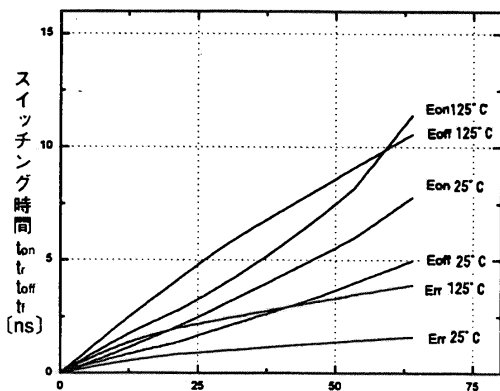

コレクタ電流 I_c (A)
 スイッチング損失-コレクタ電流特性 <INV部>
 Switching loss vs. Collector current <INV>

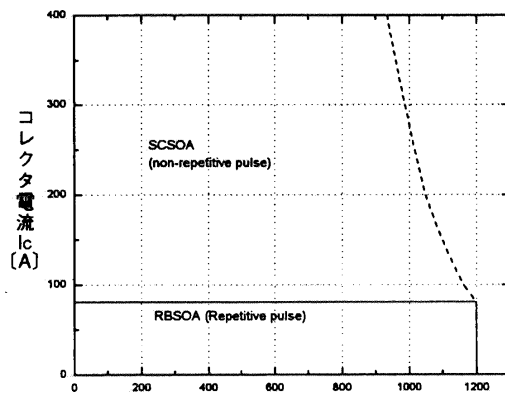

コレクタ・エミッタ間電圧 V_{CE} (V)
 安全動作領域(逆バイアス) ($T_j \leq 125^\circ\text{C}$) <INV部>
 Reverse biased safe operating area <INV>

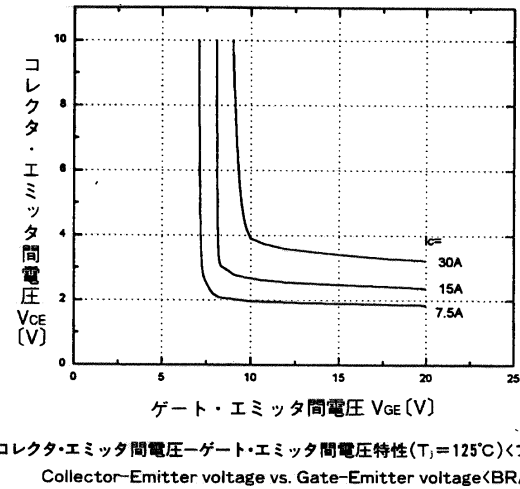
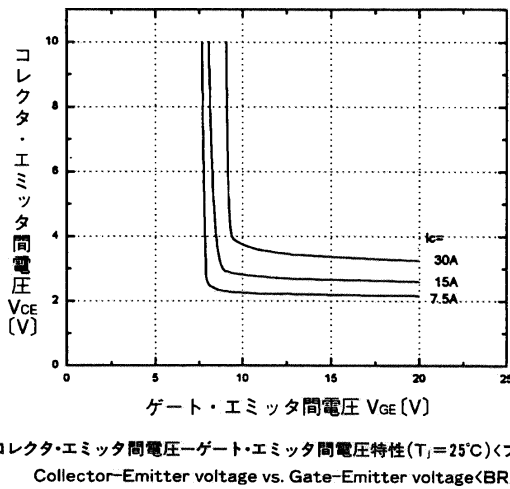
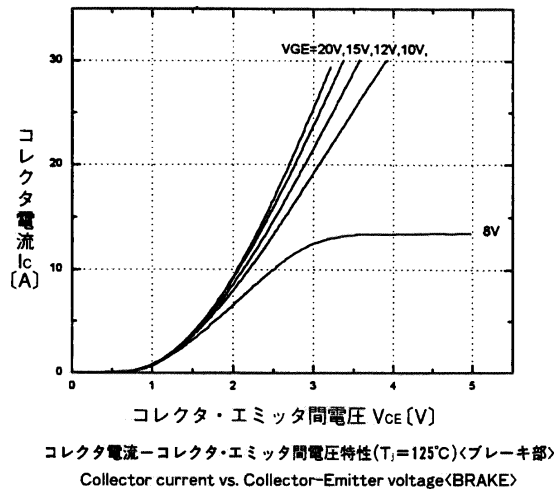
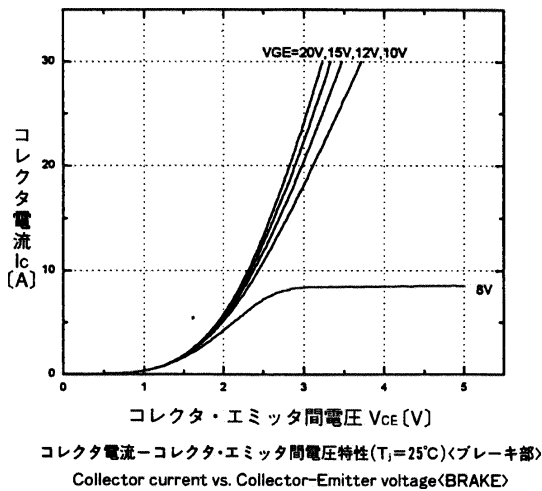
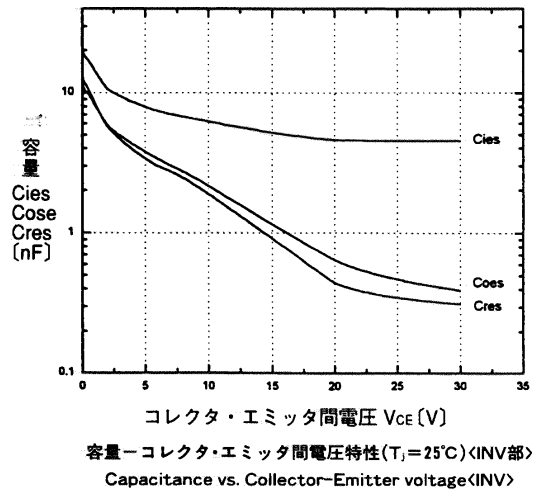
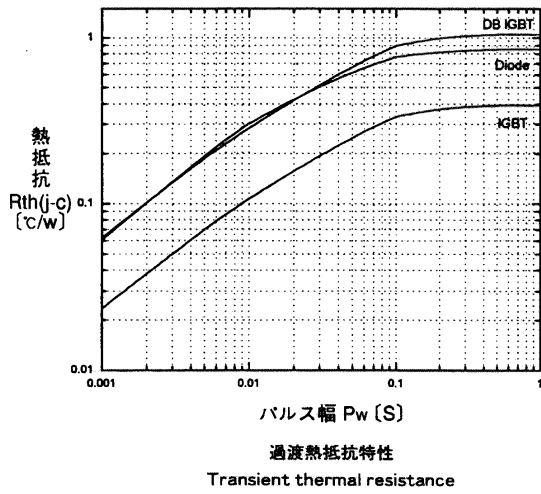

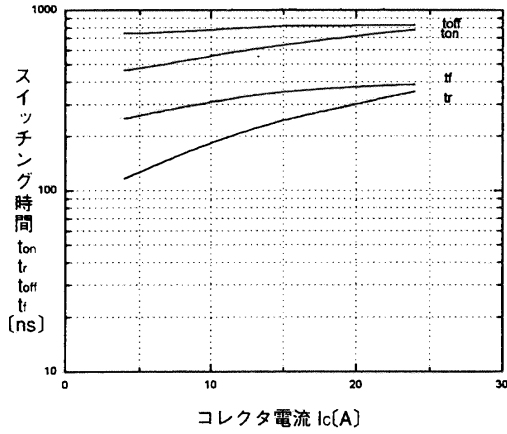

スイッチング時間-コレクタ電流特性 ($T_j = 25^\circ\text{C}$) <ブレーキ部>
Switching time vs. Collector current <BRAKE>

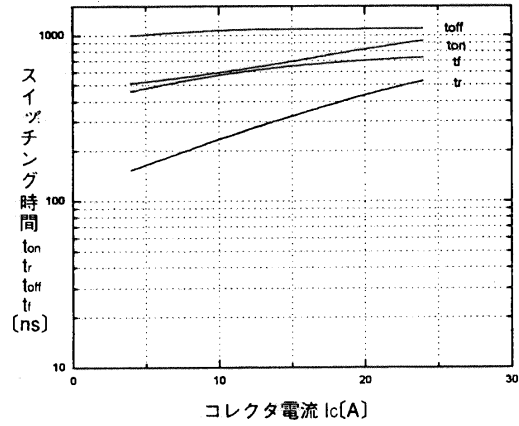

スイッチング時間-コレクタ電流特性 ($T_j = 125^\circ\text{C}$) <ブレーキ部>
Switching time vs. Collector current <BRAKE>

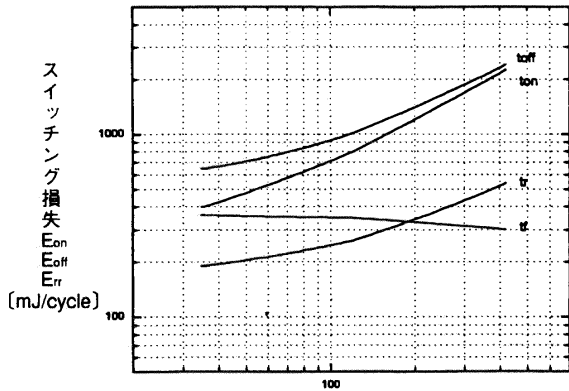

ゲート抵抗 R_g (Ω)
スイッチング時間-ゲート抵抗特性 ($T_j = 25^\circ\text{C}$) <ブレーキ部>
Switching time vs. Gate resistance <BRAKE>

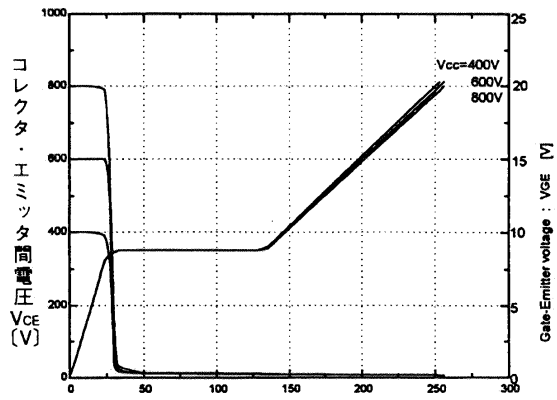

充電電荷量 Q_g (nC)
ダイナミック入力特性 ($T_j = 25^\circ\text{C}$) <ブレーキ部>
Dynamic input characteristic <BRAKE>

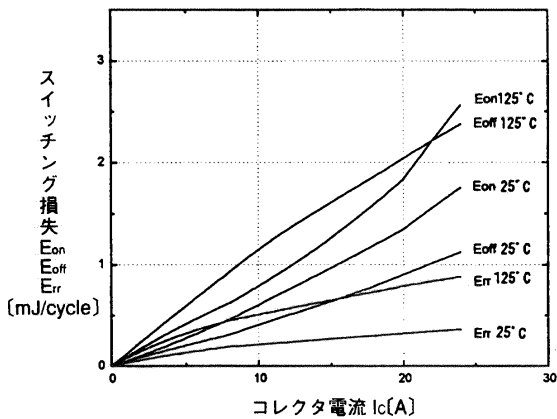

スイッチング損失-コレクタ電流特性 <ブレーキ部>
Switching loss vs. Collector current <BRAKE>

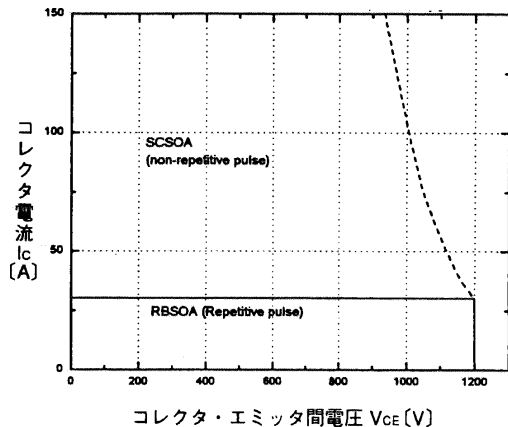

安全動作領域(逆バイアス) ($T_j \leq 125^\circ\text{C}$) <ブレーキ部>
Reverse biased safe operating area <BRAKE>

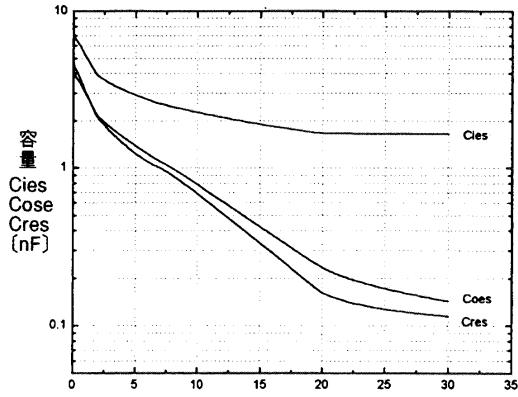

コレクタ・エミッタ間電圧 V_{CE} (V)

容量-コレクタ・エミッタ間電圧特性 (T_v=25°C) <ブレーキ部>
Capacitance vs. Collector-Emitter voltage <BRAKE>

■ Outline Drawings, mm

