

PRELIMINARY SPEC

Part Number: APT2012RWF/A

WHITE



ATTENTION
OBSERVE PRECAUTIONS
FOR HANDLING
ELECTROSTATIC
DISCHARGE
SENSITIVE
DEVICES

Features

- 2.0mmx1.25mm SMT LED,0.75mm THICKNESS.
- LOW POWER CONSUMPTION.
- WIDE VIEWING ANGLE.
- IDEAL FOR BACKLIGHT AND INDICATOR.
- VARIOUS COLORS AND LENS TYPES AVAILABLE.
- PACKAGE : 2000PCS / REEL.
- MOISTURE SENSITIVITY LEVEL : LEVEL 3.
- ELECTROSTATIC DISCHARGE THRESHOLD (HBM):1000V.
- TYP. COLOR TEMPERATURE:6500K
- COLOR COORDINATES:X=0.31,Y=0.31 ACC. TO CIE1931(WHITE).
- OPTICAL EFFICIENCY:8.1 lm/W(TYP.)
- COLOR REPRODUCTION INDEX:80
- RoHS COMPLIANT.

Description

The source color devices are made with InGaN on SiC Light Emitting Diode.

Static electricity and surge damage the LEDs.

It is recommended to use a wrist band or anti-electrostatic glove when handling the LEDs.

All devices, equipment and machinery must be electrically grounded.

Applications

- traffic signaling.
- backlighting (illuminated advertising , general lighting).
- interior and exterior automotive lighting.
- substitution of micro incandescent lamps.
- Reading camps.
- signal and symbol luminaire for orientation.
- marker lights (e.g. steps, exit ways, etc).
- decorative and entertainment lighting.
- indoor and outdoor commercial and residential architectural lighting.

Package Dimensions

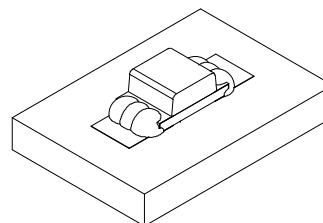
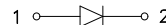
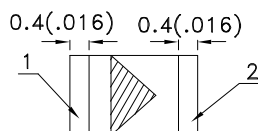
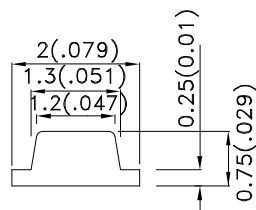
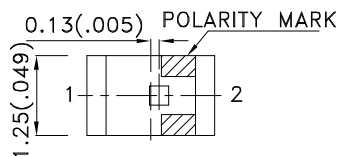

Notes:

1. All dimensions are in millimeters (inches).
2. Tolerance is $\pm 0.1(0.004)$ unless otherwise noted.
3. Specifications are subject to change without notice.
4. The device has a single mounting surface. The device must be mounted according to the specifications.



Selection Guide

Part No.	Dice	Lens Type	Luminous Intensity ^{Note2} Iv(mcd) @ 20 mA		Φ_v (mIm) ^{Note3} @ 20 mA	Viewing Angle ^{Note1}
			Min.	Typ.	Typ.	2 θ 1/2
APT2012RWF/A	WHITE (InGaN)	YELLOW FLUORESCENT	70	140	520	120°

Absolute Maximum Ratings at TA=25°C

Parameter	Symbol	Value	Unit
Power dissipation	Pt	120	mW
Reverse Voltage	VR	5	V
Junction temperature	TJ	110	°C
Operating Temperature	Top	-40 To +85	°C
Storage Temperature	Tstg	-40 To +100	°C
DC Forward Current	IF	30	mA
Peak Forward Current ^{Note4}	IFM	100	mA
Thermal resistance Junction/ambient ^{Note5} Junction/solder point	Rth JA Rth JS	350 130	°C/W °C/W

Notes:

1. θ 1/2 is the angle from optical centerline where the luminous intensity is 1/2 the optical centerline value.
2. Luminous intensity is measured by a current pulse of 10ms at a tolerance of $\pm 15\%$.
3. The typical data of Luminous Flux can only reflect statistical figures, actual parameters of individual product could differ from the typical data. For the purpose of product enhancement, the typical data is subject to change without prior notice.
4. 1/10 Duty Cycle, 0.1ms Pulse Width.
5. Rth(J-A) Results from mounting on PC board FR4 (pad size $\geq 16 \text{ mm}^2$ per pad),

Electrical / Optical Characteristics at TA=25°C

Parameter	Symbol	Value	Unit
Chromaticity coordinate x acc.to CIE1931 IF=20mA [Typ.]	X ^{Note1}	0.31	-
Chromaticity coordinate y acc.to CIE1931 IF=20mA [Typ.]	Y ^{Note1}	0.31	-
Forward Voltage IF=20mA [Min.]	VF ^{Note2}	2.7	V
Forward Voltage IF=20mA [Typ.]		3.2	
Forward Voltage IF=20mA [Max.]		4.0	
Reverse Current (VR=5V) [Typ.]	IR	0.01	μA
Reverse Current (VR=5V) [Max.]		10	
Temperature coefficient of x IF=20mA, $-10^\circ\text{C} \leq T \leq 100^\circ\text{C}$ [Typ.]	TCx	-0.1	$10^{-3}/^\circ\text{C}$
Temperature coefficient of y IF=20mA, $-10^\circ\text{C} \leq T \leq 100^\circ\text{C}$ [Typ.]	TCy	-0.2	$10^{-3}/^\circ\text{C}$
Temperature coefficient of VF IF=20mA, $-10^\circ\text{C} \leq T \leq 100^\circ\text{C}$ [Typ.]	TCV	-2.5	mV/°C

Notes:

1. Chromaticity coordinates are measured by a current pulse of 20ms with a tolerance of ± 0.01 in X and Y color coordinates.
2. Forward voltage is measured with a current pulse of 10ms at a tolerance of $\pm 0.1\text{V}$.

Brightness codes

Code.	luminous Intensity ^{Note1} Iv(mcd) @ 20 mA		Φ_v (mlm) ^{Note2} @ 20 mA
	Min.	Max.	Typ.
M	70	130	300
N	110	220	480
P	180	320	710
Q	280	420	960

Notes:

1.Luminous intensity is measured by a current pulse of 10ms at a tolerance of $\pm 15\%$.

2.The typical data of Luminous Flux can only reflect statistical figures, actual parameters of individual product could differ from the typical data. For the purpose of product enhancement, the typical data is subject to change without prior notice.

White

APT2012RWF/A

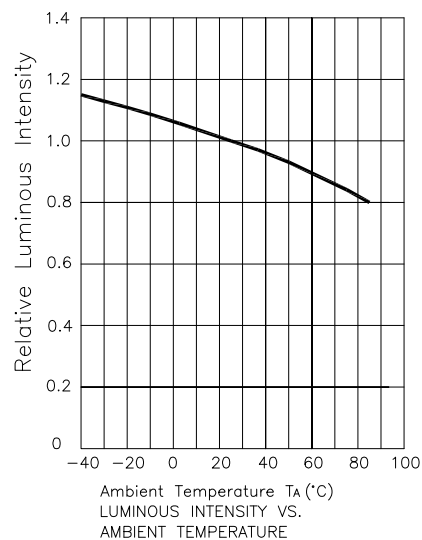
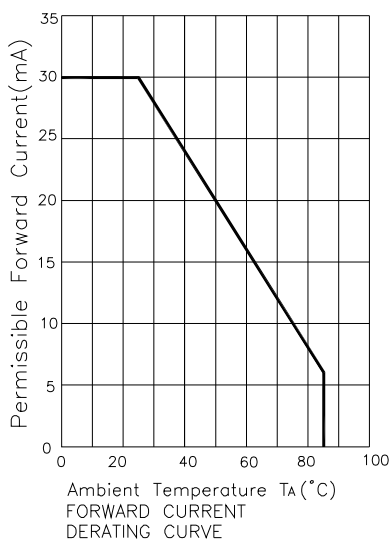
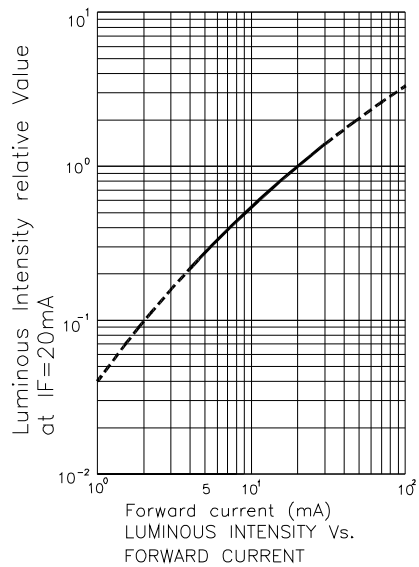
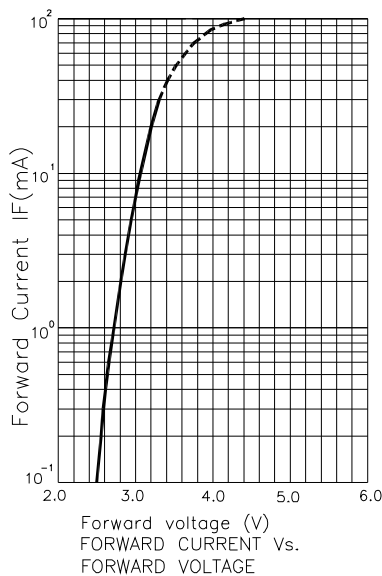

APT2012RWF/A

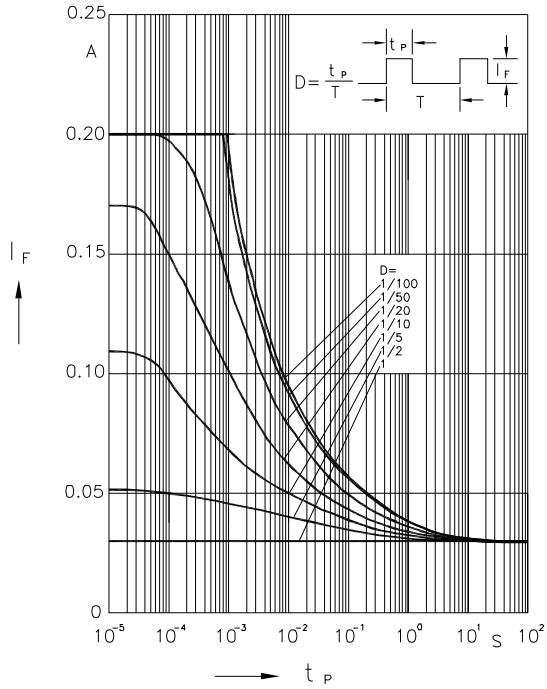

Permissible Pulse Handling Capability
Duty cycle $D = \text{parameter}$, $T_A = 25^\circ\text{C}$

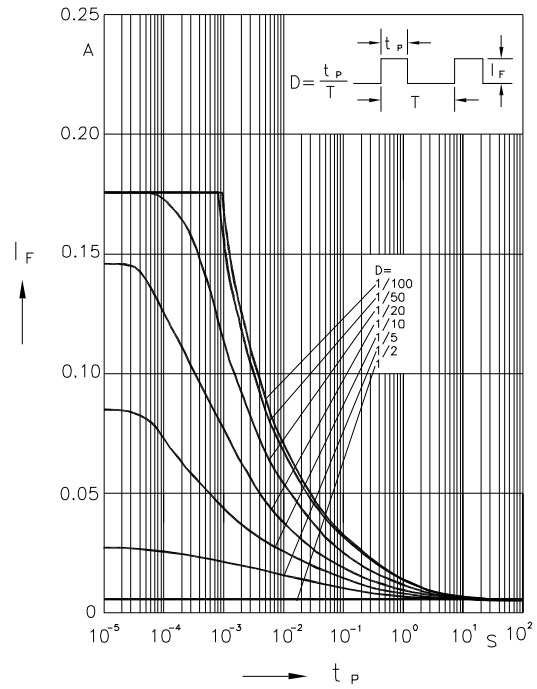

Permissible Pulse Handling Capability
Duty cycle $D = \text{parameter}$, $T_A = 85^\circ\text{C}$

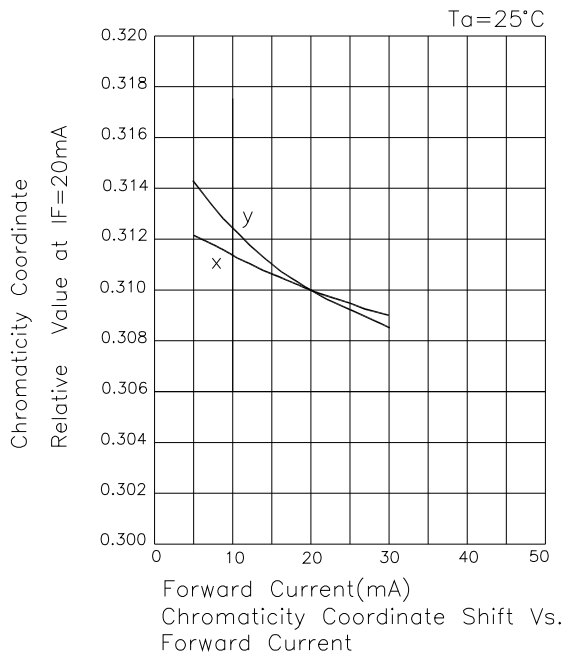

Chromaticity Coordinate
Relative Value at $I_F = 20\text{mA}$
 $T_A = 25^\circ\text{C}$
Chromaticity Coordinate Shift Vs.
Forward Current

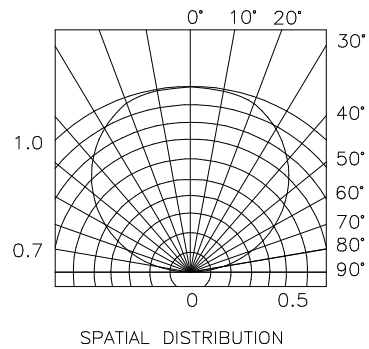
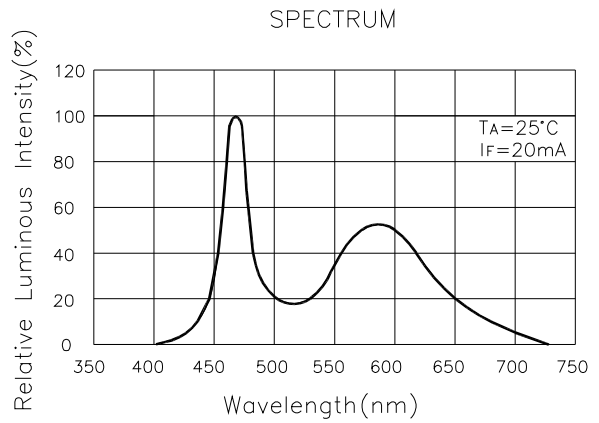

APT2012RWF/A

White CIE

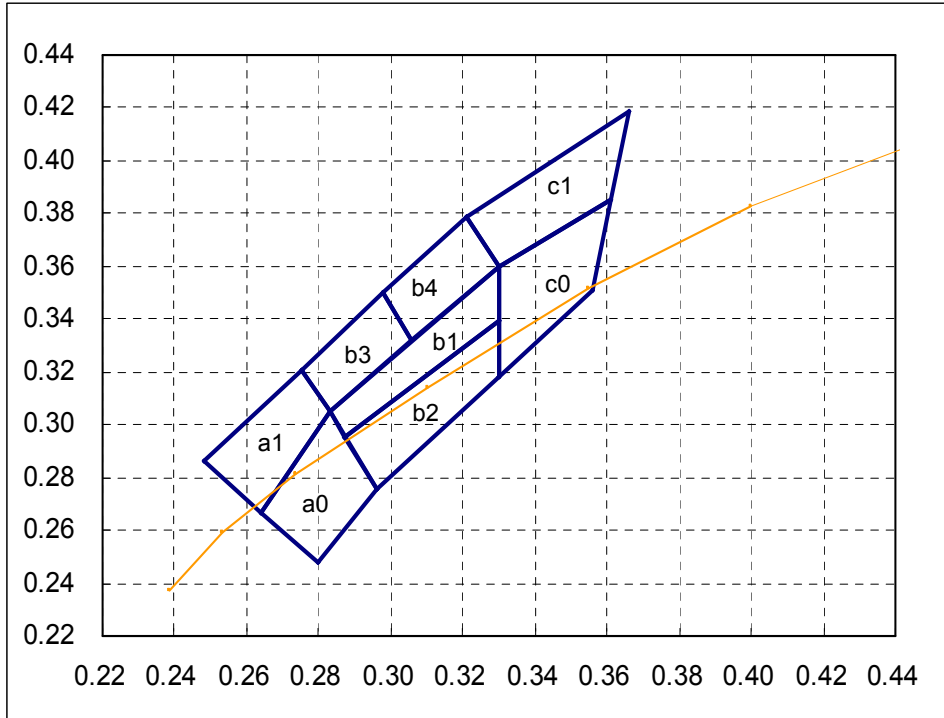

a0				
X	0.264	0.283	0.296	0.280
Y	0.267	0.305	0.276	0.248
Reference CCT: 14000~9000k				
b1				
X	0.283	0.330	0.330	0.287
Y	0.305	0.360	0.339	0.295
Reference CCT: 9000~5600k				
b3				
X	0.275	0.298	0.306	0.283
Y	0.321	0.350	0.332	0.305
Reference CCT: 9000~7000k				
c0				
X	0.330	0.361	0.356	0.330
Y	0.360	0.385	0.351	0.318
Reference CCT: 5600~4600k				
a1				
X	0.248	0.275	0.283	0.264
Y	0.286	0.321	0.305	0.267
Reference CCT: 14000~9000k				
b2				
X	0.287	0.330	0.330	0.296
Y	0.295	0.339	0.318	0.276
Reference CCT: 9000~5600k				
b4				
X	0.298	0.321	0.330	0.306
Y	0.350	0.379	0.360	0.332
Reference CCT: 7600~5600k				
c1				
X	0.321	0.366	0.361	0.330
Y	0.379	0.419	0.385	0.360
Reference CCT: 6000~4600k				

APT2012RWF/A

Reflow Soldering Profile For Lead-free SMT Process.

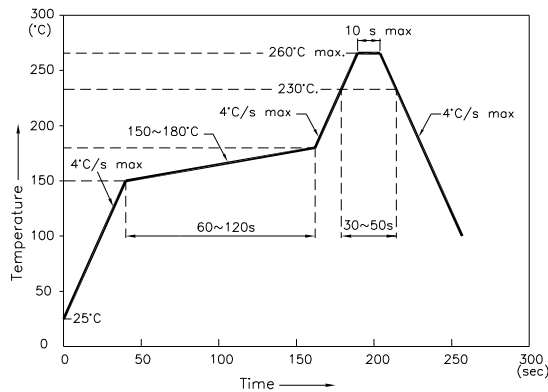

NOTES:

1. We recommend the reflow temperature 245°C(+/-5°C). The maximum soldering temperature should be limited to 260°C.
2. Don't cause stress to the epoxy resin while it is exposed to high temperature.
3. Number of reflow process shall be 2 times or less.

Recommended Soldering Pattern (Units: mm ; Tolerance: ± 0.1)

Pad design for improved heat dissipation

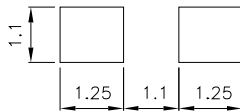

Cu-area ≥ 16mm²
per pad

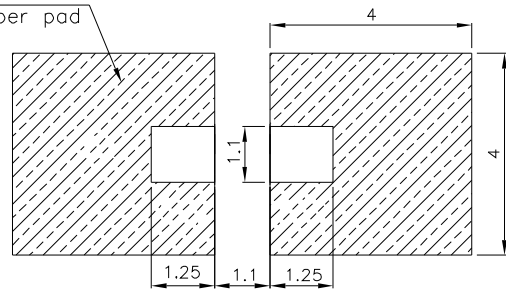

▨ Solder resist

Tape Specifications (Units : mm)

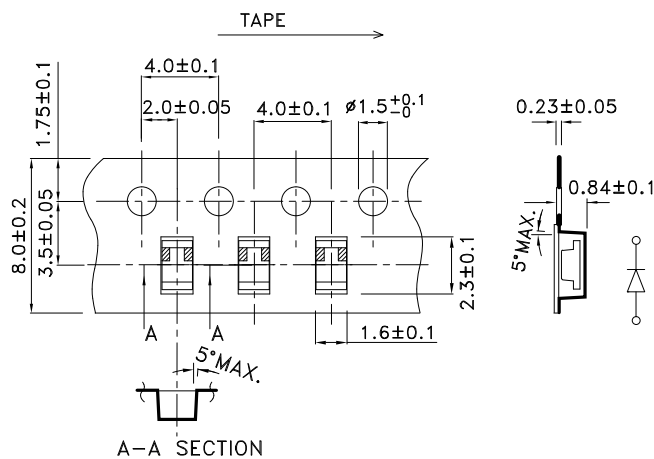

Reel Dimension

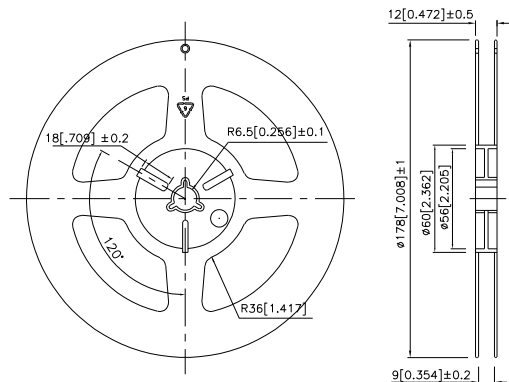

Kingbright

PACKING & LABEL SPECIFICATIONS

APT2012RWF/A

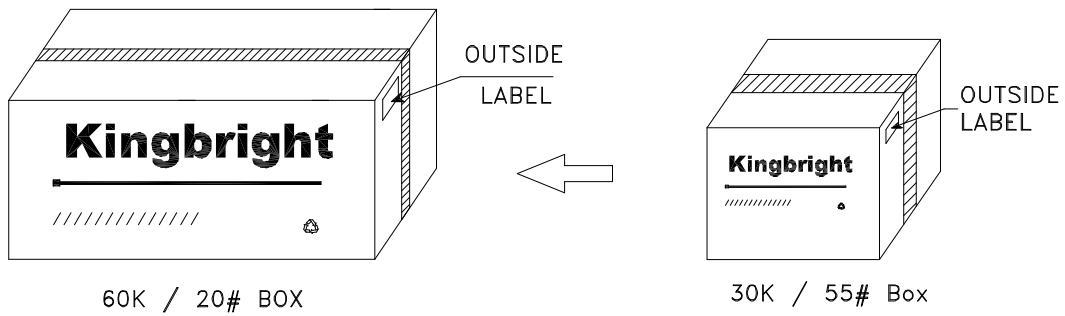
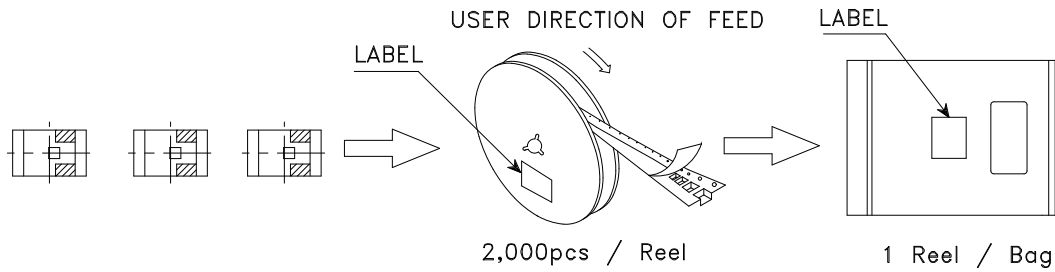

<h1>Kingbright</h1>	
P/NO: APT2012xxx	
QTY: 2,000 pcs	Q.C. Q C xx xx xxxx PASSED
S/N: XXXX	
CODE: XXX	
LOT NO:	
 <small>xxxxxxxxxxxxxxxxxxxxxxxx</small>	
RoHS Compliant	