

P-Channel Enhancement-Mode MOSFET Transistors

PRODUCT SUMMARY				
Part Number	$V_{(BR)DSS}$ Min (V)	$r_{DS(on)}$ Max (Ω)	$V_{GS(th)}$ (V)	I_D (A)
VP0300B	-30	2.5 @ $V_{GS} = -12$ V	-2 to -4.5	-1.25
VP0300L		2.5 @ $V_{GS} = -12$ V	-2 to -4.5	-0.32
VP0300LS		2.5 @ $V_{GS} = -12$ V	-2 to -4.5	-0.5
VQ2001J		2 @ $V_{GS} = -12$ V	-2 to -4.5	-0.6
VQ2001P		2 @ $V_{GS} = -12$ V	-2 to -4.5	-0.6

FEATURES

- High-Side Switching
- Low On-Resistance: 1.5 Ω
- Moderate Threshold: -3.1 V
- Fast Switching Speed: 17 ns
- Low Input Capacitance: 60 pF

BENEFITS

- Ease in Driving Switches
- Low Offset (Error) Voltage
- Low-Voltage Operation
- High-Speed Switching
- Easily Driven Without Buffer

APPLICATIONS

- Drivers: Relays, Solenoids, Lamps, Hammers, Displays, Memories, Transistors, etc.
- Battery Operated Systems
- Power Supply, Converter Circuits
- Motor Control

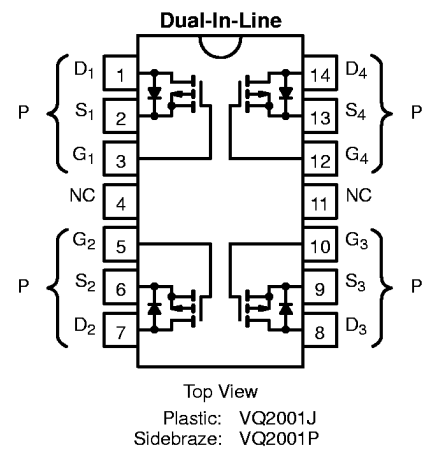
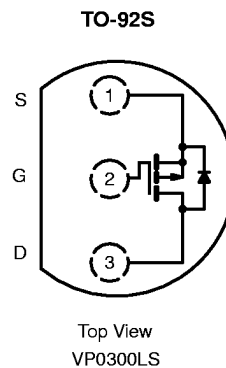
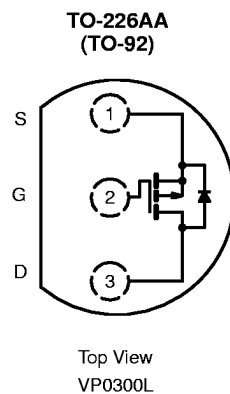
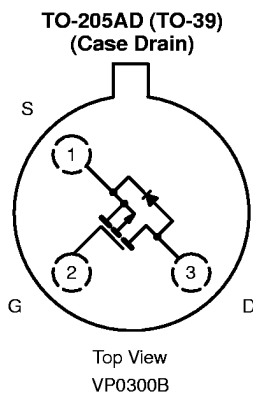

ABSOLUTE MAXIMUM RATINGS ($T_A = 25^\circ\text{C}$ UNLESS OTHERWISE NOTED)								
Parameter	Symbol	VP0300B	VP0300L	VP0300LS	VQ2001J/P		Unit	
					Single	Total Quad		
Drain-Source Voltage	V_{DS}	-30	-30	-30	-30	-30	V	
Gate-Source Voltage	V_{GS}	± 20	± 20	± 20	± 20	± 20		
Continuous Drain Current ($T_J = 150^\circ\text{C}$)	I_D	$T_A = 25^\circ\text{C}$	-1.25 ^b	-0.32	-0.5	-0.6	-0.6	A
		$T_A = 100^\circ\text{C}$	-0.79 ^b	-0.2	-0.32	-0.37	-0.37	
Pulsed Drain Current ^a	I_{DM}	-3	-2.4	-3	-2	-2		
Power Dissipation	P_D	$T_A = 25^\circ\text{C}$	6.25 ^b	0.8	0.9	1.3	2	W
		$T_A = 100^\circ\text{C}$	2.5 ^b	0.32	0.4	0.52	0.8	
Maximum Junction-to-Ambient	R_{thJA}	20 ^b	156	139	96	62.5	$^\circ\text{C/W}$	
Operating Junction and Storage Temperature Range	T_J, T_{stg}	-55 to 150						$^\circ\text{C}$

Notes

- a. Pulse width limited by maximum junction temperature.
 b. Power dissipation and continuous drain current at $T_C = 25^\circ\text{C}$; $R_{thJC} = 20^\circ\text{C/W}$.

Applications information may also be obtained via FaxBack, request document #70611.



SPECIFICATIONS (T _A = 25 °C UNLESS OTHERWISE NOTED)								
Parameter	Symbol	Test Conditions	Typ ^a	Limits				Unit
				VP0300B/L/LS		VQ2001J/P		
				Min	Max	Min	Max	
Static								
Drain-Source Breakdown Voltage	V _{(BR)DSS}	V _{GS} = 0 V, I _D = -10 μA	-55	-30		-30		V
Gate-Threshold Voltage	V _{GS(th)}	V _{DS} = V _{GS} , I _D = -1 mA	-3.1	-2	-4.5	-2	-4.5	
Gate-Body Leakage	I _{GSS}	V _{DS} = 0 V, V _{GS} = ±16 V					±100	nA
		T _J = 125 °C					±500	
		V _{DS} = 0 V, V _{GS} = ±20 V			±100			
Zero Gate Voltage Drain Current	I _{DSS}	V _{DS} = -24 V, V _{GS} = 0 V			-10			μA
		T _J = 125 °C			-500		-500	
		V _{DS} = -30 V, V _{GS} = 0 V					-10	
On-State Drain Current ^b	I _{D(on)}	V _{DS} = -10 V, V _{GS} = -12 V	-2.8	-1.5		-1.5		A
Drain-Source On-Resistance ^b	r _{DS(on)}	V _{GS} = -12 V, I _D = -1 A	1.5		2.5		2	Ω
		T _J = 125 °C	2.6		3.6		3.6	
Forward Transconductance ^b	g _{fs}	V _{DS} = -10 V, I _D = -0.5 A	370	200		200		mS
Common Source Output Conductance ^b	g _{os}	V _{DS} = -7.5 V, I _D = -0.05 A	0.25					
Dynamic								
Input Capacitance	C _{iss}	V _{DS} = -15 V, V _{GS} = 0 V f = 1 MHz	60		150		150	pF
Output Capacitance	C _{oss}		40		100		100	
Reverse Transfer Capacitance	C _{rss}		10		60		60	
Switching^c								
Turn-On Time	t _{ON}	V _{DD} = -25 V, R _L = 23 Ω I _D ≅ -1 A, V _{GEN} = -10 V R _G = 25 Ω	19		30			ns
Turn-Off Time	t _{OFF}		17		30			
Turn-On Time	t _{ON}	V _{DD} = -15 V, R _L = 23 Ω I _D ≅ -0.6 A, V _{GEN} = -10 V R _G = 25 Ω	19				30	
Turn-Off Time	t _{OFF}		16				30	

Notes

- a. For DESIGN AID ONLY, not subject to production testing.
- b. Pulse test: PW ≤ 300 μs duty cycle ≤ 2%.
- c. Switching time is essentially independent of operating temperature.

VPEA03



TYPICAL CHARACTERISTICS (25 °C UNLESS NOTED)

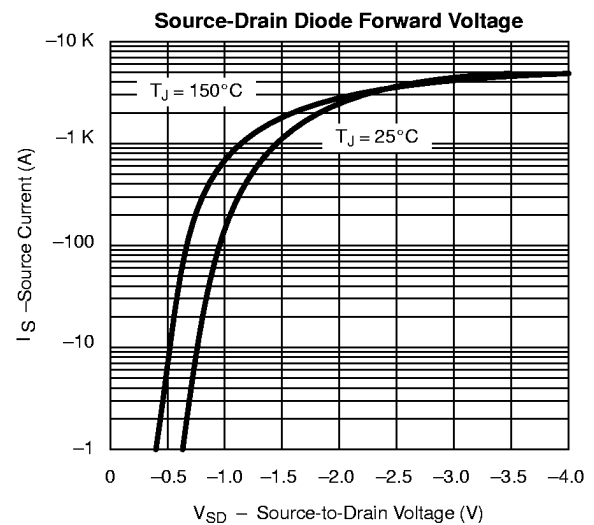
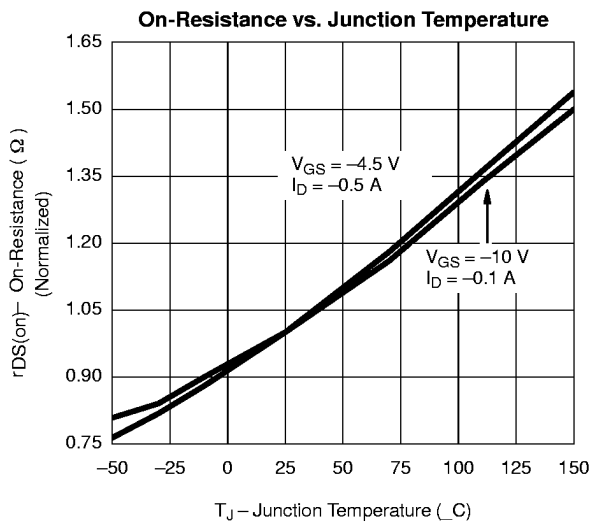
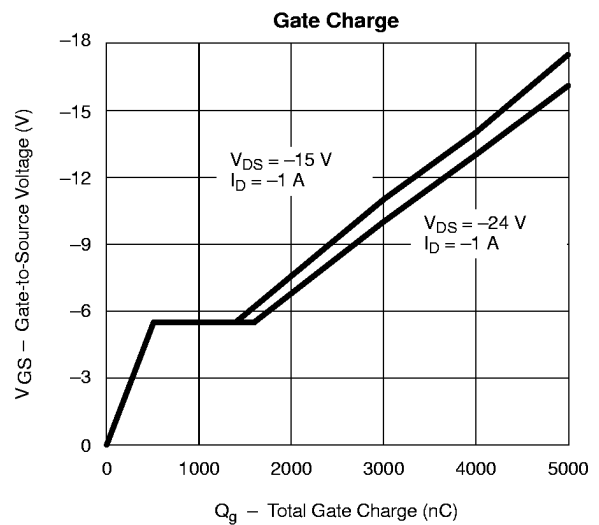
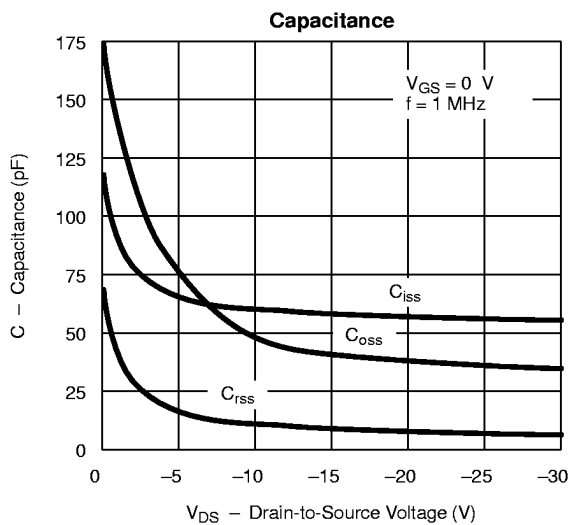
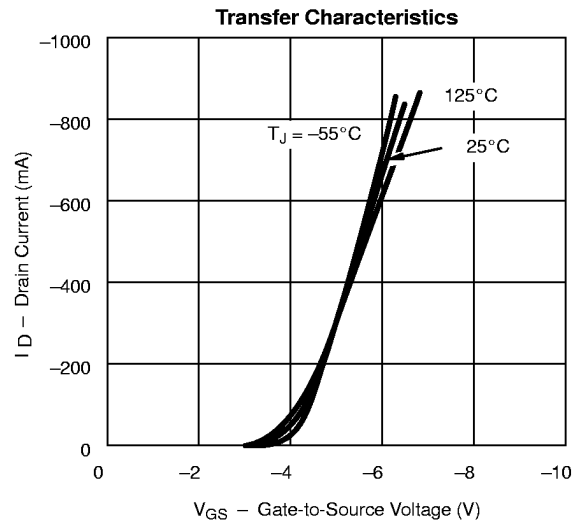
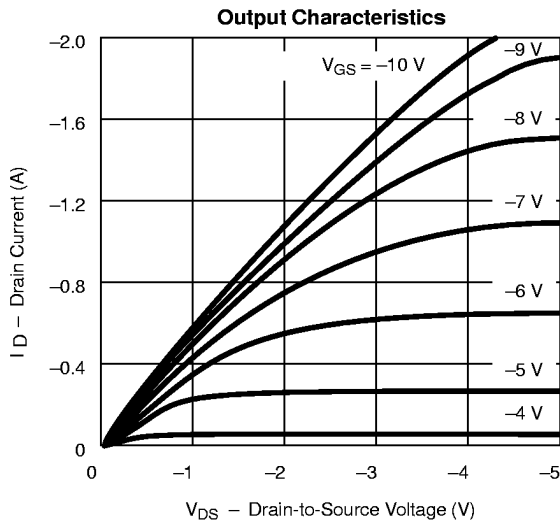

TYPICAL CHARACTERISTICS (25 °C UNLESS NOTED)

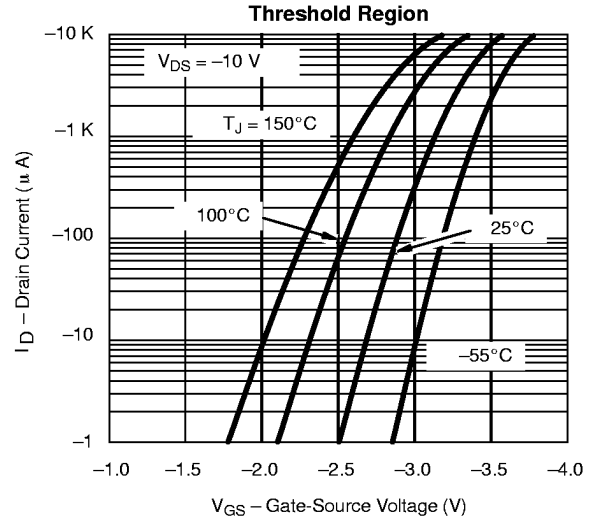
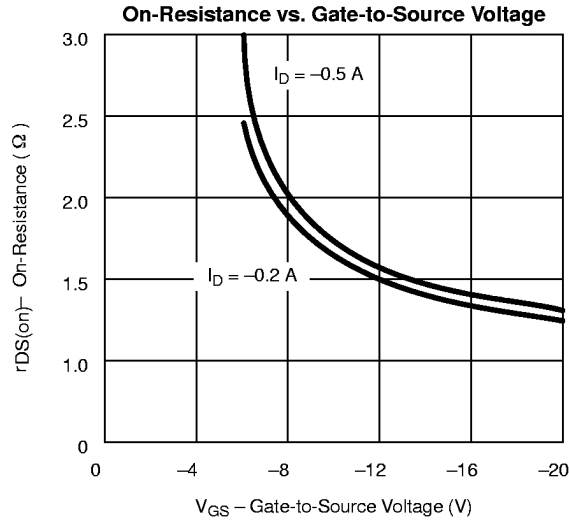

THERMAL RATINGS

