



T-75-07-07

# UM91260/61



## 10 Memory Tone/Pulse Dialer

### Features

- 32-digit redial memory (31 digits in tone mode)
- Ten indirect memories, 16 digits in pulse mode, 15 digits in tone mode
- Tone/Pulse mode switching via slide switch (4.1 second pause inserted automatically)
- Wide operating voltage: 1.8V ~ 5.5V
- Uses 480 KHz ceramic resonator
- Low memory retention current ( $\leq 0.1 \mu A$  at  $V_{DD} = 10V, \overline{HK} = 1$ )
- Selectable Make/Break ratio
- Selectable dialing rate (UM91261 only)
- Key-in tone output for valid keypad entry recognition (UM91261 only)

### General Description

The products in the UM91260/61 series are tone/pulse switchable dialers with ten 16-digit number memories and 32-digit redial memory. Pulse to tone mode switching is performed via a slide switch. The dialing rate and storage mode for each version of the UM91260 is shown at right. The UM91261 is a 22-pin version of the 91260 with key-in tone output and selectable dialing rate and storage mode.

### Ordering Information

Part No.	Dialing rate	Storage mode	Package
UM91260A/60AM	10 pps	Off-hook only	P-DIP 18L/ SO 20L
UM91260B/60BM	20 pps	On/Off-hook	P-DIP 18L/ SO 20L
UM91260C/60CM	10 pps	On/Off-hook	P-DIP 18L/ SO 20L
UM91260D/60DM	20 pps	Off-hook only	P-DIP 18L/ SO 20L
UM91261/61M	Pin Selectable	Pin Selectable	P-DIP 22L/ SO 24L

### Pin Configurations

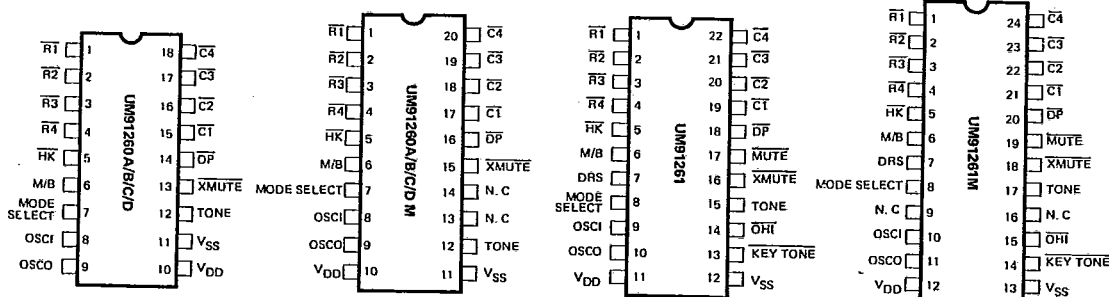



T-75-07-07

Keyboard Assignments

1	2	3	S	R1
4	5	6	A/L	R2
7	8	9	P	R3
*	0	#	R	R4
C1	C2	C3	C4	

S: Store  
 A/L: Auto/Location  
 P: Pause  
 R: Redial

Block Diagram

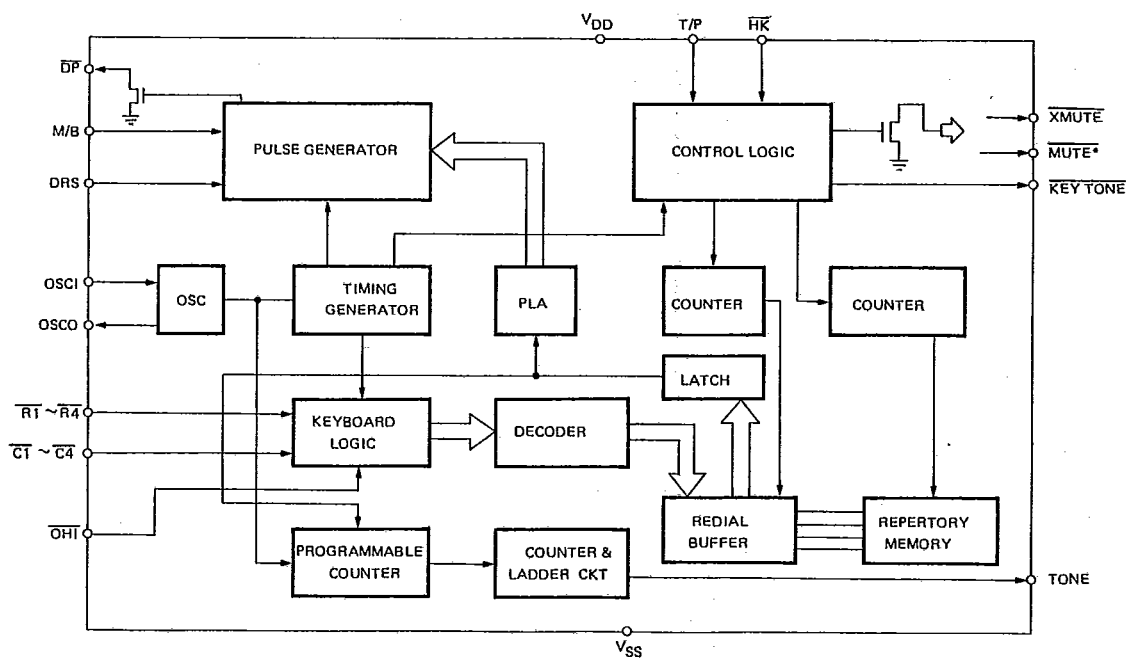



T-75-07-07

**Absolute Maximum Ratings\***

Power Supply Voltage ..... -0.3V to +6.0V  
 Input Voltage ..... -0.3V to V<sub>DD</sub> + 0.3V  
 Maximum Power Dissipation (at 25°C) ..... 500 mW  
 Operating Temperature (T<sub>OP</sub>) ..... -20°C to +70°C  
 Storage Temperature (T<sub>STG</sub>) ..... -55°C to +150°C

**\*Comments**

Stresses above those listed under "Absolute Maximum Ratings" may cause permanent damage to the device. These are stress ratings only. Functional operation of this device at these or any other conditions above those indicated in the operational sections of this specification is not implied and exposure to absolute maximum rating conditions for extended periods may affect device reliability.

**DC Characteristics** (V<sub>DD</sub> = 3.5V, V<sub>SS</sub> = 0V, F<sub>OSC</sub> = 480 KHz, T<sub>OP</sub> = 25°C, unless otherwise specified)

Parameter	Symbol	Min.	Typ.	Max.	Unit	Conditions	Test Ckt.
Operating Voltage	V <sub>DD</sub>	1.8		5.5	V	Pulse mode	A
		1.8		5.5		DTMF Mode	
Memory Retention Voltage	V <sub>MR</sub>	1			V		-
Memory Retention Current	I <sub>MR</sub>		0.05	0.4	µA	V <sub>DD</sub> = 1.0V All outputs unloaded HK = V <sub>DD</sub>	-
Supply Operating Current	I <sub>DDP</sub>		0.25	0.5	mA	Oscillator running; all outputs unloaded	A
	I <sub>DDT</sub>		0.46	1.0			
Standby Current	I <sub>SD</sub>		1.0	5.0	µA	HK = V <sub>SS</sub> V <sub>DD</sub> = 2.5V All outputs unloaded	A
Output Sink Current DP, MUTE, XMUTE	I <sub>OL1</sub>	1.0	2		mA	V <sub>OL</sub> = 0.4V	B
	I <sub>OL2</sub>	0.4	1			V <sub>OL</sub> = 0.4V V <sub>DD</sub> = 2.0V	
Input Voltage Range	V <sub>IH</sub>	0.8		1	V <sub>DD</sub>		-
	V <sub>IL</sub>	0		0.2			
Row Input Current	I <sub>R</sub>	5	10	20	µA	V <sub>IN</sub> = 0V All outputs unloaded	C
Column Input Current	I <sub>C</sub>	0.6	1.4	2.0	mA	V <sub>IN</sub> = 3.5V All outputs unloaded	C
Single Column Tone Output Amplitude	V <sub>OC</sub>	540	590	640	mV <sub>P-P</sub>	R <sub>LOAD</sub> = 10 KΩ V <sub>DD</sub> = 2.5V	D
		100	1200	1300		R <sub>LOAD</sub> = 10 KΩ V <sub>DD</sub> = 5.5V	D
Single Row Tone Output Amplitude	V <sub>OR</sub>	410	450	490	mV <sub>P-P</sub>	R <sub>LOAD</sub> = 10 KΩ V <sub>DD</sub> = 2.5V	D
		850	920	990		R <sub>LOAD</sub> = 10 KΩ V <sub>DD</sub> = 5.5V	D
Pre-emphasis	T <sub>WIST</sub>	1	2	3	dB		D
Valley of Single Tone	V <sub>V</sub>	0.40	0.46	0.52	V <sub>DD</sub>		D
Distortion	DIS%		1	5	%	*Note 1	D

Note 1:  $DIS(\%) = \frac{100 \cdot (V_1^2 + V_2^2 + \dots + V_n^2)^{1/2}}{(V_{IL}^2 + V_{IH}^2)^{1/2}}$

- a. V<sub>1</sub> ..... V<sub>n</sub> are the intermodulation or the harmonic frequencies in the 500 Hz to 3400 Hz band.
- b. V<sub>IL</sub>, V<sub>IH</sub> are the individual frequency components of the DTMF signal.



UM91260/61

T-75-07-07

AC Characteristics

Parameter	Symbol	Conditions	Min.	Typ.	Max.	Unit
PULSE						
Make/Break Ratio	M/B	M/B Terminal = V <sub>DD</sub>		1/2		
		M/B Terminal = V <sub>SS</sub>		2/3		
Dial Pulse Rate	DR	DRS = V <sub>DD</sub> (20 pps Selection)		20		PPS
		DRS = V <sub>SS</sub> (10 pps Selection)		10		
Make Time	T <sub>M</sub>	10 pps	MB = 1/2	33.3		ms
			MB = 2/3	40.0		
		20 pps	M/B = 1/2	16.7		
			M/B = 2/3	20.0		
Break Time	T <sub>B</sub>	10 pps	M/B = 1/2	66.6		ms
			M/B = 2/3	60		
		20 pps	M/B = 1/2	33.3		
			M/B = 2/3	30		
Inter-Digit Pause Time	T <sub>IDP</sub>	10 pps	M/B = 1/2	806		ms
			M/B = 2/3	800		
		20 pps	M/B = 1/2	523		
			M/B = 2/3	520		
Pre-Digit Pause	T <sub>PDP</sub>	10 pps	M/B = 1/2	840		ms
			M/B = 2/3	840		
		20 pps	M/B = 1/2	540		
			M/B = 2/3	540		
$\overline{\text{XMUTE}}$ MUTE DELAY Time	T <sub>MDP</sub>	10 pps	M/B = 1/2	0		ms
			M/B = 2/3	0		
		20 pps	M/B = 1/2	0		ms
			M/B = 2/3	0		
TONE						
Minimum Tone Duration	T <sub>MFD</sub>			110		ms
Min. Tone Inter-Digit Pause	T <sub>TIDP</sub>			110		ms
Tone Output Pre-Digit Pause	T <sub>TPDP</sub>			130		ms
$\overline{\text{XMUTE}}$ Delay Time	T <sub>MDT</sub>			110		ms
Auto Pause Time	T <sub>AP</sub>			4.1		S
Oscillator Start-up Time	T <sub>START</sub>			8		ms

Tone/Pulse Dialer



UM91260/61

T-75-07-07

AC Characteristics (Continued)

Parameter	Symbol	Conditions	Min.	Typ.	Max.	Unit
X MUTE, MUTE Start-up Time	$T_{MS}$			30		ms
KEY-IN						
Keypad Debounce Time	$T_{KD}$			22		ms
Key Scan Frequency	$F_{KS}$	$\overline{C1} \sim \overline{C4}, \overline{R1} \sim \overline{R4}$		377		Hz
KEY-IN TONE						
KT, Duration Time	$T_{KTD}$			42		ms
KT Frequency	$F_{KT}$			1.2		KHz
KT Start-up Time	$T_{KTSTART}$			30		ms

R/C	Conditions	Spec.	Actual	Error (%)	Unit
$\overline{R1}$	$F_{osc} = 480 \text{ KHz}$	697	695.65	-0.19	HZ
$\overline{R2}$		770	769.23	-0.1	HZ
$\overline{R3}$		852	851.06	-0.11	HZ
$\overline{R4}$		941	941.18	+0.02	HZ
$\overline{C1}$		1209	1212.12	+0.26	HZ
$\overline{C2}$		1336	1333.33	-0.2	HZ
$\overline{C3}$		1477	1481.48	+0.3	HZ

Pin Description

Pin No.		Designation	Description
91260	91261		
1	1	$\overline{R1} \sim \overline{R4}$  $\overline{C1} \sim \overline{C4}$	Key inputs. When a row and a column are connected, a key operation is activated. If the On-Hook Store pin is inhibited, the row and column pins remain at high impedance in the On-Hook state. If the On-Hook Store pin is available, the column input is pulled low and the row input is pulled high. Scanning signals are present on both the row and column pins during a valid key-in condition. The key-in debounce time is typically 22 ms.
2	2		
3	3		
4	4		
15	19		
16	20		
17	21		
18	22		
5	5	HK	Hook switch input. When $\overline{HK} = V_{DD}$ , an On-Hook state exists. When $\overline{HK} = V_{SS}$ , an Off-Hook state exists.
6	6	M/B	Dial pulse Make/Break ratio select input. If $M/B = V_{DD}$ , the Make/Break ratio is 1/2. If $M/B = V_{SS}$ , the Make/Break ratio is 2/3.



T-75-07-07

Pin Description (Continued)

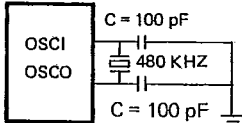
Pin No.		Designation	Description
91260	91261		
-	7	DRS	Dialing rate select input. If DRS = V <sub>DD</sub> , the dialing rate is 20 pps. If DRS = V <sub>SS</sub> , the dialing rate is 10 pps.
7	8	MODE SELECT	Pulse/DTMF mode select input. If MODE SELECT = V <sub>DD</sub> , Pulse mode is in effect. If MODE SELECT = V <sub>SS</sub> , DTMF mode is in effect.
8 9	9 10	OSCI OSCO	Oscillator I/O. A 480 KHz ceramic resonator and two 100 pF serial loading capacitors form a complete oscillator circuit. The circuit is activated when $\overline{HK}$ is low. Oscillator start-up time is typically 10 ms.  
10 11	11 12	V <sub>DD</sub> V <sub>SS</sub>	Positive power supply. Negative power supply. Operating voltage range: Pulse mode = 1.8V to 5.5V DTMF mode = 1.8V to 5.5V
-	13	$\overline{KEY-TONE}$	Key-in tone output. This output is valid for both Pulse and Tone modes. Output frequency is 1.5 KHz and has a duration of 42.6 ms after a valid key-in is detected. This function is only available on the UM91261.
-	14	$\overline{OHI}$	On-Hook store. On-hook store function is available when this input is high, inhibited when this input is low.
12	15	TONE	DTMF signal output. Pull-down load resistance is 10,000Ω. The minimum tone and IDP durations are built-in for both normal dialing and redialing.
13	16	$\overline{X MUTE}$	Transmit mute output. This is an N-channel open drain output. The output transistor is switched on while a sequence of digits is being dialed (for both Pulse and Tone modes). Otherwise, it is switched off.
-	17	MUTE	Mute output. This is an N-channel open drain output. The output transistor is switched on while a sequence of pulse digits is being dialed. Otherwise, it is switched off.
14	18	$\overline{DP}$	Dial pulse output. This pin is an N-channel open drain output. When $\overline{DP}$ output is low (switched on), it serves as a break signal in Pulse dialing. For other operations, $\overline{DP}$ output is normally high impedance (switched off).

Tone/Pulse Dialer



**UM91260/61**  
T-75-07-07

**Operational Procedures**

**9-1 Symbol definitions**

- a.  $D_p$ : Pulse digit, 1, 2, 3, 4, 5, 6, 7, 8, 9, 0
- b.  $D_t$ : tone digit, 1, 2, 3, 4, 5, 6, 7, 8, 9, 0, \*, #
- c.  $LOC_i$ :  $i = 1, 2, 3, 4, 5, 6, 7, 8, 9, 0$
- d. ZIZIZI: Conversation mode
- e.  $0-0 \uparrow$  : OFF-HOOK
- f.  $0-0 \downarrow$  : ON-HOOK
- g.  $\uparrow$  : Input Level from Low to high
- h.  $\downarrow$  : Input Level from High to Low.

**9-2 Recommended dialing, redialing, mixed dialing and storing operations**

1. Normal dialing in pulse mode  
 $0-0 \uparrow, D_p \dots D_p, ZIZIZI 0-0 \downarrow$
2. Normal dialing in tone mode  
 $0-0 \uparrow, D_t \dots D_t, ZIZIZI 0-0 \downarrow$
3. Mixed dialing in pulse-to-tone mode  
 $0-0 \uparrow, D_p \dots D_p \text{ MODE SELECT.}$   
 $\downarrow D_t \dots D_t, ZIZIZI 0-0 \downarrow$
4. Redialing  
 $0-0 \uparrow, D_p \dots D_p \cdot 0-0 \downarrow, 0-0 \uparrow,$   
 $R, ZIZIZI, 0-0 \downarrow$   
 $0-0 \uparrow, D_t \dots D_t \cdot 0-0 \downarrow, 0-0 \uparrow,$   
 $R, ZIZIZI, 0-0 \downarrow$

5. Storing Numbers to Repertory Memory  
(i) Off-hook Store  $0-0 \uparrow, [S], D_p \dots D_p \text{ or } D_t \dots D_t$   
 $[A/L], LOC_i, 0-0 \downarrow$   
(ii) On/Off-hook store:  $0-0 \downarrow, [S], D_p \dots D_p \text{ or } D_t \dots D_t$   
 $[A/L], LOC_i,$
6. Dialing from Repertory Memory  
 $0-0 \uparrow, [A/L], LOC_i, ZIZIZI 0-0 \downarrow$

**Functional Description**

1. N-Channel Open Drain Output -  $\overline{DP}, \overline{XMUTE}, \overline{MUTE}$ ,

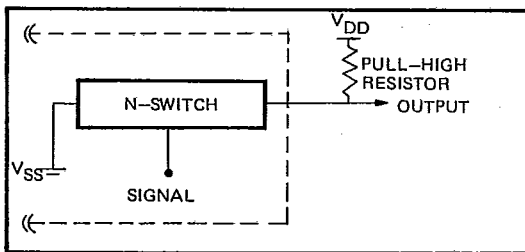

Figure. 1

2. DTMF Generator  
The digitally synthesized sinewave of the UM91260 series is well designed, with a 6 level, 12 segment,  $1/2 V_{DD}$  reference voltage (see Fig. 2). The THD (Total Harmonic Distortion) of the DTMF output is typically 1%, when  $V_{DD} = 2.5V$  to  $5.5V$  and frequency is in the 500 HZ to 3400 HZ band.  
DTMF Signal THD vs. operating voltage and DTMF output amplitude vs. operating voltage is shown in figures 3 and 4.

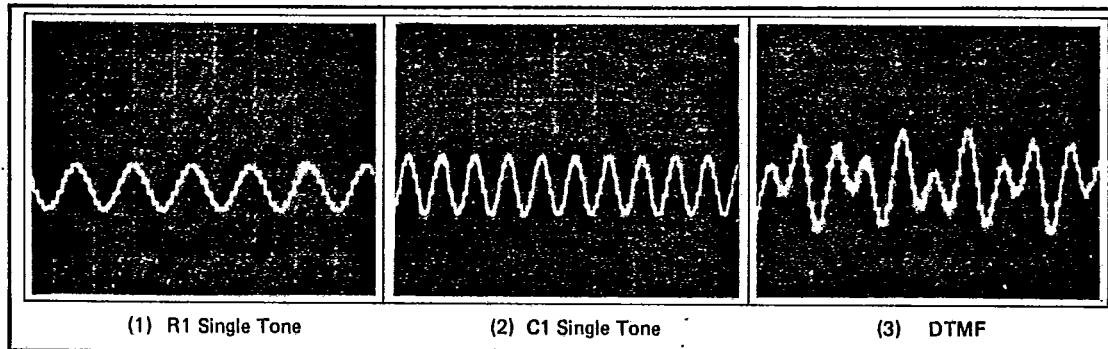

Figure 2 Waveforms



UM91260/61

T-75-07-07

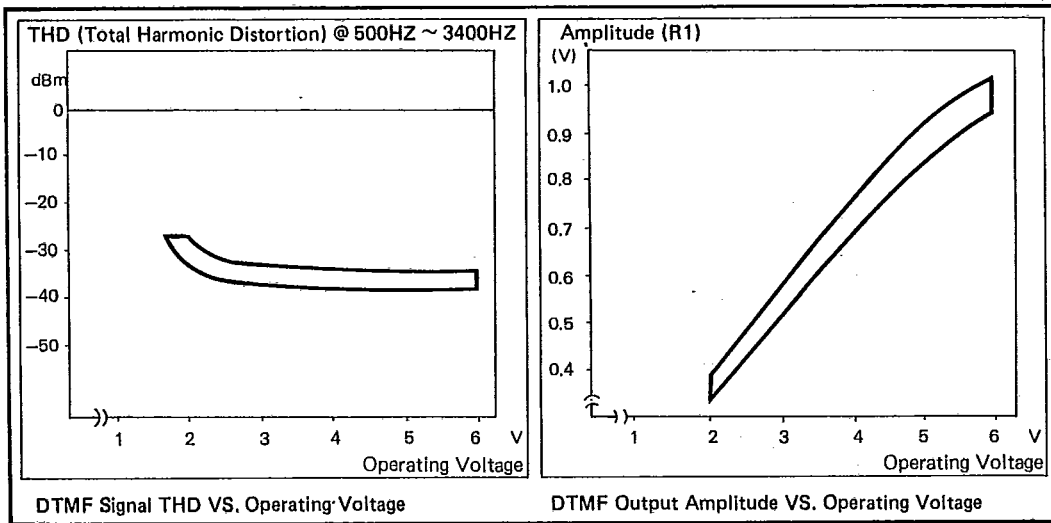

Figure 3

Figure 4



Timing Diagrams

(1) PULSE MODE TIMING DIAGRAM

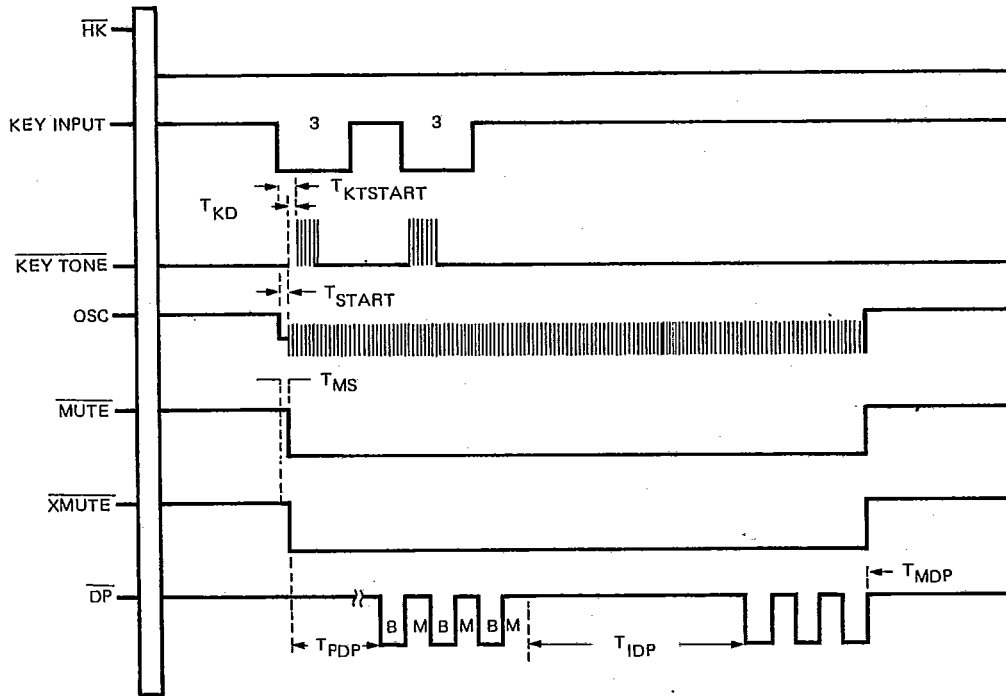





UM91260/61  
T-75-07-07

(2) TONE MODE TIMING DIAGRAM

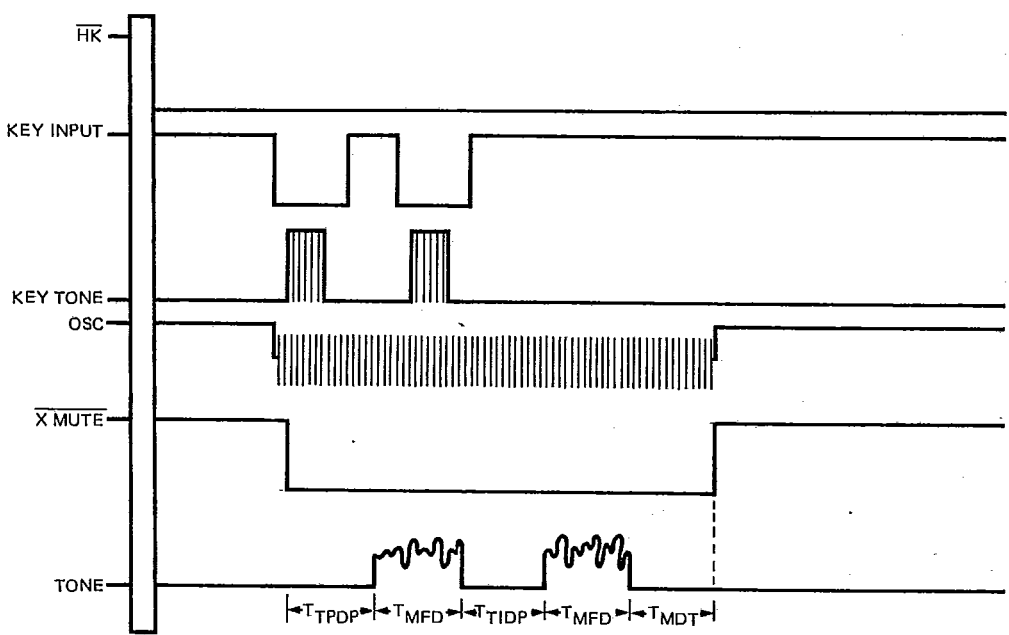

(3) NORMAL PULSE TO TONE MIXED DIALING VIA SLIDE SWITCH

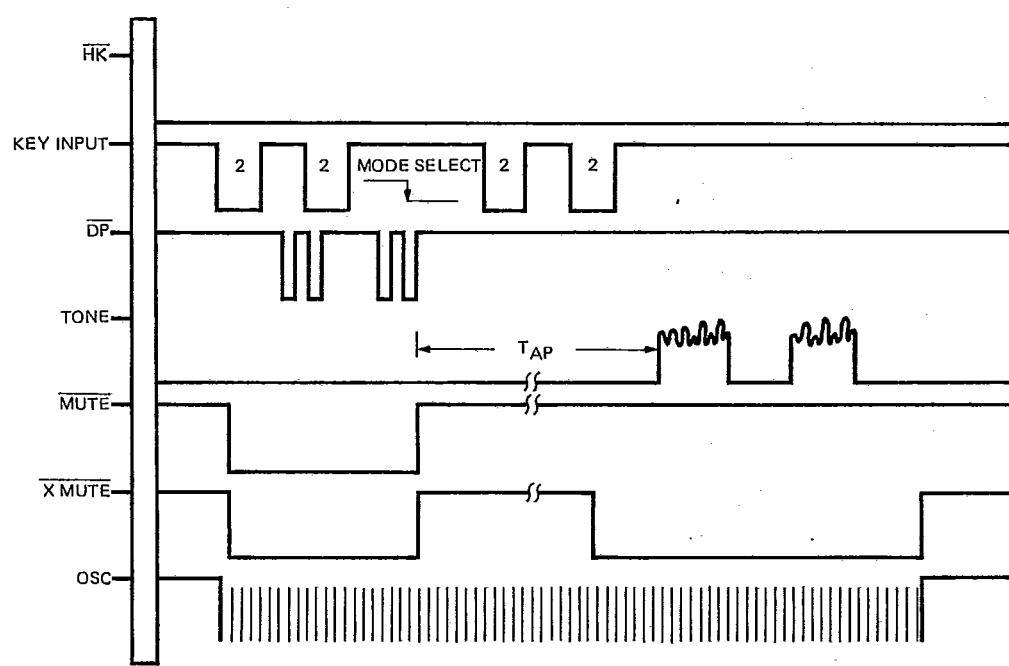





UM91260/61

T-75-07-07

Test Circuits

