

TOSHIBA Bipolar Linear Integrated Circuit Silicon Monolithic

TA7805F, TA78057F, TA7806F, TA7807F, TA7808F, TA7809F, TA7810F, TA7812F, TA7815F, TA7818F, TA7820F, TA7824F

Three Terminal Positive Voltage Regulators

5 V, 5.7 V, 6 V, 7 V, 8 V, 9 V, 10 V, 12 V, 15 V, 18 V, 20 V, 24 V

Features

- Suitable for CMOS, TTL, the power supply of the digital ICs
- Internal thermal overload protection.
- Internal short circuit current limiting.
- Maximum output current of 1 A.
- Packaged in POWER MOLD.

Pin Assignment

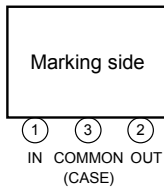

Marking

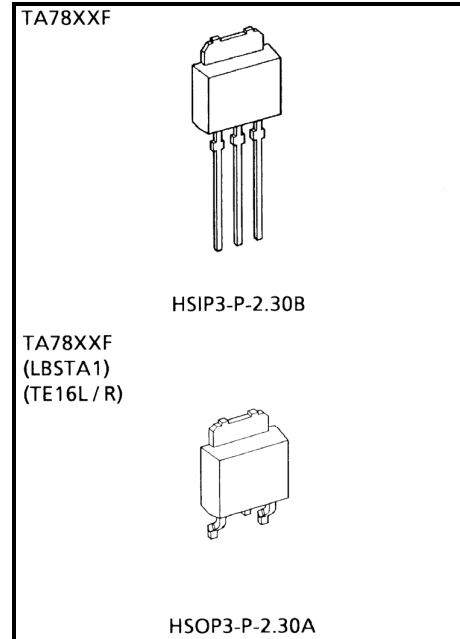
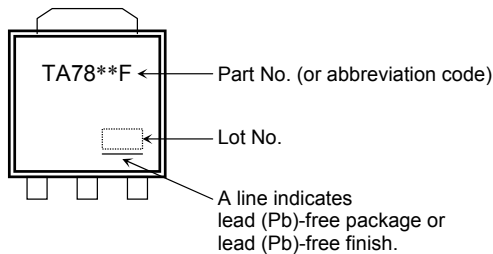

Weight

HSIP3-P-2.30B: 0.36 g (typ.)

HSOP3-P-2.30A: 0.36 g (typ.)

Equivalent Circuit

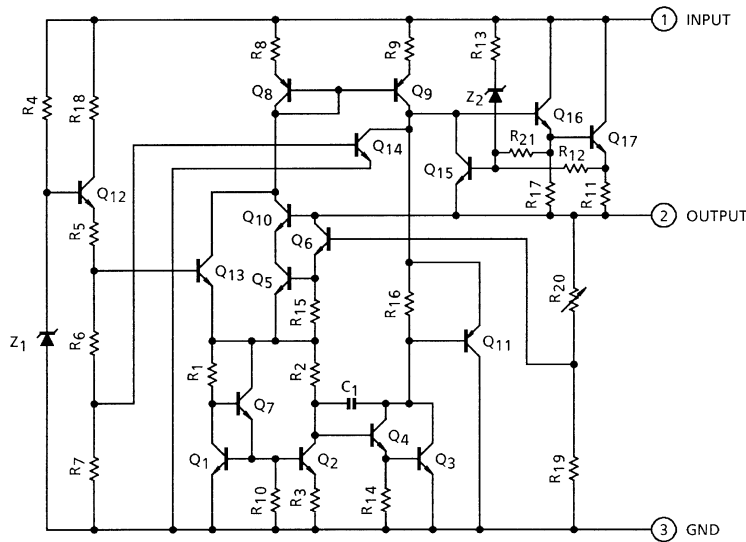

Absolute Maximum Ratings (Ta = 25°C)

Characteristics	Symbol	Rating	Unit			
Input voltage	V _{IN}	35	V			
		40				
		1		W		
		10				
		Operating temperature		T _{opr}	-30~85	°C
		Storage temperature		T _{stg}	-55~150	°C
		Junction temperature		T _j	150	°C
		Thermal resistance		R _{th(j-c)}	12.5	°C/W
				R _{th(j-a)}	125	

Note: Using continuously under heavy loads (e.g. the application of high temperature/current/voltage and the significant change in temperature, etc.) may cause this product to decrease in the reliability significantly even if the operating conditions (i.e. operating temperature/current/voltage, etc.) are within the absolute maximum ratings and the operating ranges.

Please design the appropriate reliability upon reviewing the Toshiba Semiconductor Reliability Handbook ("Handling Precautions"/Derating Concept and Methods) and individual reliability data (i.e. reliability test report and estimated failure rate, etc).

TA7805F

Electrical Characteristics

(Unless otherwise specified, $V_{IN} = 10\text{ V}$, $I_{OUT} = 500\text{ mA}$, $0^\circ\text{C} \leq T_j \leq 125^\circ\text{C}$)

Characteristics	Symbol	Test Circuit	Test Condition	Min	Typ.	Max	Unit	
Output voltage	V_{OUT}	1	$T_j = 25^\circ\text{C}$, $I_{OUT} = 100\text{ mA}$	4.8	5.0	5.2	V	
Line regulation	Reg-line	1	$T_j = 25^\circ\text{C}$	$7.0\text{ V} \leq V_{IN} \leq 25\text{ V}$	—	3	100	mV
				$8.0\text{ V} \leq V_{IN} \leq 12\text{ V}$	—	1	50	
Load regulation	Reg-load	1	$T_j = 25^\circ\text{C}$	$5\text{ mA} \leq I_{OUT} \leq 1.4\text{ A}$	—	15	100	mV
				$250\text{ mA} \leq I_{OUT} \leq 750\text{ mA}$	—	5	50	
Output voltage	V_{OUT}	1	$T_j = 25^\circ\text{C}$ $7.0\text{ V} \leq V_{IN} \leq 20\text{ V}$ $5.0\text{ mA} \leq I_{OUT} \leq 1.0\text{ A}$	4.75	—	5.25	V	
Quiescent current	I_B	1	$T_j = 25^\circ\text{C}$, $I_{OUT} = 5\text{ mA}$	—	4.2	8.0	mA	
Quiescent current change	ΔI_B	1	$7.0\text{ V} \leq V_{IN} \leq 25\text{ V}$, $I_{OUT} = 5\text{ mA}$, $T_j = 25^\circ\text{C}$	—	—	1.3	mA	
Output noise voltage	V_{NO}	2	$T_a = 25^\circ\text{C}$, $10\text{ Hz} \leq f \leq 100\text{ kHz}$ $I_{OUT} = 50\text{ mA}$	—	50	—	μV_{rms}	
Ripple rejection	R.R.	3	$f = 120\text{ Hz}$, $10\text{ V} \leq V_{IN} \leq 18\text{ V}$ $I_{OUT} = 50\text{ mA}$, $T_j = 25^\circ\text{C}$	57	73	—	dB	
Dropout voltage	V_D	1	$I_{OUT} = 1.0\text{ A}$, $T_j = 25^\circ\text{C}$	—	2.0	—	V	
Short circuit current limit	I_{SC}	1	$T_j = 25^\circ\text{C}$	—	1.6	—	A	
Average temperature coefficient of output voltage	T_{CVO}	1	$I_{OUT} = 5\text{ mA}$	—	-0.6	—	$\text{mV}/^\circ\text{C}$	

TA78057F

Electrical Characteristics

(Unless otherwise specified, $V_{IN} = 10.7\text{ V}$, $I_{OUT} = 500\text{ mA}$, $0^\circ\text{C} \leq T_j \leq 125^\circ\text{C}$)

Characteristics	Symbol	Test Circuit	Test Condition	Min	Typ.	Max	Unit	
Output voltage	V_{OUT}	1	$T_j = 25^\circ\text{C}$, $I_{OUT} = 100\text{ mA}$	5.47	5.7	5.93	V	
Line regulation	Reg-line	1	$T_j = 25^\circ\text{C}$	$7.7\text{ V} \leq V_{IN} \leq 25\text{ V}$	—	4	110	mV
				$8.7\text{ V} \leq V_{IN} \leq 12.7\text{ V}$	—	2	55	
Load regulation	Reg-load	1	$T_j = 25^\circ\text{C}$	$5\text{ mA} \leq I_{OUT} \leq 1.4\text{ A}$	—	15	110	mV
				$250\text{ mA} \leq I_{OUT} \leq 750\text{ mA}$	—	5	55	
Output voltage	V_{OUT}	1	$T_j = 25^\circ\text{C}$ $7.7\text{ V} \leq V_{IN} \leq 20.7\text{ V}$ $5.0\text{ mA} \leq I_{OUT} \leq 1.0\text{ A}$	5.42	—	5.98	V	
Quiescent current	I_B	1	$T_j = 25^\circ\text{C}$, $I_{OUT} = 5\text{ mA}$	—	4.3	8.0	mA	
Quiescent current change	ΔI_B	1	$7.7\text{ V} \leq V_{IN} \leq 25\text{ V}$, $I_{OUT} = 5\text{ mA}$, $T_j = 25^\circ\text{C}$	—	—	1.3	mA	
Output noise voltage	V_{NO}	2	$T_a = 25^\circ\text{C}$, $10\text{ Hz} \leq f \leq 100\text{ kHz}$ $I_{OUT} = 50\text{ mA}$	—	55	—	μV_{rms}	
Ripple rejection	R.R.	3	$f = 120\text{ Hz}$, $8.8\text{ V} \leq V_{IN} \leq 18.8\text{ V}$, $I_{OUT} = 50\text{ mA}$, $T_j = 25^\circ\text{C}$	56	72	—	dB	
Dropout voltage	V_D	1	$I_{OUT} = 1.0\text{ A}$, $T_j = 25^\circ\text{C}$	—	2.0	—	V	
Short circuit current limit	I_{SC}	1	$T_j = 25^\circ\text{C}$	—	1.5	—	A	
Average temperature coefficient of output voltage	T_{CVO}	1	$I_{OUT} = 5\text{ mA}$	—	-0.7	—	$\text{mV}/^\circ\text{C}$	

TA7806F

Electrical Characteristics

(Unless otherwise specified, $V_{IN} = 11\text{ V}$, $I_{OUT} = 500\text{ mA}$, $0^\circ\text{C} \leq T_j \leq 125^\circ\text{C}$)

Characteristics	Symbol	Test Circuit	Test Condition	Min	Typ.	Max	Unit	
Output voltage	V_{OUT}	1	$T_j = 25^\circ\text{C}$, $I_{OUT} = 100\text{ mA}$	5.75	6.0	6.25	V	
Line regulation	Reg-line	1	$T_j = 25^\circ\text{C}$	$8.0\text{ V} \leq V_{IN} \leq 25\text{ V}$	—	4	120	mV
				$9\text{ V} \leq V_{IN} \leq 13\text{ V}$	—	2	60	
Load regulation	Reg-load	1	$T_j = 25^\circ\text{C}$	$5\text{ mA} \leq I_{OUT} \leq 1.4\text{ A}$	—	15	120	mV
				$250\text{ mA} \leq I_{OUT} \leq 750\text{ mA}$	—	5	60	
Output voltage	V_{OUT}	1	$T_j = 25^\circ\text{C}$ $8\text{ V} \leq V_{IN} \leq 21\text{ V}$ $5.0\text{ mA} \leq I_{OUT} \leq 1.0\text{ A}$	5.7	—	6.3	V	
Quiescent current	I_B	1	$T_j = 25^\circ\text{C}$, $I_{OUT} = 5\text{ mA}$	—	4.3	8.0	mA	
Quiescent current change	ΔI_B	1	$8.0\text{ V} \leq V_{IN} \leq 25\text{ V}$, $I_{OUT} = 5\text{ mA}$, $T_j = 25^\circ\text{C}$	—	—	1.3	mA	
Output noise voltage	V_{NO}	2	$T_a = 25^\circ\text{C}$, $10\text{ Hz} \leq f \leq 100\text{ kHz}$ $I_{OUT} = 50\text{ mA}$	—	55	—	μV_{rms}	
Ripple rejection	R.R.	3	$f = 120\text{ Hz}$, $11\text{ V} \leq V_{IN} \leq 19\text{ V}$ $I_{OUT} = 50\text{ mA}$, $T_j = 25^\circ\text{C}$	56	72	—	dB	
Dropout voltage	V_D	1	$I_{OUT} = 1.0\text{ A}$, $T_j = 25^\circ\text{C}$	—	2.0	—	V	
Short circuit current limit	I_{SC}	1	$T_j = 25^\circ\text{C}$	—	1.5	—	A	
Average temperature coefficient of output voltage	T_{CVO}	1	$I_{OUT} = 5\text{ mA}$	—	-0.7	—	$\text{mV}/^\circ\text{C}$	

TA7807F

Electrical Characteristics

(Unless otherwise specified, $V_{IN} = 12\text{ V}$, $I_{OUT} = 500\text{ mA}$, $0^\circ\text{C} \leq T_j \leq 125^\circ\text{C}$)

Characteristics	Symbol	Test Circuit	Test Condition	Min	Typ.	Max	Unit	
Output voltage	V_{OUT}	1	$T_j = 25^\circ\text{C}$, $I_{OUT} = 100\text{ mA}$	6.72	7.0	7.28	V	
Line regulation	Reg-line	1	$T_j = 25^\circ\text{C}$	$9\text{ V} \leq V_{IN} \leq 25\text{ V}$	—	5	140	mV
				$10\text{ V} \leq V_{IN} \leq 14\text{ V}$	—	2	70	
Load regulation	Reg-load	1	$T_j = 25^\circ\text{C}$	$5\text{ mA} \leq I_{OUT} \leq 1.4\text{ A}$	—	15	140	mV
				$250\text{ mA} \leq I_{OUT} \leq 750\text{ mA}$	—	5	70	
Output voltage	V_{OUT}	1	$T_j = 25^\circ\text{C}$ $9\text{ V} \leq V_{IN} \leq 22\text{ V}$ $5.0\text{ mA} \leq I_{OUT} \leq 1.0\text{ A}$	6.65	—	7.35	V	
Quiescent current	I_B	1	$T_j = 25^\circ\text{C}$, $I_{OUT} = 5\text{ mA}$	—	4.3	8.0	mA	
Quiescent current change	ΔI_B	1	$9\text{ V} \leq V_{IN} \leq 25\text{ V}$, $I_{OUT} = 5\text{ mA}$, $T_j = 25^\circ\text{C}$	—	—	1.3	mA	
Output noise voltage	V_{NO}	2	$T_a = 25^\circ\text{C}$, $10\text{ Hz} \leq f \leq 100\text{ kHz}$ $I_{OUT} = 50\text{ mA}$	—	60	—	μV_{rms}	
Ripple rejection	R.R.	3	$f = 120\text{ Hz}$, $12\text{ V} \leq V_{IN} \leq 20\text{ V}$ $I_{OUT} = 50\text{ mA}$, $T_j = 25^\circ\text{C}$	54	70	—	dB	
Dropout voltage	V_D	1	$I_{OUT} = 1.0\text{ A}$, $T_j = 25^\circ\text{C}$	—	2.0	—	V	
Short circuit current limit	I_{SC}	1	$T_j = 25^\circ\text{C}$	—	1.3	—	A	
Average temperature coefficient of output voltage	T_{CVO}	1	$I_{OUT} = 5\text{ mA}$	—	-0.8	—	$\text{mV}/^\circ\text{C}$	

TA7808F

Electrical Characteristics

(Unless otherwise specified, $V_{IN} = 14\text{ V}$, $I_{OUT} = 500\text{ mA}$, $0^\circ\text{C} \leq T_j \leq 125^\circ\text{C}$)

Characteristics	Symbol	Test Circuit	Test Condition	Min	Typ.	Max	Unit	
Output voltage	V_{OUT}	1	$T_j = 25^\circ\text{C}$, $I_{OUT} = 100\text{ mA}$	7.7	8.0	8.3	V	
Line regulation	Reg-line	1	$T_j = 25^\circ\text{C}$	$10.5\text{ V} \leq V_{IN} \leq 25\text{ V}$	—	6	160	mV
				$11\text{ V} \leq V_{IN} \leq 17\text{ V}$	—	2	80	
Load regulation	Reg-load	1	$T_j = 25^\circ\text{C}$	$5\text{ mA} \leq I_{OUT} \leq 1.4\text{ A}$	—	12	160	mV
				$250\text{ mA} \leq I_{OUT} \leq 750\text{ mA}$	—	4	80	
Output voltage	V_{OUT}	1	$T_j = 25^\circ\text{C}$ $10.5\text{ V} \leq V_{IN} \leq 23\text{ V}$ $5.0\text{ mA} \leq I_{OUT} \leq 1.0\text{ A}$	7.6	—	8.4	V	
Quiescent current	I_B	1	$T_j = 25^\circ\text{C}$, $I_{OUT} = 5\text{ mA}$	—	4.3	8.0	mA	
Quiescent current change	ΔI_B	1	$10.5\text{ V} \leq V_{IN} \leq 25\text{ V}$, $I_{OUT} = 5\text{ mA}$, $T_j = 25^\circ\text{C}$	—	—	1.0	mA	
Output noise voltage	V_{NO}	2	$T_a = 25^\circ\text{C}$, $10\text{ Hz} \leq f \leq 100\text{ kHz}$ $I_{OUT} = 50\text{ mA}$	—	70	—	μV_{rms}	
Ripple rejection	R.R.	3	$f = 120\text{ Hz}$, $14\text{ V} \leq V_{IN} \leq 21.5\text{ V}$ $I_{OUT} = 50\text{ mA}$, $T_j = 25^\circ\text{C}$	53	69	—	dB	
Dropout voltage	V_D	1	$I_{OUT} = 1.0\text{ A}$, $T_j = 25^\circ\text{C}$	—	2.0	—	V	
Short circuit current limit	I_{SC}	1	$T_j = 25^\circ\text{C}$	—	1.1	—	A	
Average temperature coefficient of output voltage	T_{CVO}	1	$I_{OUT} = 5\text{ mA}$	—	-1.0	—	$\text{mV}/^\circ\text{C}$	

TA7809F

Electrical Characteristics

(Unless otherwise specified, $V_{IN} = 15\text{ V}$, $I_{OUT} = 500\text{ mA}$, $0^\circ\text{C} \leq T_j \leq 125^\circ\text{C}$)

Characteristics	Symbol	Test Circuit	Test Condition	Min	Typ.	Max	Unit	
Output voltage	V_{OUT}	1	$T_j = 25^\circ\text{C}$, $I_{OUT} = 100\text{ mA}$	8.64	9.0	9.36	V	
Line regulation	Reg-line	1	$T_j = 25^\circ\text{C}$	$11.5\text{ V} \leq V_{IN} \leq 26\text{ V}$	—	7.0	180	mV
				$13\text{ V} \leq V_{IN} \leq 19\text{ V}$	—	2.5	90	
Load regulation	Reg-load	1	$T_j = 25^\circ\text{C}$	$5\text{ mA} \leq I_{OUT} \leq 1.4\text{ A}$	—	12	180	mV
				$250\text{ mA} \leq I_{OUT} \leq 750\text{ mA}$	—	4	90	
Output voltage	V_{OUT}	1	$T_j = 25^\circ\text{C}$ $11.5\text{ V} \leq V_{IN} \leq 24\text{ V}$ $5.0\text{ mA} \leq I_{OUT} \leq 1.0\text{ A}$	8.55	—	9.45	V	
Quiescent current	I_B	1	$T_j = 25^\circ\text{C}$, $I_{OUT} = 5\text{ mA}$	—	4.3	8.0	mA	
Quiescent current change	ΔI_B	1	$11.5\text{ V} \leq V_{IN} \leq 26\text{ V}$, $I_{OUT} = 5\text{ mA}$, $T_j = 25^\circ\text{C}$	—	—	1.0	mA	
Output noise voltage	V_{NO}	2	$T_a = 25^\circ\text{C}$, $10\text{ Hz} \leq f \leq 100\text{ kHz}$ $I_{OUT} = 50\text{ mA}$	—	75	—	μV_{rms}	
Ripple rejection	R.R.	3	$f = 120\text{ Hz}$, $15\text{ V} \leq V_{IN} \leq 22.5\text{ V}$ $I_{OUT} = 50\text{ mA}$, $T_j = 25^\circ\text{C}$	51	67	—	dB	
Dropout voltage	V_D	1	$I_{OUT} = 1.0\text{ A}$, $T_j = 25^\circ\text{C}$	—	2.0	—	V	
Short circuit current limit	I_{SC}	1	$T_j = 25^\circ\text{C}$	—	1.0	—	A	
Average temperature coefficient of output voltage	T_{CVO}	1	$I_{OUT} = 5\text{ mA}$	—	-1.1	—	$\text{mV}/^\circ\text{C}$	

TA7810F

Electrical Characteristics

(Unless otherwise specified, $V_{IN} = 16\text{ V}$, $I_{OUT} = 500\text{ mA}$, $0^\circ\text{C} \leq T_j \leq 125^\circ\text{C}$)

Characteristics	Symbol	Test Circuit	Test Condition	Min	Typ.	Max	Unit	
Output voltage	V_{OUT}	1	$T_j = 25^\circ\text{C}$, $I_{OUT} = 100\text{ mA}$	9.6	10.0	10.4	V	
Line regulation	Reg-line	1	$T_j = 25^\circ\text{C}$	$12.5\text{ V} \leq V_{IN} \leq 27\text{ V}$	—	8	200	mV
				$14\text{ V} \leq V_{IN} \leq 20\text{ V}$	—	2.5	100	
Load regulation	Reg-load	1	$T_j = 25^\circ\text{C}$	$5\text{ mA} \leq I_{OUT} \leq 1.4\text{ A}$	—	12	200	mV
				$250\text{ mA} \leq I_{OUT} \leq 750\text{ mA}$	—	4	100	
Output voltage	V_{OUT}	1	$T_j = 25^\circ\text{C}$ $12.5\text{ V} \leq V_{IN} \leq 25\text{ V}$ $5.0\text{ mA} \leq I_{OUT} \leq 1.0\text{ A}$	9.5	—	10.5	V	
Quiescent current	I_B	1	$T_j = 25^\circ\text{C}$, $I_{OUT} = 5\text{ mA}$	—	4.3	8.0	mA	
Quiescent current change	ΔI_B	1	$12.5\text{ V} \leq V_{IN} \leq 27\text{ V}$, $I_{OUT} = 5\text{ mA}$, $T_j = 25^\circ\text{C}$	—	—	1.0	mA	
Output noise voltage	V_{NO}	2	$T_a = 25^\circ\text{C}$, $10\text{ Hz} \leq f \leq 100\text{ kHz}$ $I_{OUT} = 50\text{ mA}$	—	80	—	μV_{rms}	
Ripple rejection	R.R.	3	$f = 120\text{ Hz}$, $16\text{ V} \leq V_{IN} \leq 23.5\text{ V}$ $I_{OUT} = 50\text{ mA}$, $T_j = 25^\circ\text{C}$	50	66	—	dB	
Dropout voltage	V_D	1	$I_{OUT} = 1.0\text{ A}$, $T_j = 25^\circ\text{C}$	—	2.0	—	V	
Short circuit current limit	I_{SC}	1	$T_j = 25^\circ\text{C}$	—	0.9	—	A	
Average temperature coefficient of output voltage	T_{CVO}	1	$I_{OUT} = 5\text{ mA}$	—	-1.3	—	$\text{mV}/^\circ\text{C}$	

TA7812F

Electrical Characteristics

(Unless otherwise specified, $V_{IN} = 19\text{ V}$, $I_{OUT} = 500\text{ mA}$, $0^\circ\text{C} \leq T_j \leq 125^\circ\text{C}$)

Characteristics	Symbol	Test Circuit	Test Condition	Min	Typ.	Max	Unit	
Output voltage	V_{OUT}	1	$T_j = 25^\circ\text{C}$, $I_{OUT} = 100\text{ mA}$	11.5	12.0	12.5	V	
Line regulation	Reg-line	1	$T_j = 25^\circ\text{C}$	$14.5\text{ V} \leq V_{IN} \leq 30\text{ V}$	—	10	240	mV
				$16\text{ V} \leq V_{IN} \leq 22\text{ V}$	—	3	120	
Load regulation	Reg-load	1	$T_j = 25^\circ\text{C}$	$5\text{ mA} \leq I_{OUT} \leq 1.4\text{ A}$	—	12	240	mV
				$250\text{ mA} \leq I_{OUT} \leq 750\text{ mA}$	—	4	120	
Output voltage	V_{OUT}	1	$T_j = 25^\circ\text{C}$ $14.5\text{ V} \leq V_{IN} \leq 27\text{ V}$ $5.0\text{ mA} \leq I_{OUT} \leq 1.0\text{ A}$	11.4	—	12.6	V	
Quiescent current	I_B	1	$T_j = 25^\circ\text{C}$, $I_{OUT} = 5\text{ mA}$	—	4.3	8.0	mA	
Quiescent current change	ΔI_B	1	$14.5\text{ V} \leq V_{IN} \leq 30\text{ V}$, $I_{OUT} = 5\text{ mA}$, $T_j = 25^\circ\text{C}$	—	—	1.0	mA	
Output noise voltage	V_{NO}	2	$T_a = 25^\circ\text{C}$, $10\text{ Hz} \leq f \leq 100\text{ kHz}$ $I_{OUT} = 50\text{ mA}$	—	90	—	μV_{rms}	
Ripple rejection	R.R.	3	$f = 120\text{ Hz}$, $19\text{ V} \leq V_{IN} \leq 25\text{ V}$ $I_{OUT} = 50\text{ mA}$, $T_j = 25^\circ\text{C}$	50	66	—	dB	
Dropout voltage	V_D	1	$I_{OUT} = 1.0\text{ A}$, $T_j = 25^\circ\text{C}$	—	2.0	—	V	
Short circuit current limit	I_{SC}	1	$T_j = 25^\circ\text{C}$	—	0.7	—	A	
Average temperature coefficient of output voltage	T_{CVO}	1	$I_{OUT} = 5\text{ mA}$	—	-1.6	—	$\text{mV}/^\circ\text{C}$	

TA7815F

Electrical Characteristics

(Unless otherwise specified, $V_{IN} = 23\text{ V}$, $I_{OUT} = 500\text{ mA}$, $0^\circ\text{C} \leq T_j \leq 125^\circ\text{C}$)

Characteristics	Symbol	Test Circuit	Test Condition	Min	Typ.	Max	Unit	
Output voltage	V_{OUT}	1	$T_j = 25^\circ\text{C}$, $I_{OUT} = 100\text{ mA}$	14.4	15.0	15.6	V	
Line regulation	Reg-line	1	$T_j = 25^\circ\text{C}$	$17.5\text{ V} \leq V_{IN} \leq 30\text{ V}$	—	11	300	mV
				$20\text{ V} \leq V_{IN} \leq 26\text{ V}$	—	3	150	
Load regulation	Reg-load	1	$T_j = 25^\circ\text{C}$	$5\text{ mA} \leq I_{OUT} \leq 1.4\text{ A}$	—	12	300	mV
				$250\text{ mA} \leq I_{OUT} \leq 750\text{ mA}$	—	4	150	
Output voltage	V_{OUT}	1	$T_j = 25^\circ\text{C}$ $17.5\text{ V} \leq V_{IN} \leq 30\text{ V}$ $5.0\text{ mA} \leq I_{OUT} \leq 1.0\text{ A}$	14.25	—	15.75	V	
Quiescent current	I_B	1	$T_j = 25^\circ\text{C}$, $I_{OUT} = 5\text{ mA}$	—	4.4	8.0	mA	
Quiescent current change	ΔI_B	1	$17.5\text{ V} \leq V_{IN} \leq 30\text{ V}$, $I_{OUT} = 5\text{ mA}$, $T_j = 25^\circ\text{C}$	—	—	1.0	mA	
Output noise voltage	V_{NO}	2	$T_a = 25^\circ\text{C}$, $10\text{ Hz} \leq f \leq 100\text{ kHz}$ $I_{OUT} = 50\text{ mA}$	—	110	—	μV_{rms}	
Ripple rejection	R.R.	3	$f = 120\text{ Hz}$, $23\text{ V} \leq V_{IN} \leq 28.5\text{ V}$ $I_{OUT} = 50\text{ mA}$, $T_j = 25^\circ\text{C}$	49	65	—	dB	
Dropout voltage	V_D	1	$I_{OUT} = 1.0\text{ A}$, $T_j = 25^\circ\text{C}$	—	2.0	—	V	
Short circuit current limit	I_{SC}	1	$T_j = 25^\circ\text{C}$	—	0.5	—	A	
Average temperature coefficient of output voltage	T_{CVO}	1	$I_{OUT} = 5\text{ mA}$	—	-2.0	—	$\text{mV}/^\circ\text{C}$	

TA7818F

Electrical Characteristics

(Unless otherwise specified, $V_{IN} = 27\text{ V}$, $I_{OUT} = 500\text{ mA}$, $0^\circ\text{C} \leq T_j \leq 125^\circ\text{C}$)

Characteristics	Symbol	Test Circuit	Test Condition	Min	Typ.	Max	Unit	
Output voltage	V_{OUT}	1	$T_j = 25^\circ\text{C}$, $I_{OUT} = 100\text{ mA}$	17.3	18.0	18.7	V	
Line regulation	Reg-line	1	$T_j = 25^\circ\text{C}$	$21\text{ V} \leq V_{IN} \leq 33\text{ V}$	—	13	360	mV
				$24\text{ V} \leq V_{IN} \leq 30\text{ V}$	—	4	180	
Load regulation	Reg-load	1	$T_j = 25^\circ\text{C}$	$5\text{ mA} \leq I_{OUT} \leq 1.4\text{ A}$	—	12	360	mV
				$250\text{ mA} \leq I_{OUT} \leq 750\text{ mA}$	—	4	180	
Output voltage	V_{OUT}	1	$T_j = 25^\circ\text{C}$ $21\text{ V} \leq V_{IN} \leq 33\text{ V}$ $5.0\text{ mA} \leq I_{OUT} \leq 1.0\text{ A}$	17.1	—	18.9	V	
Quiescent current	I_B	1	$T_j = 25^\circ\text{C}$, $I_{OUT} = 5\text{ mA}$	—	4.5	8.0	mA	
Quiescent current change	ΔI_B	1	$21\text{ V} \leq V_{IN} \leq 33\text{ V}$, $I_{OUT} = 5\text{ mA}$, $T_j = 25^\circ\text{C}$	—	—	1.0	mA	
Output noise voltage	V_{NO}	2	$T_a = 25^\circ\text{C}$, $10\text{ Hz} \leq f \leq 100\text{ kHz}$ $I_{OUT} = 50\text{ mA}$	—	125	—	μV_{rms}	
Ripple rejection	R.R.	3	$f = 120\text{ Hz}$, $27\text{ V} \leq V_{IN} \leq 32\text{ V}$ $I_{OUT} = 50\text{ mA}$, $T_j = 25^\circ\text{C}$	47	63	—	dB	
Dropout voltage	V_D	1	$I_{OUT} = 1.0\text{ A}$, $T_j = 25^\circ\text{C}$	—	2.0	—	V	
Short circuit current limit	I_{SC}	1	$T_j = 25^\circ\text{C}$	—	0.4	—	A	
Average temperature coefficient of output voltage	T_{CVO}	1	$I_{OUT} = 5\text{ mA}$	—	-2.5	—	$\text{mV}/^\circ\text{C}$	

TA7820F

Electrical Characteristics

(Unless otherwise specified, $V_{IN} = 29\text{ V}$, $I_{OUT} = 500\text{ mA}$, $0^\circ\text{C} \leq T_j \leq 125^\circ\text{C}$)

Characteristics	Symbol	Test Circuit	Test Condition	Min	Typ.	Max	Unit	
Output voltage	V_{OUT}	1	$T_j = 25^\circ\text{C}$, $I_{OUT} = 100\text{ mA}$	19.2	20.0	20.8	V	
Line regulation	Reg-line	1	$T_j = 25^\circ\text{C}$	$23\text{ V} \leq V_{IN} \leq 35\text{ V}$	—	15	400	mV
				$26\text{ V} \leq V_{IN} \leq 32\text{ V}$	—	5	200	
Load regulation	Reg-load	1	$T_j = 25^\circ\text{C}$	$5\text{ mA} \leq I_{OUT} \leq 1.4\text{ A}$	—	12	400	mV
				$250\text{ mA} \leq I_{OUT} \leq 750\text{ mA}$	—	4	200	
Output voltage	V_{OUT}	1	$T_j = 25^\circ\text{C}$ $23\text{ V} \leq V_{IN} \leq 35\text{ V}$ $5.0\text{ mA} \leq I_{OUT} \leq 1.0\text{ A}$	19.0	—	21.0	V	
Quiescent current	I_B	1	$T_j = 25^\circ\text{C}$, $I_{OUT} = 5\text{ mA}$	—	4.6	8.0	mA	
Quiescent current change	ΔI_B	1	$23\text{ V} \leq V_{IN} \leq 35\text{ V}$, $I_{OUT} = 5\text{ mA}$, $T_j = 25^\circ\text{C}$	—	—	1.0	mA	
Output noise voltage	V_{NO}	2	$T_a = 25^\circ\text{C}$, $10\text{ Hz} \leq f \leq 100\text{ kHz}$ $I_{OUT} = 50\text{ mA}$	—	135	—	μV_{rms}	
Ripple rejection	R.R.	3	$f = 120\text{ Hz}$, $29\text{ V} \leq V_{IN} \leq 34\text{ V}$ $I_{OUT} = 50\text{ mA}$, $T_j = 25^\circ\text{C}$	45	61	—	dB	
Dropout voltage	V_D	1	$I_{OUT} = 1.0\text{ A}$, $T_j = 25^\circ\text{C}$	—	2.0	—	V	
Short circuit current limit	I_{SC}	1	$T_j = 25^\circ\text{C}$	—	0.4	—	A	
Average temperature coefficient of output voltage	T_{CVO}	1	$I_{OUT} = 5\text{ mA}$	—	-3.0	—	$\text{mV}/^\circ\text{C}$	

TA7824F

Electrical Characteristics

(Unless otherwise specified, $V_{IN} = 33\text{ V}$, $I_{OUT} = 500\text{ mA}$, $0^\circ\text{C} \leq T_j \leq 125^\circ\text{C}$)

Characteristics	Symbol	Test Circuit	Test Condition	Min	Typ.	Max	Unit	
Output voltage	V_{OUT}	1	$T_j = 25^\circ\text{C}$, $I_{OUT} = 100\text{ mA}$	23.0	24.0	25.0	V	
Line regulation	Reg-line	1	$T_j = 25^\circ\text{C}$	$27\text{ V} \leq V_{IN} \leq 38\text{ V}$	—	18	480	mV
				$30\text{ V} \leq V_{IN} \leq 36\text{ V}$	—	6	240	
Load regulation	Reg-load	1	$T_j = 25^\circ\text{C}$	$5\text{ mA} \leq I_{OUT} \leq 1.4\text{ A}$	—	12	480	mV
				$250\text{ mA} \leq I_{OUT} \leq 750\text{ mA}$	—	4	240	
Output voltage	V_{OUT}	1	$T_j = 25^\circ\text{C}$ $27\text{ V} \leq V_{IN} \leq 38\text{ V}$ $5.0\text{ mA} \leq I_{OUT} \leq 1.0\text{ A}$	22.8	—	25.2	V	
Quiescent current	I_B	1	$T_j = 25^\circ\text{C}$, $I_{OUT} = 5\text{ mA}$	—	4.6	8.0	mA	
Quiescent current change	ΔI_B	1	$27\text{ V} \leq V_{IN} \leq 38\text{ V}$, $I_{OUT} = 5\text{ mA}$, $T_j = 25^\circ\text{C}$	—	—	1.0	mA	
Output noise voltage	V_{NO}	2	$T_a = 25^\circ\text{C}$, $10\text{ Hz} \leq f \leq 100\text{ kHz}$ $I_{OUT} = 50\text{ mA}$	—	150	—	μV_{rms}	
Ripple rejection	R.R.	3	$f = 120\text{ Hz}$, $33\text{ V} \leq V_{IN} \leq 38\text{ V}$ $I_{OUT} = 50\text{ mA}$, $T_j = 25^\circ\text{C}$	45	61	—	dB	
Dropout voltage	V_D	1	$I_{OUT} = 1.0\text{ A}$, $T_j = 25^\circ\text{C}$	—	2.0	—	V	
Short circuit current limit	I_{SC}	1	$T_j = 25^\circ\text{C}$	—	0.3	—	A	
Average temperature coefficient of output voltage	T_{CVO}	1	$I_{OUT} = 5\text{ mA}$	—	-3.5	—	$\text{mV}/^\circ\text{C}$	

Test Circuit 1/Standard Application Circuit

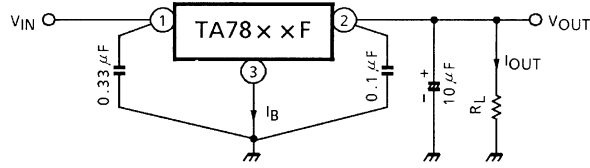

Test Circuit 2

V_{NO}

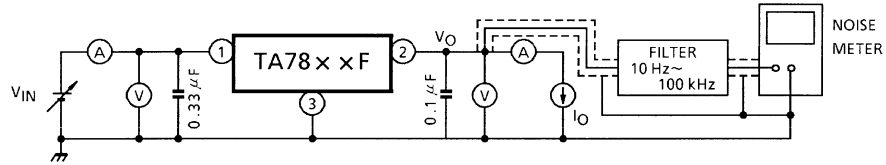

Test Circuit 3

R.R.

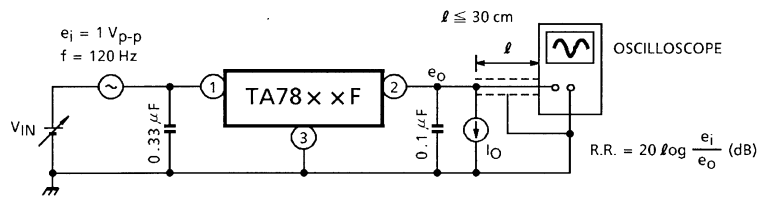

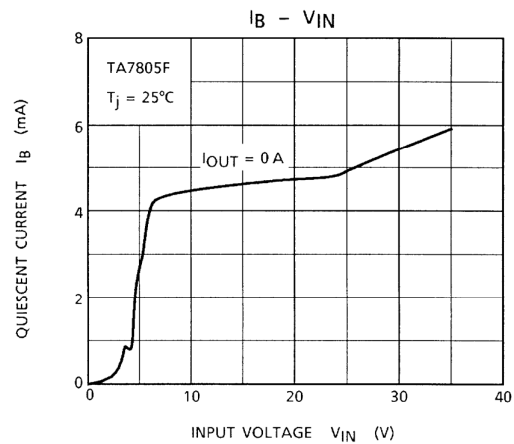
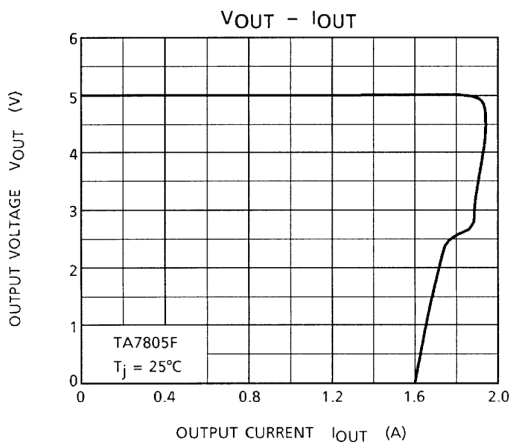
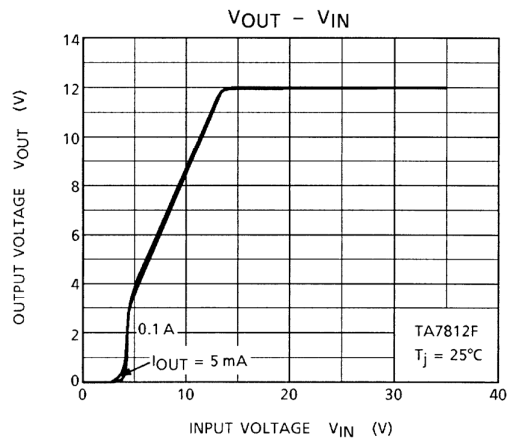
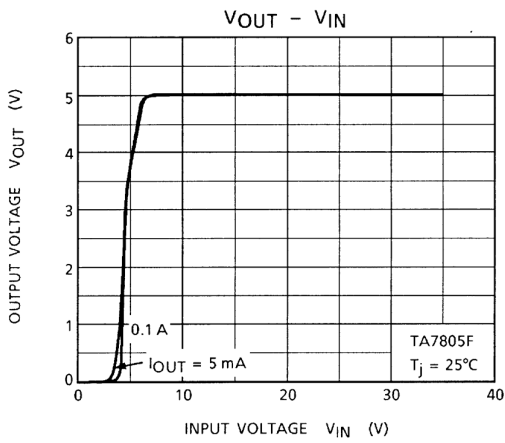
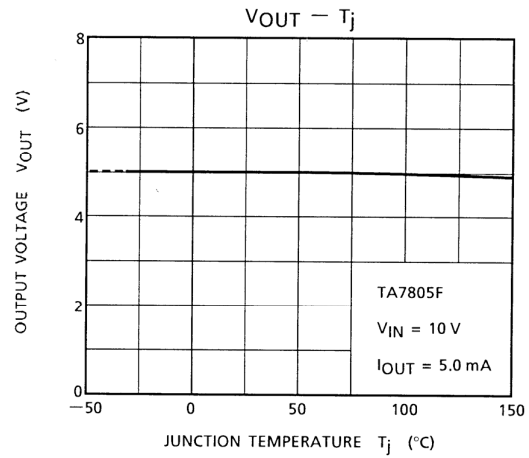
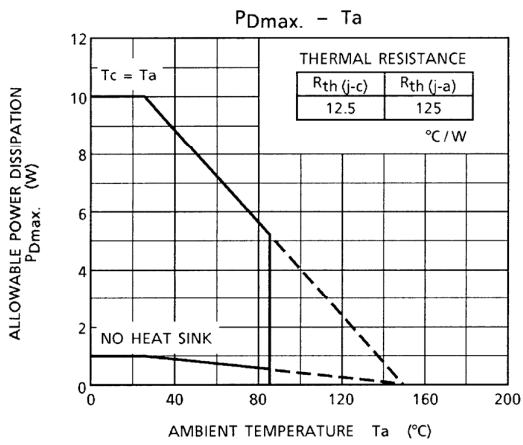

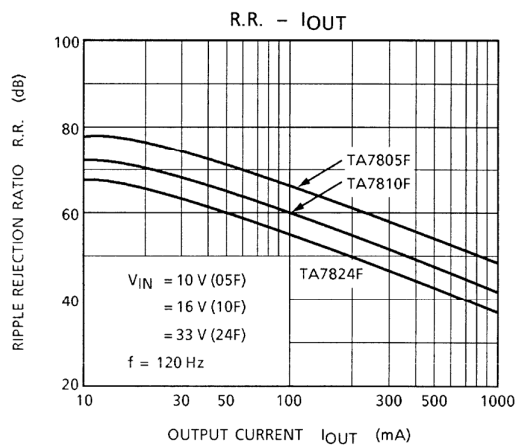
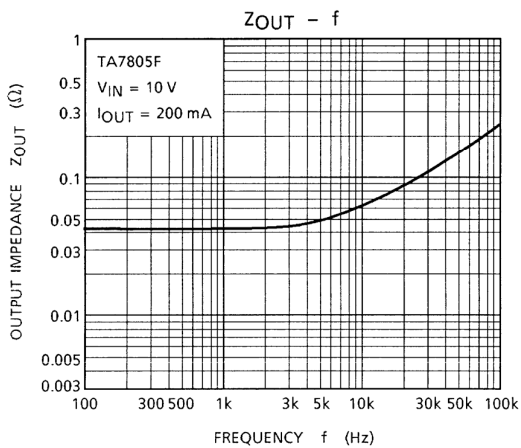
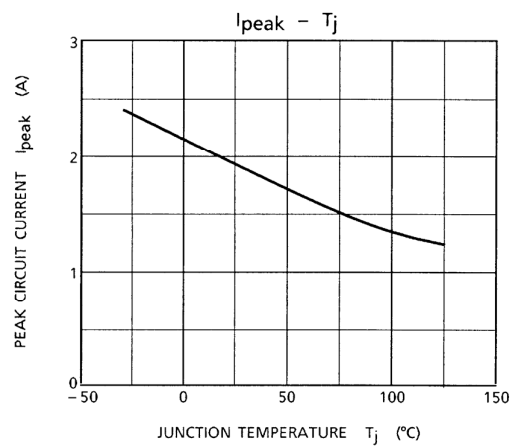
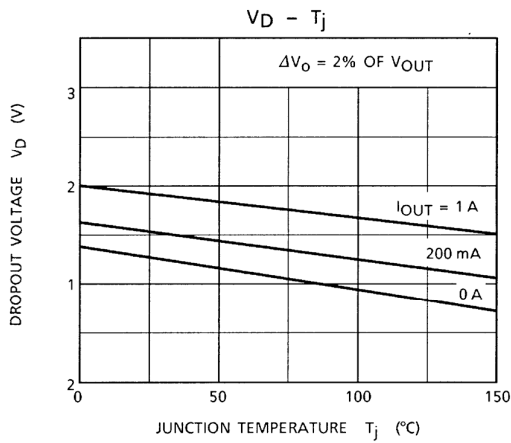
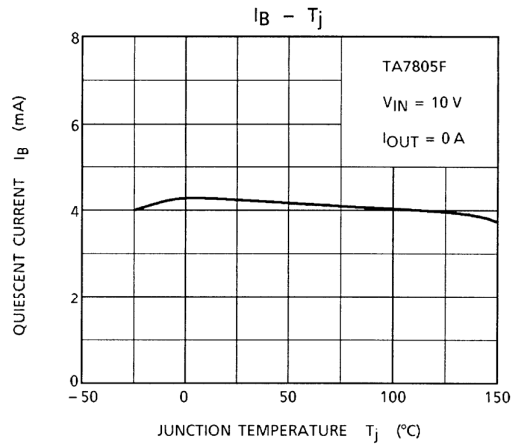
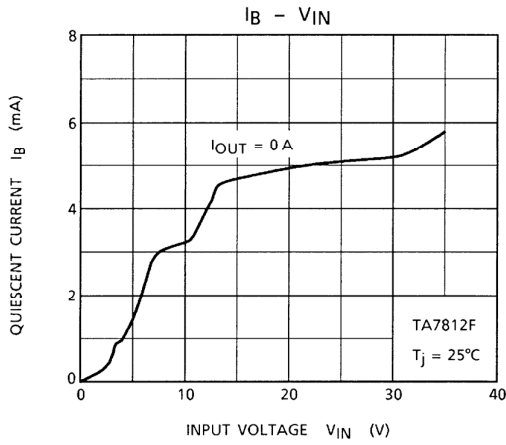

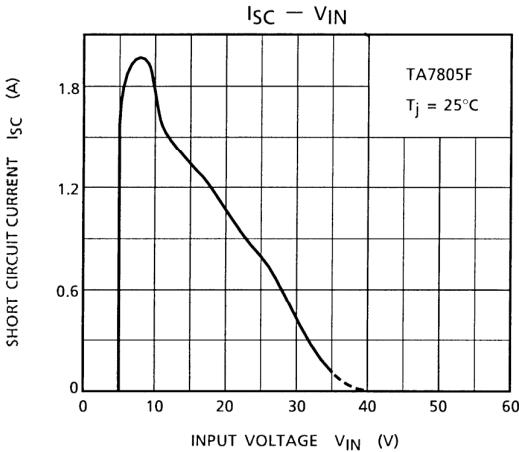

Precautions on Application

- (1) In regard to GND, be careful not to apply a negative voltage to the input/output terminal. Further, special care is necessary in the case of a voltage boost application.
- (2) If a surge voltage exceeding the absolute maximum rating is applied to the input terminal or if a voltage in excess of the input terminal voltage is applied to the output terminal, the circuit may be destroyed.

Particular care is necessary in the case of the latter.

Circuit destruction may also occur if the input terminal shorts to GND in a state of normal operation, causing the output terminal voltage to exceed the input voltage (GND potential) and the electrical charge of the chemical capacitor connected to the output terminal to flow into the input side.

Where these risks exist, take steps such as connecting zener and general silicon diodes to the circuit, as shown in the figure below.

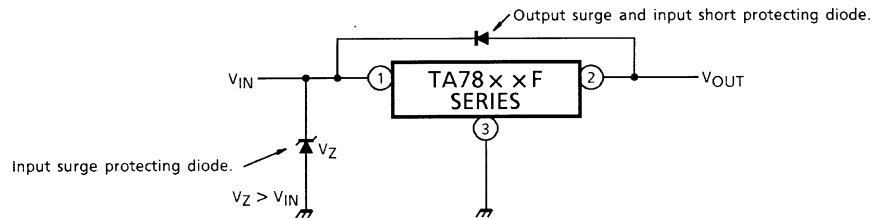

- (3) When the input voltage is too high, the power dissipation of the three-terminal regulator, which is a series regulator, increases, causing the junction temperature to rise. In such a case, it is recommended to reduce the power dissipation, and hence the junction temperature, by inserting a power-limiting resistor R_{SD} in the input terminal.

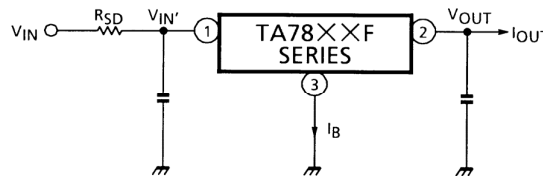

The power dissipation P_D of the IC is expressed in the following equation.

$$P_D = (V_{IN'} - V_{OUT}) \cdot I_{OUT} + V_{IN'} \cdot I_B$$

Reducing $V_{IN'}$ below the lowest voltage necessary for the IC will cause ripple, deterioration in output regulation and, in certain circumstances, parasitic oscillation.

To determine the resistance value of R_{SD} , design with a margin, referring to the following equation.

$$R_{SD} < \frac{V_{IN} - V_{IN'}}{I_{OUT} + I_B}$$

- (4) Be sure to connect a capacitor near the input terminal and output terminal between both terminals and GND. The capacitances should be determined experimentally because they depend on PCB patterns. In particular, adequate investigation should be made to ensure there is no problem even in high or low temperatures.

- (5) The molded plastic portion of this unit, measuring 5.5 mm (L) by 6.8 mm (W) by 2.5 mm (T), is more compact compared to its equivalent TO-220.

The GND fin extends directly out of the main body, and can be soldered directly to the ceramic circuit board for significant increase in power dissipation.

To obtain high reliability in the heat sink design of the regulator IC, it is generally required to derate more than 20% of maximum junction temperature (T_j max).

Further, full consideration should be given to the installation of IC on a heat sink.

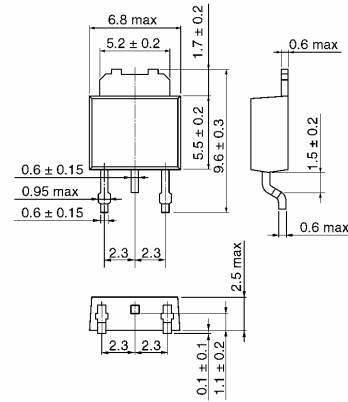

Application Circuits

(1) Voltage boost regulator

- (a) Voltage boost by use of zener diode

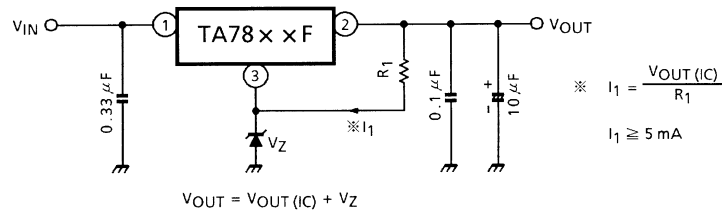

- (b) Voltage boost by use of resistor

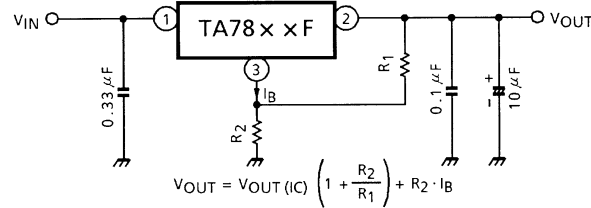

- (c) Adjustable output regulator

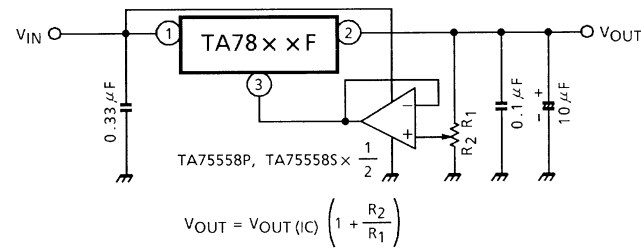

(2) Current boost regulator

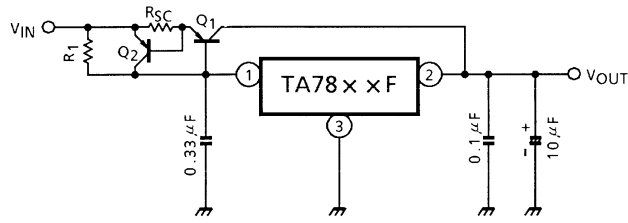

Heat sink is needed for Q₁.

$$R_1 \cong \frac{V_{BE1}}{I_B \text{ MAX}}$$

where,

V_{BE1} : V_{BE} of external transistor Q₁.
 I_B MAX : Quiescent current of IC.

$$R_{SC} = \frac{V_{BE2}}{I_{SC}}$$

where,

I_{SC} : Short-circuit current.

Package Dimensions

HSIP3-P-2.30B

Unit : mm

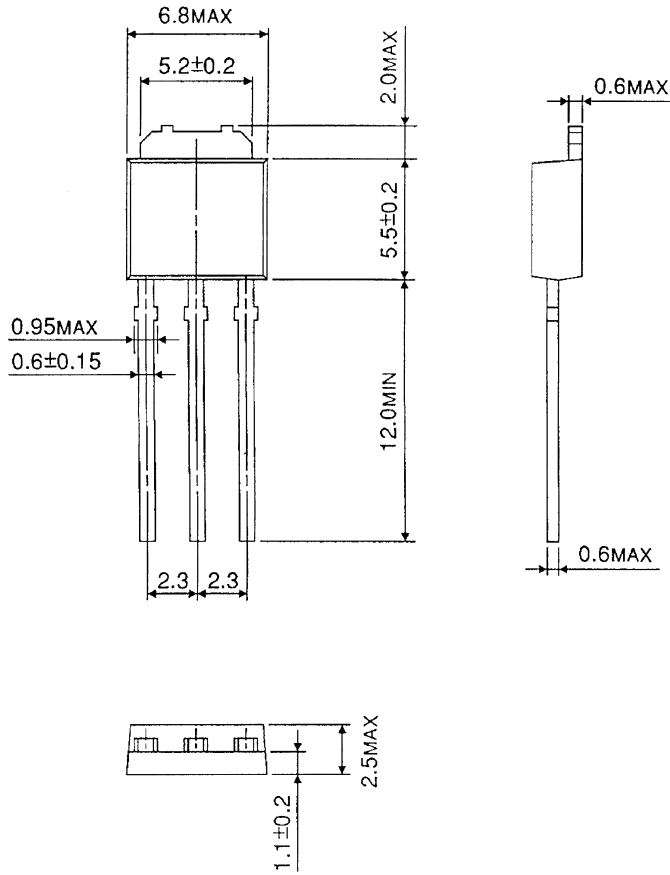

Weight : 0.36 g (Typ.)

Package Dimensions

HSOP3-P-2.30A

Unit: mm

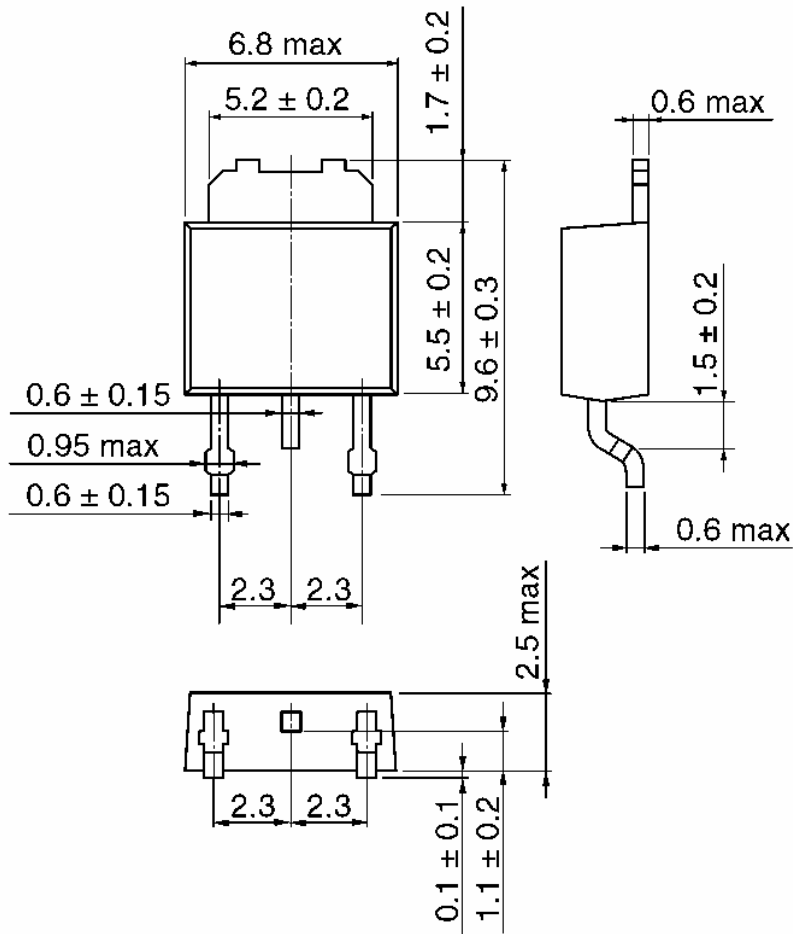

Weight: 0.36 g (typ.)

RESTRICTIONS ON PRODUCT USE

20070701-EN

- The information contained herein is subject to change without notice.
- TOSHIBA is continually working to improve the quality and reliability of its products. Nevertheless, semiconductor devices in general can malfunction or fail due to their inherent electrical sensitivity and vulnerability to physical stress. It is the responsibility of the buyer, when utilizing TOSHIBA products, to comply with the standards of safety in making a safe design for the entire system, and to avoid situations in which a malfunction or failure of such TOSHIBA products could cause loss of human life, bodily injury or damage to property.
In developing your designs, please ensure that TOSHIBA products are used within specified operating ranges as set forth in the most recent TOSHIBA products specifications. Also, please keep in mind the precautions and conditions set forth in the "Handling Guide for Semiconductor Devices," or "TOSHIBA Semiconductor Reliability Handbook" etc.
- The TOSHIBA products listed in this document are intended for usage in general electronics applications (computer, personal equipment, office equipment, measuring equipment, industrial robotics, domestic appliances, etc.). These TOSHIBA products are neither intended nor warranted for usage in equipment that requires extraordinarily high quality and/or reliability or a malfunction or failure of which may cause loss of human life or bodily injury ("Unintended Usage"). Unintended Usage include atomic energy control instruments, airplane or spaceship instruments, transportation instruments, traffic signal instruments, combustion control instruments, medical instruments, all types of safety devices, etc.. Unintended Usage of TOSHIBA products listed in this document shall be made at the customer's own risk.
- The products described in this document shall not be used or embedded to any downstream products of which manufacture, use and/or sale are prohibited under any applicable laws and regulations.
- The information contained herein is presented only as a guide for the applications of our products. No responsibility is assumed by TOSHIBA for any infringements of patents or other rights of the third parties which may result from its use. No license is granted by implication or otherwise under any patents or other rights of TOSHIBA or the third parties.
- Please contact your sales representative for product-by-product details in this document regarding RoHS compatibility. Please use these products in this document in compliance with all applicable laws and regulations that regulate the inclusion or use of controlled substances. Toshiba assumes no liability for damage or losses occurring as a result of noncompliance with applicable laws and regulations.