

**GaAs SPDT Switch,  
0.05 - 3.0 GHz**

**SW-485  
V3**

**Features**

- Low Insertion Loss: 0.3 dB Typ. @ 2.4 GHz
- Isolation: 21 dB @ 2.4 GHz
- Low Power Consumption: <5  $\mu$ A @ +2.3V
- Low Cost Plastic SOT-363 Package

**Description**

M/A-COM's SW-485 is a GaAs PHEMT MMIC SPDT switch in a low cost SC-70 (SOT-363) surface mount plastic package. The SW-485 is ideally suited for applications where very small size and low cost are required. Typical applications are dual band systems where switching between small signal components are required such as filter banks, single-band LNAs, converters, etc. This part can be used for low power, low loss requirements in all systems operating up to 3 GHz, including PCS, GSM, DCS, Blue Tooth, and other Rx chain applications.

The SW-485 is fabricated using a 0.5 micron gate length GaAs PHEMT process. The process features full passivation for performance and reliability.

**Ordering Information**

Part Number	Package
SW-485	Bulk Packaging
SW-485TR-3000	3000 piece reel
SW-485SMB	Sample Board (Includes 5 Samples)

Note: Reference Application Note M513 for reel size information.

**Truth Table <sup>1</sup>**

Mode (Control)	Control V1	Control V2	RFC-RF1	RFC-RF2
Positive <sup>1</sup>	0 $\pm$ 0.2V +2.3 to +5V	+2.3 to +5V 0 $\pm$ 0.2V	On Off	Off On

1. External DC blocking capacitors are required on all RF ports.

**Functional Schematic**

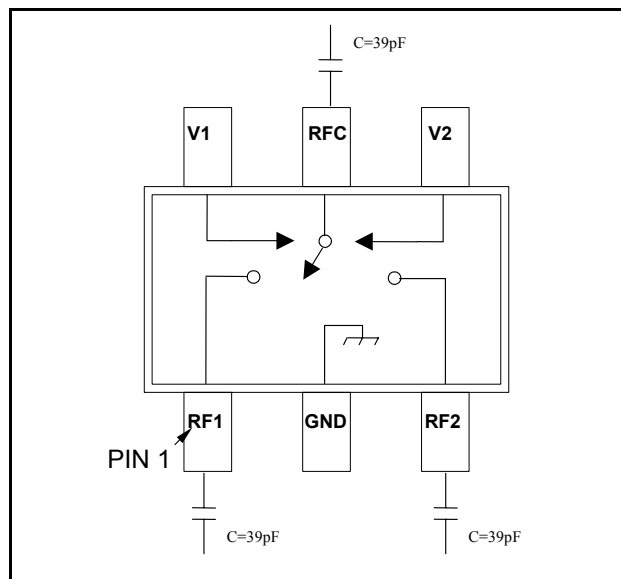

**Pin Configuration**

Pin No.	Function	Description
1	RF1	RF Port 1
2	GND	Ground
3	RF2	RF Port 2
4	V2	Control 2
5	RFC	RF Input
6	V1	Control 1

**Absolute Maximum Ratings<sup>2</sup>**

Parameter	Absolute Maximum
Input Power (0.5 - 3.0 GHz) 3 V Control 5 V Control	+32 dBm +34 dBm
Operating Voltage	+8.5 volts
Operating Temperature	-40°C to +85°C
Storage Temperature	-65°C to +150°C

2. Exceeding any one or combination of these limits may cause permanent damage to this device.

**GaAs SPDT Switch,  
0.05 - 3.0 GHz**

**SW-485  
V3**

**Electrical Specifications:  $T_A = 25^\circ\text{C}$ ,  $Z_0 = 50 \Omega$  <sup>3</sup>**

Parameter	Test Conditions	Units	Min	Typ	Max
Insertion Loss	0.05 - 1.0 GHz	dB	—	0.25	0.40
	0.05 - 3.0 GHz	dB	—	0.35	0.55
Isolation	0.05 - 1.0 GHz	dB	20	23	—
	0.05 - 3.0 GHz	dB	20	21	—
VSWR	0.05 - 3.0 GHz	Ratio	—	1.1:1	1.2:1
IP2	Two Tone +5 dBm, 5 MHz Spacing, >50 MHz	dBm	—	90	—
IP3	Two Tone +5 dBm, 5 MHz Spacing, >50 MHz	dBm	—	46	—
P1dB	$V_c = 0.2\text{V}/2.5\text{V}$	dBm	—	21	—
	$V_c = 0.2\text{V}/3.0\text{V}$	dBm	—	25	—
Trise, Tfall	10% to 90% RF and 90% to 10% RF	nS	—	35	—
Ton, Toff	—	nS	—	40	—
Transients	—	mV	—	10	—

3. Insertion loss can be optimized by varying the DC blocking capacitor value, e.g. 1000 pF for 100 MHz - 1 GHz, 39 pF for 0.5 GHz - 3 GHz.

**SC-70 (SOT-363) Plastic Package**

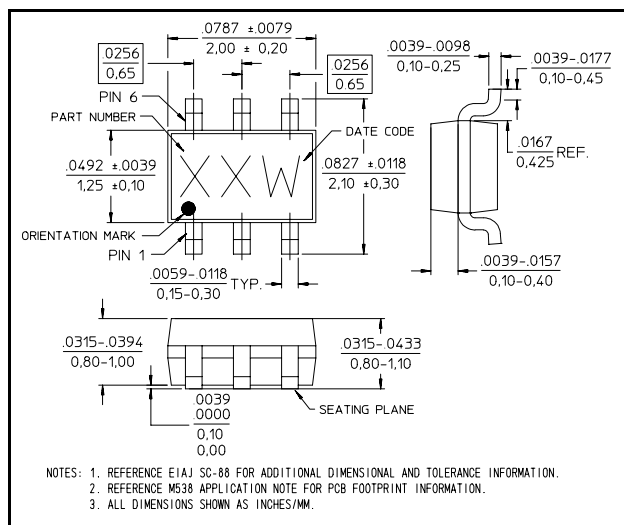

**Handling Procedures**

Please observe the following precautions to avoid damage:

**Static Sensitivity**

Gallium Arsenide Integrated Circuits are sensitive to electrostatic discharge (ESD) and can be damaged by static electricity. Proper ESD control techniques should be used when handling these devices.

**Typical Performance Curves**

**Insertion Loss, 39 pF**

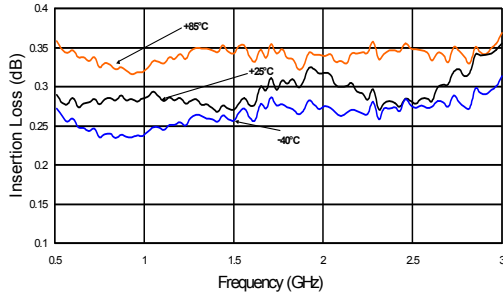

**Insertion Loss, 1000 pF**

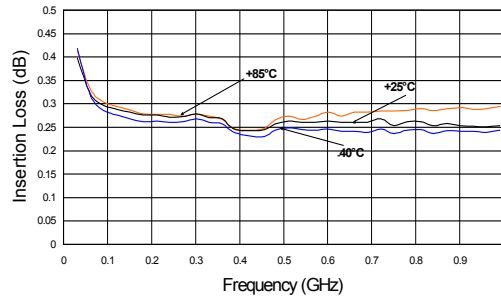

**Isolation, 39 pF**

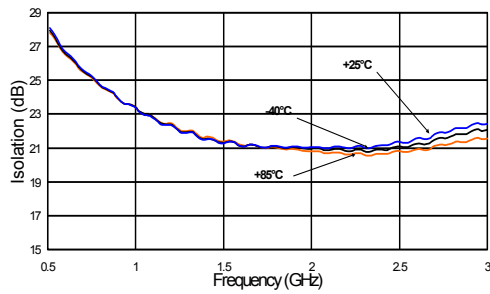

**Isolation, 1000 pF**

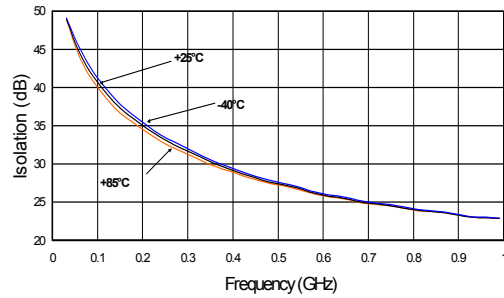

**VSWR, 39 pF**

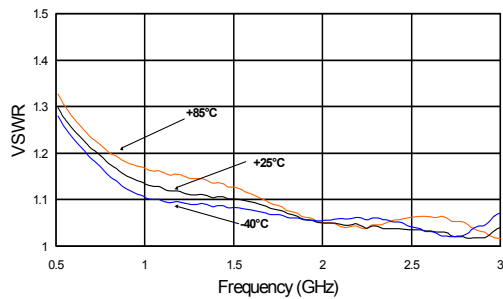

**VSWR, 1000 pF**

