

Dual N-Channel 20-V (D-S) MOSFET

| PRODUCT SUMMARY | | |
|-----------------|---------------------------|------------|
| V_{DS} (V) | $R_{DS(on)}$ (Ω) | I_D (mA) |
| 20 | 0.70 at $V_{GS} = 4.5$ V | 600 |
| | 0.85 at $V_{GS} = 2.5$ V | 500 |
| | 1.25 at $V_{GS} = 1.8$ V | 350 |

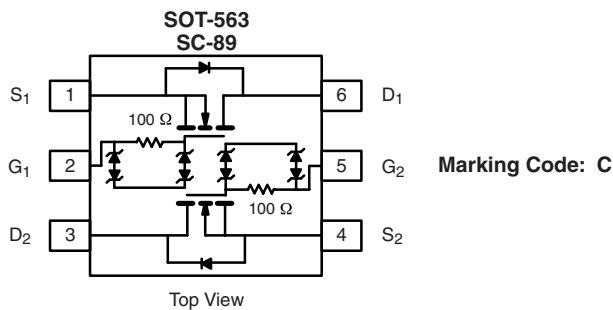

Ordering Information: Si1024X-T1-E3 (Lead (Pb)-free)
Si1024X-T1-GE3 (Lead (Pb)-free and Halogen-free)

FEATURES

- Halogen-free Option Available
- TrenchFET[®] Power MOSFET: 1.8 V Rated
- Very Small Footprint
- High-Side Switching
- Low On-Resistance: 0.7 Ω
- Low Threshold: 0.8 V (typ.)
- Fast Switching Speed: 10 ns
- 1.8 V Operation
- Gate-Source ESD Protected: 2000 V



RoHS
COMPLIANT

BENEFITS

- Ease in Driving Switches
- Low Offset (Error) Voltage
- Low-Voltage Operation
- High-Speed Circuits
- Low Battery Voltage Operation

APPLICATIONS

- Drivers: Relays, Solenoids, Lamps, Hammers, Displays, Memories
- Battery Operated Systems
- Power Supply Converter Circuits
- Load/Power Switching Cell Phones, Pagers

| ABSOLUTE MAXIMUM RATINGS $T_A = 25$ °C, unless otherwise noted | | | | | |
|--|----------------|---------------|--------------|------|----|
| Parameter | Symbol | 5 s | Steady State | Unit | |
| Drain-Source Voltage | V_{DS} | 20 | | V | |
| Gate-Source Voltage | V_{GS} | ± 6 | | | |
| Continuous Drain Current ($T_J = 150$ °C) ^a | I_D | $T_A = 25$ °C | 515 | 485 | mA |
| | | $T_A = 85$ °C | 370 | 350 | |
| Pulsed Drain Current ^b | I_{DM} | 650 | | | |
| Continuous Source Current (Diode Conduction) ^a | I_S | 450 | 380 | | |
| Maximum Power Dissipation ^a | P_D | $T_A = 25$ °C | 280 | 250 | mW |
| | | $T_A = 85$ °C | 145 | 130 | |
| Operating Junction and Storage Temperature Range | T_J, T_{stg} | - 55 to 150 | | °C | |
| Gate-Source ESD Rating (HBM, Method 3015) | ESD | 2000 | | V | |

Notes:

- a. Surface Mounted on FR4 board.
b. Pulse width limited by maximum junction temperature.

| SPECIFICATIONS $T_J = 25^\circ\text{C}$, unless otherwise noted | | | | | | |
|--|--------------|---|------|-----------|-----------|---------------|
| Parameter | Symbol | Test Conditions | Min. | Typ. | Max. | Unit |
| Static | | | | | | |
| Gate Threshold Voltage | $V_{GS(th)}$ | $V_{DS} = V_{GS}$, $I_D = 250\ \mu\text{A}$ | 0.45 | | 0.9 | V |
| Gate-Body Leakage | I_{GSS} | $V_{DS} = 0\ \text{V}$, $V_{GS} = \pm 4.5\ \text{V}$ | | ± 0.5 | ± 1.0 | μA |
| Zero Gate Voltage Drain Current | I_{DSS} | $V_{DS} = 20\ \text{V}$, $V_{GS} = 0\ \text{V}$ | | 0.3 | 100 | nA |
| | | $V_{DS} = 20\ \text{V}$, $V_{GS} = 0\ \text{V}$, $T_J = 85^\circ\text{C}$ | | | 5 | μA |
| On-State Drain Current ^a | $I_{D(on)}$ | $V_{DS} = 5\ \text{V}$, $V_{GS} = 4.5\ \text{V}$ | 700 | | | mA |
| Drain-Source On-State Resistance ^a | $R_{DS(on)}$ | $V_{GS} = 4.5\ \text{V}$, $I_D = 600\ \text{mA}$ | | 0.41 | 0.70 | Ω |
| | | $V_{GS} = 2.5\ \text{V}$, $I_D = 500\ \text{mA}$ | | 0.53 | 0.85 | |
| | | $V_{GS} = 1.8\ \text{V}$, $I_D = 350\ \text{mA}$ | | 0.70 | 1.25 | |
| Forward Transconductance ^a | g_{fs} | $V_{DS} = 10\ \text{V}$, $I_D = 400\ \text{mA}$ | | 1.0 | | S |
| Diode Forward Voltage ^a | V_{SD} | $I_S = 150\ \text{mA}$, $V_{GS} = 0\ \text{V}$ | | 0.8 | 1.2 | V |
| Dynamic^b | | | | | | |
| Total Gate Charge | Q_g | $V_{DS} = 10\ \text{V}$, $V_{GS} = 4.5\ \text{V}$, $I_D = 250\ \text{mA}$ | | 750 | | μC |
| Gate-Source Charge | Q_{gs} | | | 75 | | |
| Gate-Drain Charge | Q_{gd} | | | 225 | | |
| Turn-On Time | $t_{d(on)}$ | $V_{DD} = 10\ \text{V}$, $R_L = 47\ \Omega$ $I_D \cong 200\ \text{mA}$, $V_{GEN} = 4.5\ \text{V}$, $R_G = 10\ \Omega$ | | 10 | | ns |
| Turn-Off Time | $t_{d(off)}$ | | | 36 | | |

Notes:

- a. Pulse test; pulse width $\leq 300\ \mu\text{s}$, duty cycle $\leq 2\%$.
b. Guaranteed by design, not subject to production testing.

Stresses beyond those listed under "Absolute Maximum Ratings" may cause permanent damage to the device. These are stress ratings only, and functional operation of the device at these or any other conditions beyond those indicated in the operational sections of the specifications is not implied. Exposure to absolute maximum rating conditions for extended periods may affect device reliability.

TYPICAL CHARACTERISTICS $T_A = 25^\circ\text{C}$, unless otherwise noted

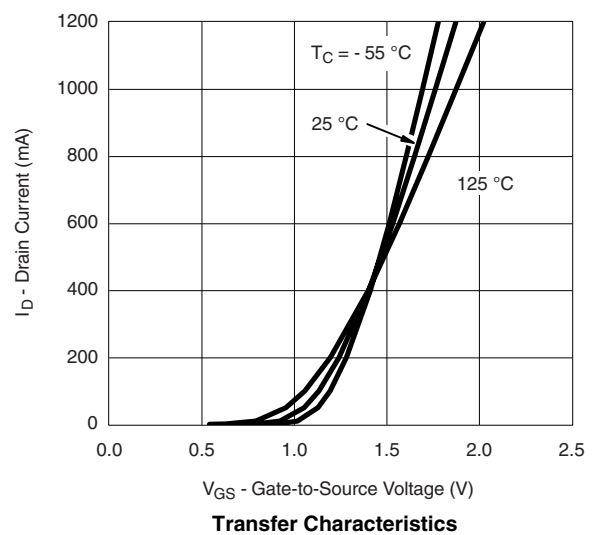
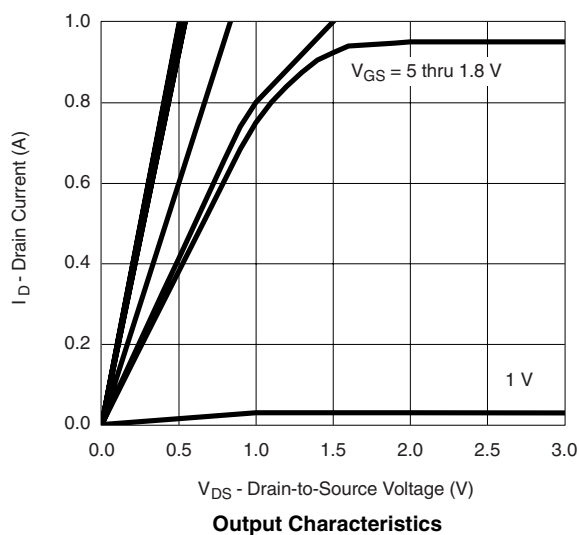

TYPICAL CHARACTERISTICS $T_A = 25\text{ }^\circ\text{C}$, unless otherwise noted

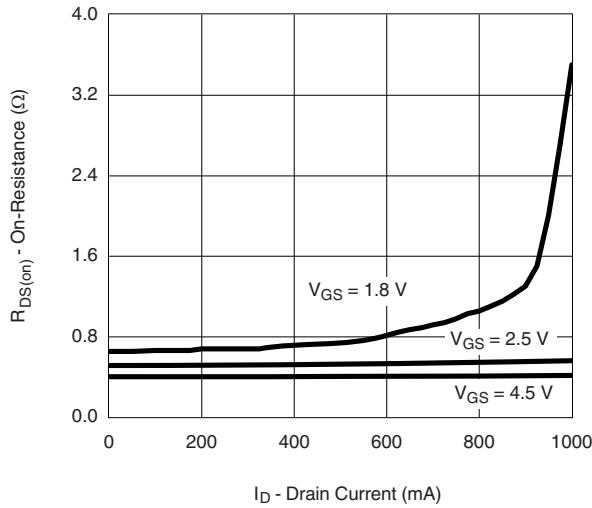

On-Resistance vs. Drain Current

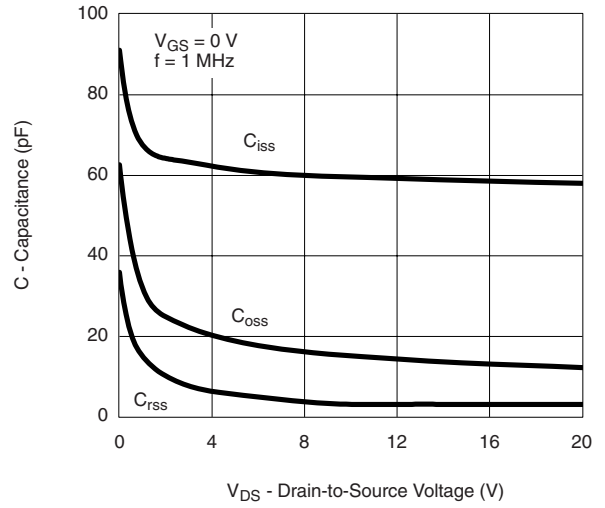

Capacitance

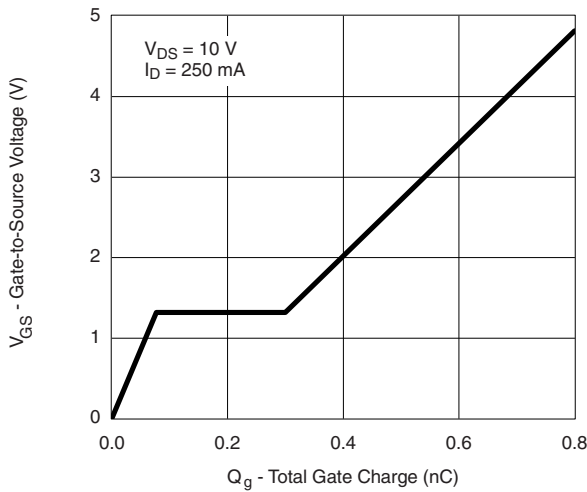

Gate Charge

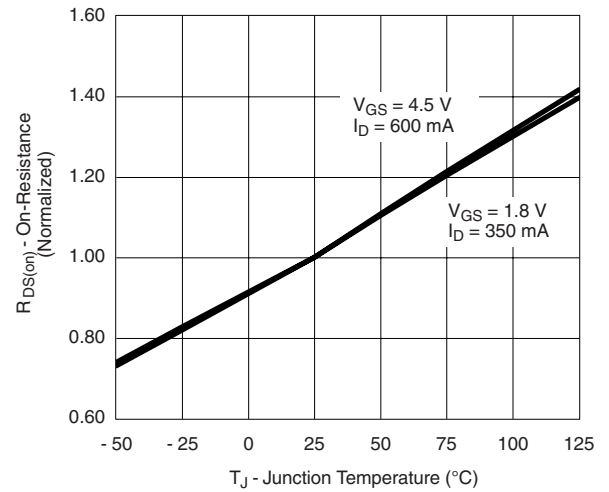

On-Resistance vs. Junction Temperature

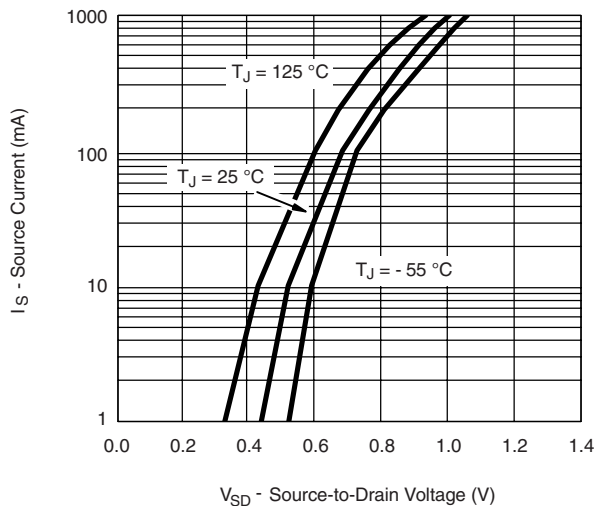

Source-Drain Diode Forward Voltage

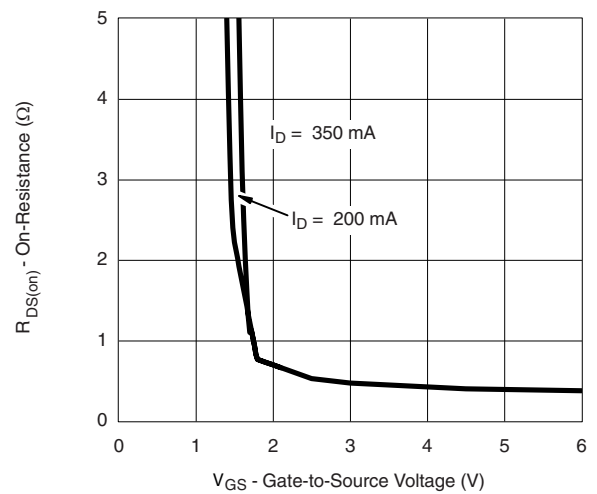

On-Resistance vs. Gate-to-Source Voltage

TYPICAL CHARACTERISTICS $T_A = 25\text{ }^\circ\text{C}$, unless otherwise noted

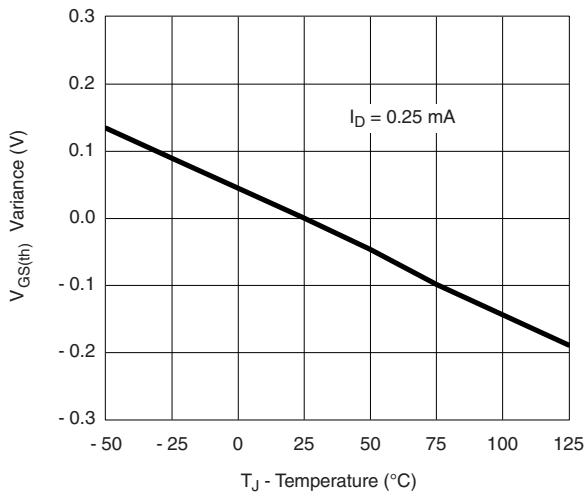

Threshold Voltage Variance vs. Temperature

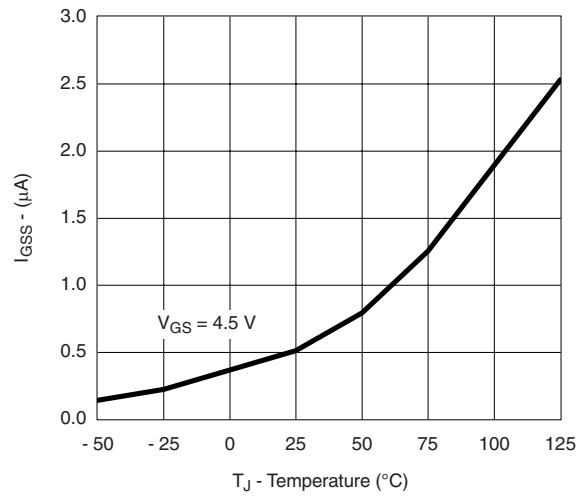

I_{GSS} vs. Temperature

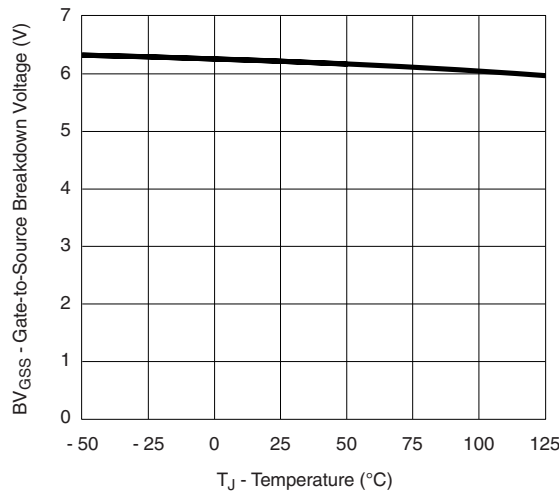

BV_{GSS} vs. Temperature

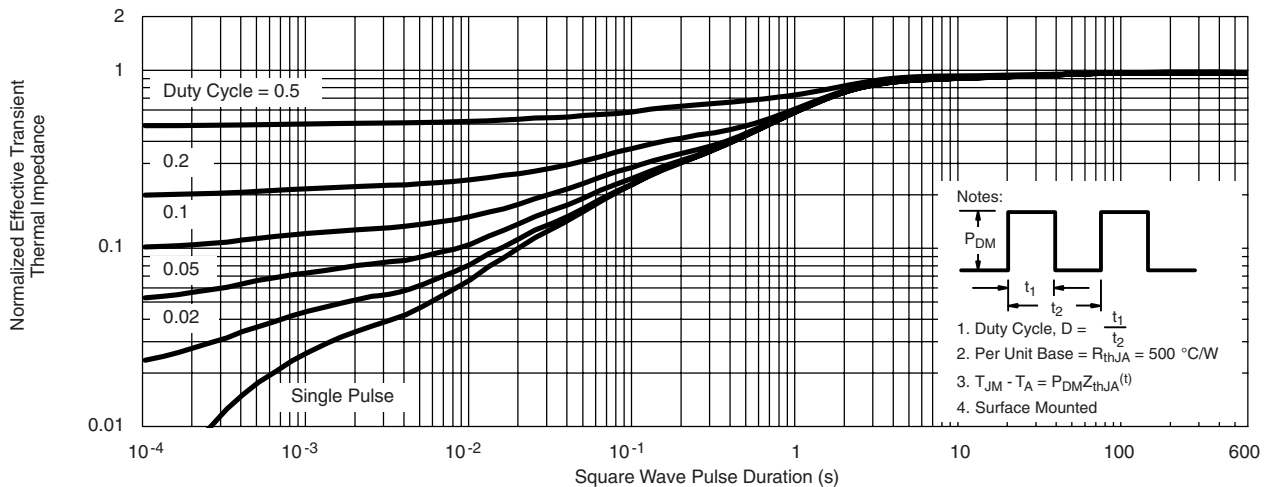

Normalized Thermal Transient Impedance, Junction-to-Ambient

Vishay Siliconix maintains worldwide manufacturing capability. Products may be manufactured at one of several qualified locations. Reliability data for Silicon Technology and Package Reliability represent a composite of all qualified locations. For related documents such as package/tape drawings, part marking, and reliability data, see <http://www.vishay.com/ppg?71170>.



Notice

Specifications of the products displayed herein are subject to change without notice. Vishay Intertechnology, Inc., or anyone on its behalf, assumes no responsibility or liability for any errors or inaccuracies.

Information contained herein is intended to provide a product description only. No license, express or implied, by estoppel or otherwise, to any intellectual property rights is granted by this document. Except as provided in Vishay's terms and conditions of sale for such products, Vishay assumes no liability whatsoever, and disclaims any express or implied warranty, relating to sale and/or use of Vishay products including liability or warranties relating to fitness for a particular purpose, merchantability, or infringement of any patent, copyright, or other intellectual property right.

The products shown herein are not designed for use in medical, life-saving, or life-sustaining applications. Customers using or selling these products for use in such applications do so at their own risk and agree to fully indemnify Vishay for any damages resulting from such improper use or sale.