



ELECTROSTATIC SENSITIVE DEVICE
OBSERVE HANDLING PRECAUTIONS

MITSUBISHI RF POWER MOS FET

RD60HUF1

Silicon MOSFET Power Transistor 520MHz,60W

DESCRIPTION

RD60HUF1 is a MOS FET type transistor specifically designed for UHF High power amplifiers applications.

FEATURES

- High power and High Gain:
Pout>60W, Gp>7.7dB @Vdd=12.5V,f=520MHz
- High Efficiency: 55%typ.on UHF Band

APPLICATION

For output stage of high power amplifiers in UHF Band mobile radio sets.

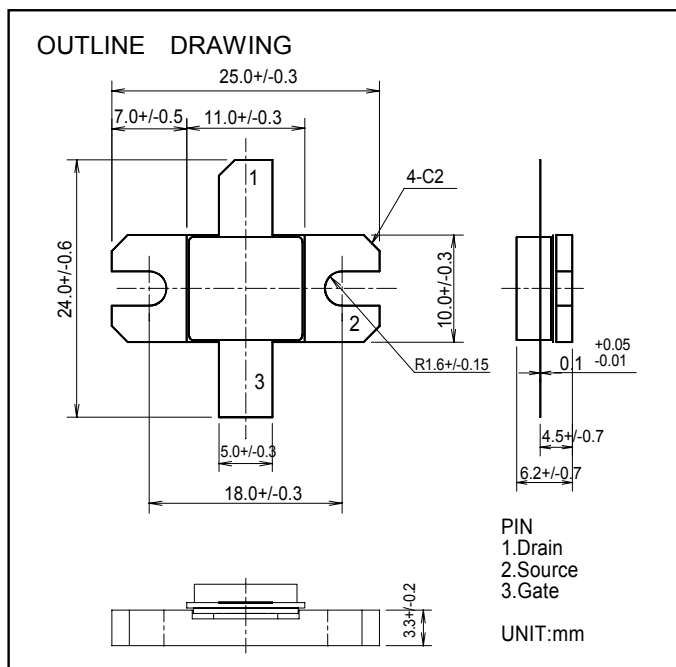

ABSOLUTE MAXIMUM RATINGS

(Tc=25°C UNLESS OTHERWISE NOTED)

SYMBOL	PARAMETER	CONDITIONS	RATINGS	UNIT
VDSS	Drain to source voltage		30	V
VGSS	Gate to source voltage		+/-20	V
Pch	Channel dissipation	Tc=25°C	150	W
Tj	Junction Temperature		175	°C
Tstg	Storage temperature		-40 to +175	°C
Rth-c	Thermal resistance	Junction to case	1.0	°C/W

Note 1: Above parameters are guaranteed independently.

ELECTRICAL CHARACTERISTICS (Tc=25°C, UNLESS OTHERWISE NOTED)

SYMBOL	PARAMETER	CONDITIONS	LIMITS			UNIT
			MIN	TYP	MAX.	
Idss	Zero gate voltage drain current	VDS=17V, VGS=0V	-	-	400	µA
IGSS	Gate to source leak current	VGS=10V, VDS=0V	-	-	1	µA
VTH	Gate threshold voltage	VDS=12V, Ids=1mA	1.1	1.45	1.8	V
Pout	Output power	f=520MHz, VDD=12.5V	60	65	-	W
ηD	Drain efficiency	Pin=10W, Idq=2.5A	50	55	-	%
	Load VSWR tolerance	VDD=15.2V, Po=60W (Pin Control) Idq=2.5A, Zg=50Ω Load VSWR=20:1 (All Phase)	No destroy			-

Note : Above parameters, ratings, limits and conditions are subject to change.

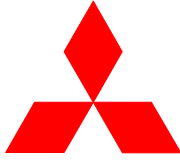

ELECTROSTATIC SENSITIVE DEVICE
OBSERVE HANDLING PRECAUTIONS

MITSUBISHI RF POWER MOS FET

RD60HUF1

Silicon MOSFET Power Transistor 520MHz,60W

TYPICAL CHARACTERISTICS

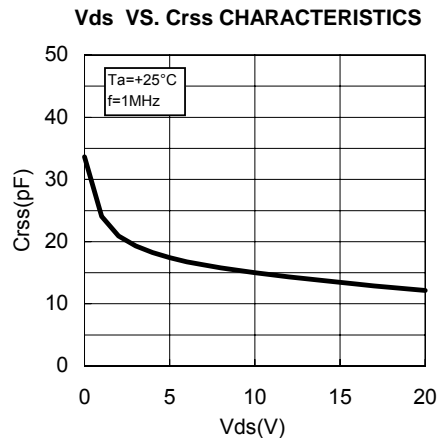
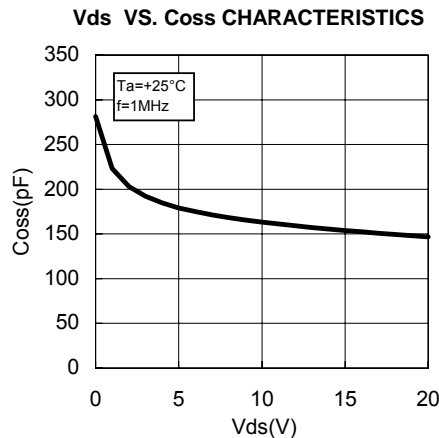
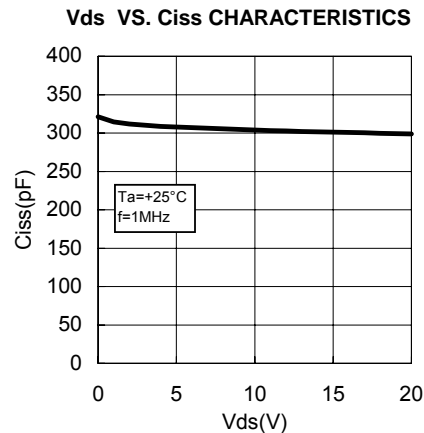
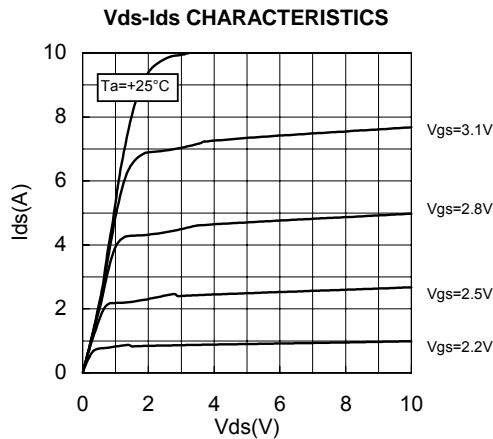
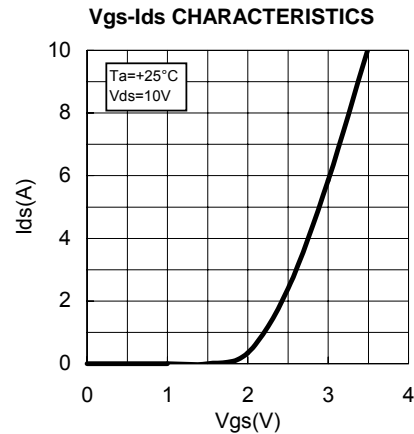
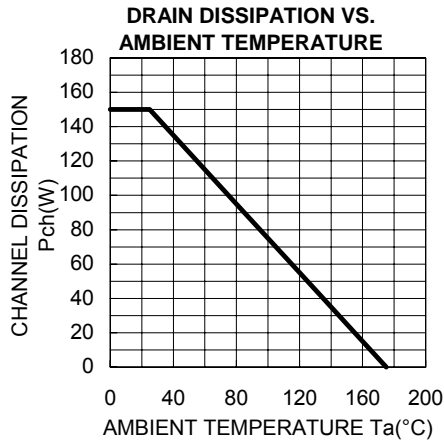

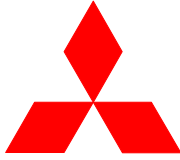

ELECTROSTATIC SENSITIVE DEVICE
OBSERVE HANDLING PRECAUTIONS

MITSUBISHI RF POWER MOS FET

RD60HUF1

Silicon MOSFET Power Transistor 520MHz,60W

TYPICAL CHARACTERISTICS

Pin-Po CHARACTERISTICS

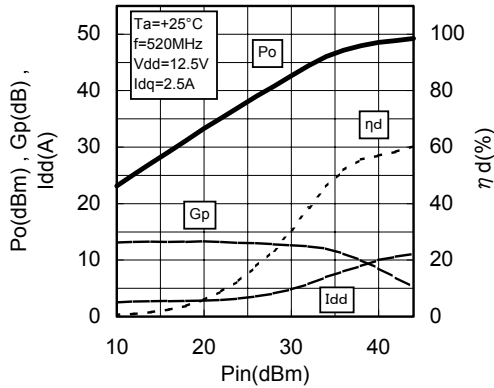

Pin-Po CHARACTERISTICS

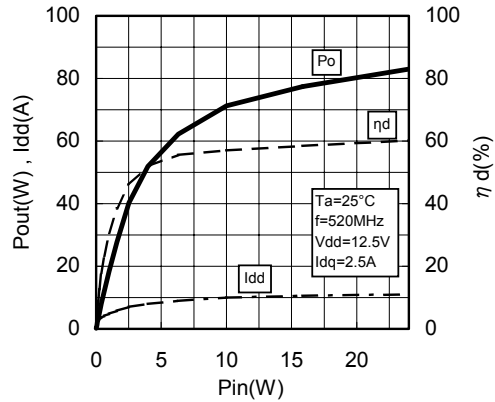

Vdd-Po CHARACTERISTICS

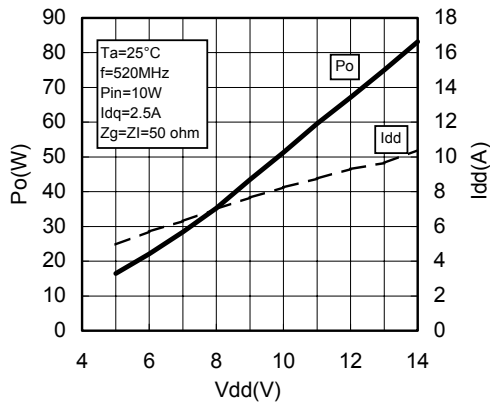

Vgs-Ids CHARACTERISTICS 2

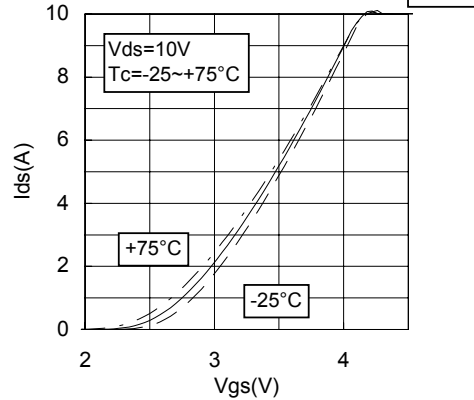



ELECTROSTATIC SENSITIVE DEVICE
OBSERVE HANDLING PRECAUTIONS

MITSUBISHI RF POWER MOS FET

RD60HUF1

Silicon MOSFET Power Transistor 520MHz,60W

TEST CIRCUIT

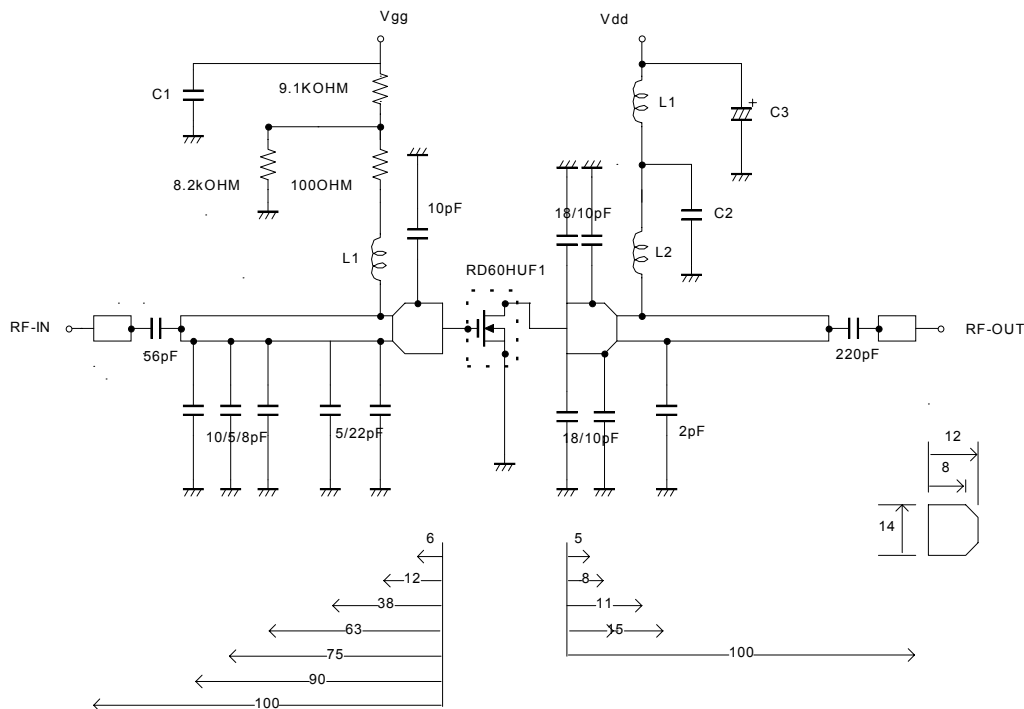

C1:2200pF,10uF in parallel

C2:2200pF*2 in parallel

C3:2200pF,330uF in parallel

L1:4Turns,I.D6mm,D1.6mm P=1 silver plated copper wire

L2:3Turns,I.D6mm,D1.6mm P=1 silver plated copper wire

Note:Board material-Teflon substrate

Micro strip line width=4.2mm/50OHM,er:2.7,t=1.6mm

Dimensions:mm



ELECTROSTATIC SENSITIVE DEVICE
OBSERVE HANDLING PRECAUTIONS

MITSUBISHI RF POWER MOS FET

RD60HUF1

Silicon MOSFET Power Transistor 520MHz,60W

INPUT/OUTPUT IMPEDANCE VS.FREQUENCY CHARACTERISTICS

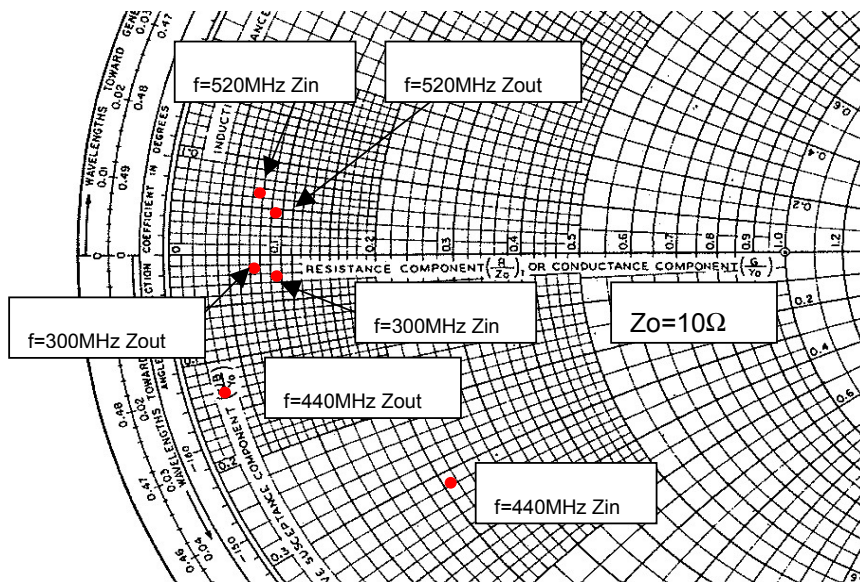

Zin , Zout

f (MHz)	Zin (ohm)	Zout (ohm)	Conditions
300	0.96-j0.22	0.75-j0.12	
440	2.00-j3.10	0.30-j1.40	Po=65W, Vdd=12.5V, Pin=10W
520	0.77+j0.66	0.96+j0.49	Po=60W, Vdd=12.5V, Pin=10W

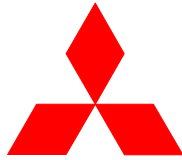

ELECTROSTATIC SENSITIVE DEVICE
OBSERVE HANDLING PRECAUTIONS

MITSUBISHI RF POWER MOS FET

RD60HUF1

Silicon MOSFET Power Transistor 520MHz,60W

RD60HUF1 S-PARAMETER DATA (@V_{dd}=12.5V, I_d=500mA)

Freq. [MHz]	S11		S21		S12		S22	
	(mag)	(ang)	(mag)	(ang)	(mag)	(ang)	(mag)	(ang)
10	0.909	-156.8	0.012	8.6	30.933	98.0	0.788	-166.6
50	0.910	-177.1	0.011	-10.8	6.014	75.6	0.811	-177.2
100	0.923	178.6	0.010	-25.0	2.796	60.1	0.845	-178.5
150	0.935	175.5	0.008	-32.2	1.678	46.1	0.869	178.3
175	0.944	173.9	0.008	-39.0	1.351	40.5	0.877	177.0
200	0.949	172.5	0.007	-41.7	1.109	36.2	0.893	175.6
250	0.957	169.2	0.005	-42.3	0.804	27.2	0.930	172.3
300	0.961	166.2	0.004	-40.2	0.583	18.3	0.930	169.2
350	0.964	163.3	0.003	-21.8	0.450	12.0	0.945	166.0
400	0.969	159.8	0.002	-4.8	0.368	6.8	0.957	162.4
450	0.974	157.0	0.002	38.1	0.296	2.3	0.956	159.5
500	0.975	153.8	0.003	38.4	0.238	-3.0	0.962	156.5
550	0.977	151.0	0.003	49.4	0.209	-6.1	0.965	153.4
600	0.978	147.8	0.005	53.8	0.178	-14.1	0.963	150.1
650	0.982	145.1	0.006	54.4	0.155	-17.5	0.971	147.4
700	0.983	141.9	0.006	50.3	0.136	-19.6	0.973	144.5
750	0.979	139.5	0.007	51.8	0.113	-17.5	0.972	141.5
800	0.982	136.7	0.009	56.2	0.104	-20.2	0.980	138.4
850	0.985	133.7	0.009	49.6	0.103	-33.7	0.978	136.2
900	0.980	130.9	0.010	46.5	0.084	-27.4	0.975	133.1
950	0.981	128.0	0.010	47.2	0.083	-35.1	0.983	130.4
1000	0.981	124.9	0.012	43.8	0.071	-28.7	0.984	128.0

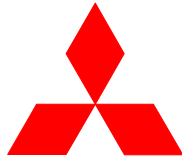

ELECTROSTATIC SENSITIVE DEVICE
OBSERVE HANDLING PRECAUTIONS

MITSUBISHI RF POWER MOS FET

RD60HUF1

Silicon MOSFET Power Transistor 520MHz,60W

Keep safety first in your circuit designs!

Mitsubishi Electric Corporation puts the maximum effort into making semiconductor products better and more reliable, but there is always the possibility that trouble may occur with them. Trouble with semiconductors may lead to personal injury, fire or property damage. Remember to give due consideration to safety when making your circuit designs, with appropriate measures such as (i) placement of substitutive, auxiliary circuits, (ii) use of non-flammable material or (iii) prevention against any malfunction or mishap.