

**ELECTROSTATIC SENSITIVE DEVICE**  
OBSERVE HANDLING PRECAUTIONS

**MITSUBISHI RF POWER MOS FET**

# RD01MUS1

**RoHS Compliance, Silicon MOSFET Power Transistor 520MHz,1W**

## DESCRIPTION

RD01MUS1 is a MOS FET type transistor specifically designed for VHF/UHF RF amplifiers applications.

## FEATURES

High power gain:  
Pout>0.8W, Gp>14dB @Vdd=7.2V,f=520MHz  
High Efficiency: 65%typ.

## APPLICATION

For output stage of high power amplifiers in VHF/UHF Band mobile radio sets.

## RoHS COMPLIANT

RD01MUS1-101,T113 is a RoHS compliant products.  
This product include the lead in high melting temperature type solders.  
How ever,it applicable to the following exceptions of RoHS Directions.  
1.Lead in high melting temperature type solders(i.e.tin-lead solder alloys containing more than85% lead.)

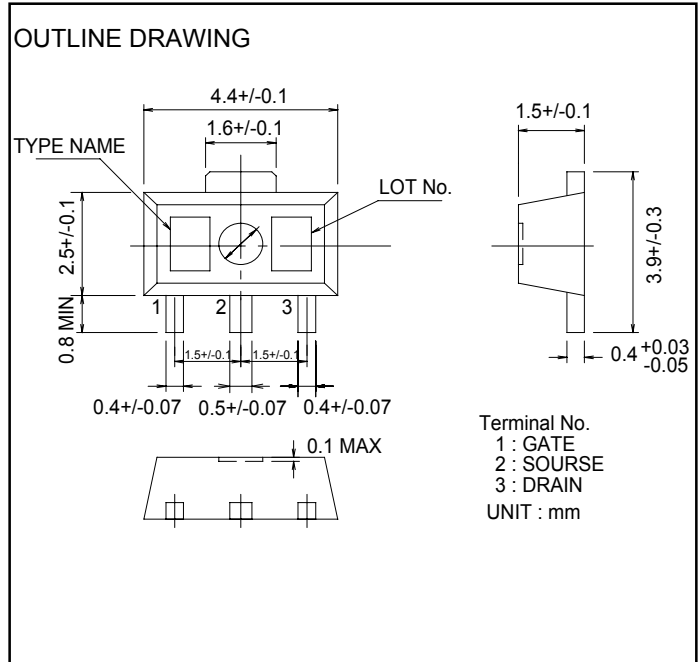

## ABSOLUTE MAXIMUM RATINGS

(Tc=25°C UNLESS OTHERWISE NOTED)

SYMBOL	PARAMETER	CONDITIONS	RATINGS	UNIT
VDSS	Drain to source voltage	Vgs=0V	30	V
VGSS	Gate to source voltage	Vds=0V	+/-10	V
Pch	Channel dissipation	Tc=25°C	3.6	W
Pin	Input Power	Zg=Zl=50Ω	60	mW
ID	Drain Current	-	600	mA
Tch	Channel Temperature	-	150	°C
Tstg	Storage temperature	-	-40 to +125	°C
Rth j-c	Thermal resistance	Junction to case	34.5	°C/W

Note 1: Above parameters are guaranteed independently.

## ELECTRICAL CHARACTERISTICS

(Tc=25°C, UNLESS OTHERWISE NOTED)

SYMBOL	PARAMETER	CONDITIONS	LIMITS			UNIT
			MIN	TYP	MAX	
IDSS	Zero gate voltage drain current	VDS=17V, VGS=0V	-	-	50	uA
IGSS	Gate to source leak current	VGS=10V, VDS=0V	-	-	1	uA
Vth	Gate threshold Voltage	VDS=12V, IDS=1mA	1	1.8	3	V
Pout	Output power	VDD=7.2V, Pin=30mW	0.8	1.4	-	W
ηD	Drain efficiency	f=520MHz, Idq=100mA	50	65	-	%

Note : Above parameters , ratings , limits and conditions are subject to change.

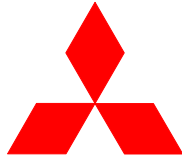

**ELECTROSTATIC SENSITIVE DEVICE**  
OBSERVE HANDLING PRECAUTIONS

MITSUBISHI RF POWER MOS FET

# RD01MUS1

RoHS Compliance, Silicon MOSFET Power Transistor 520MHz,1W

## TYPICAL CHARACTERISTICS

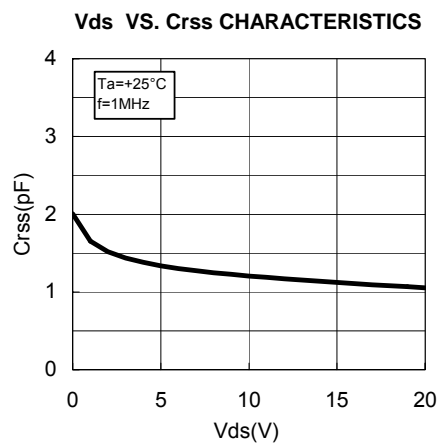
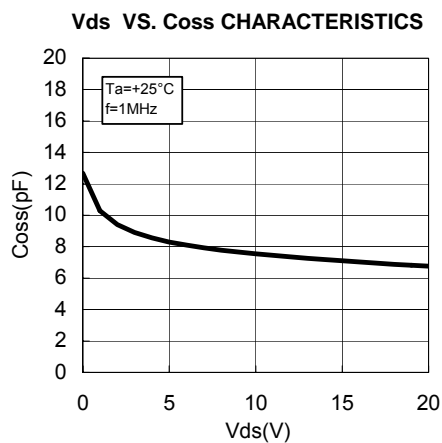
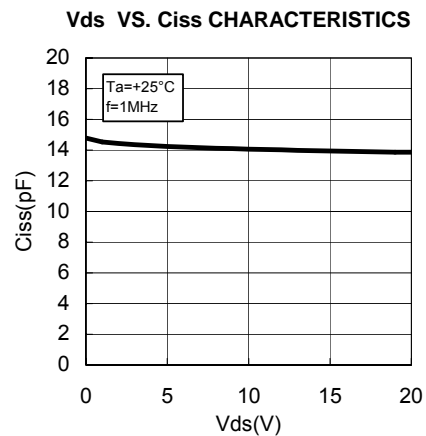
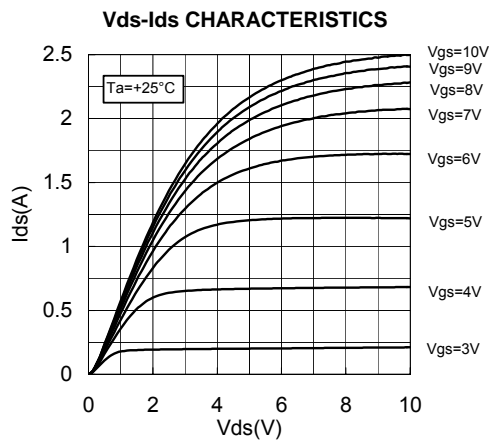
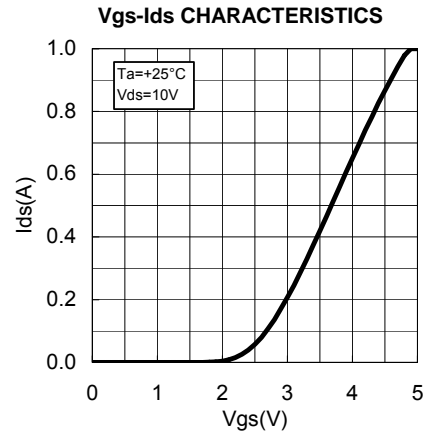
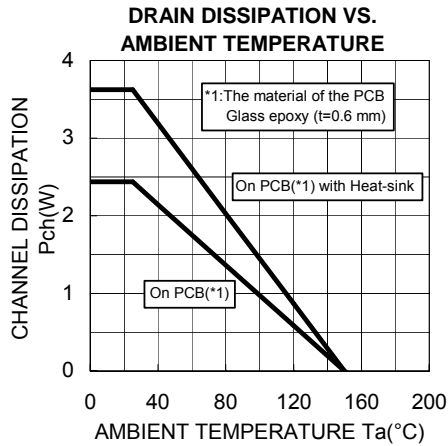

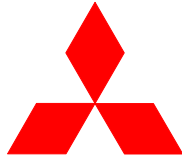

ELECTROSTATIC SENSITIVE DEVICE  
OBSERVE HANDLING PRECAUTIONS

MITSUBISHI RF POWER MOS FET

# RD01MUS1

RoHS Compliance, Silicon MOSFET Power Transistor 520MHz,1W

## TYPICAL CHARACTERISTICS

Pin-Po CHARACTERISTICS

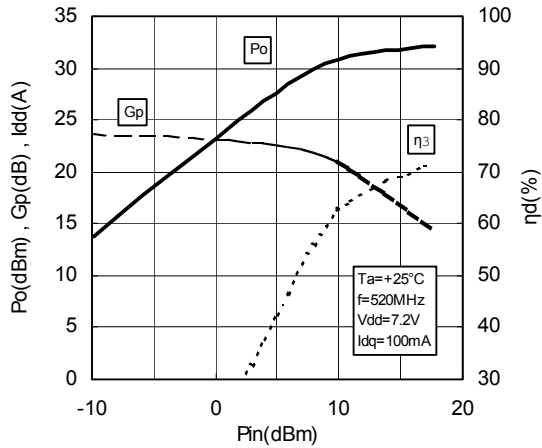

Pin-Po CHARACTERISTICS

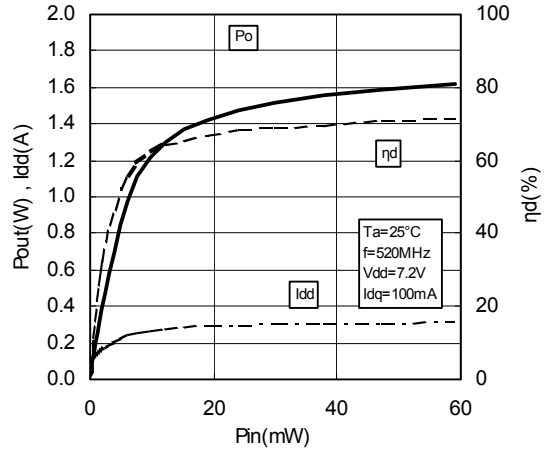

Vdd-Po CHARACTERISTICS

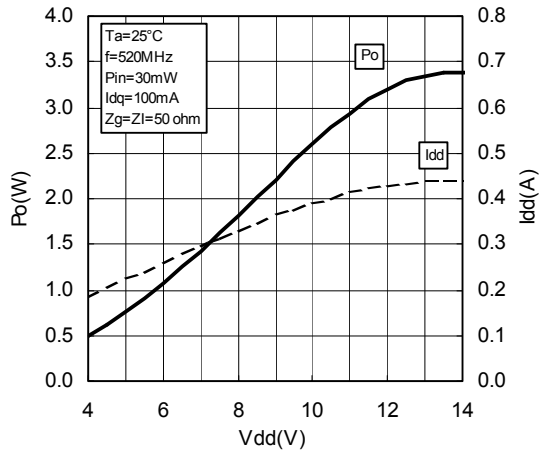

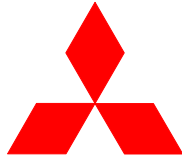

**ELECTROSTATIC SENSITIVE DEVICE**  
OBSERVE HANDLING PRECAUTIONS

MITSUBISHI RF POWER MOS FET

**RD01MUS1**

RoHS Compliance, Silicon MOSFET Power Transistor 520MHz,1W

**TEST CIRCUIT(f=520MHz)**

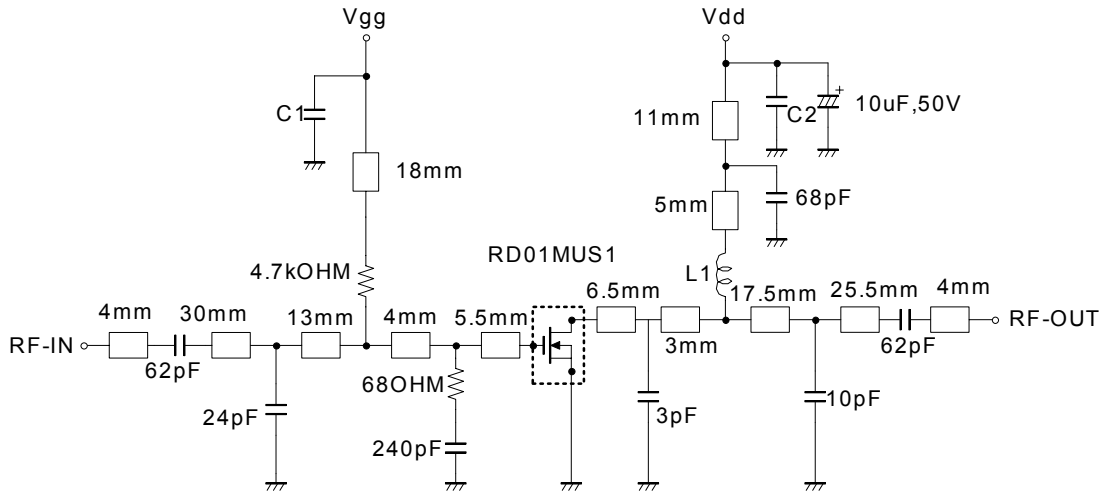

L1: Enameled wire 5Turns, D:0.43mm, 2.46mm O.D  
C1, C2: 1000pF, 0.022uF in parallel

Note: Board material-glass epoxy substrate  
Micro strip line width=1.0mm/50OHM, er:4.8, t=0.6mm

**INPUT/OUTPUT IMPEDANCE VS. FREQUENCY CHARACTERISTICS**

520MHz  $Z_{in}^*$   $Z_{out}^*$   
 $Z_o=50\Omega$

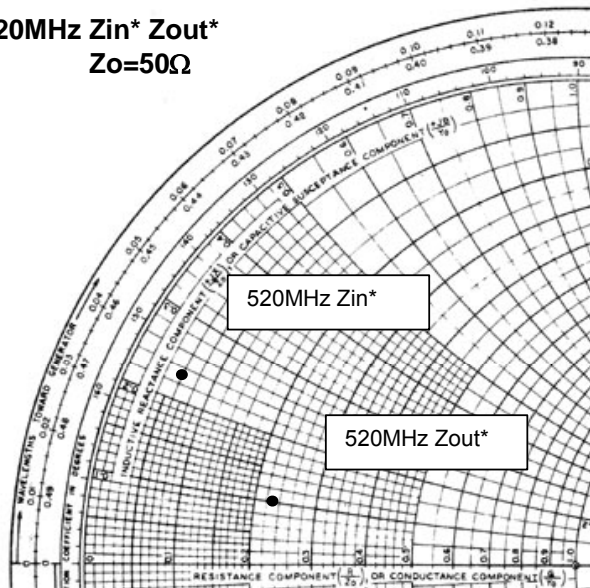

Vdd=7.2V, Idq=100mA(Vgg adj.), Pin=0.03W

$Z_{in}^* = 3.11 + j11.56$   
 $Z_{out}^* = 11.64 + j4.74$

$Z_{in}^*$ : Complex conjugate of input impedance  
 $Z_{out}^*$ : Complex conjugate of input impedance



**ELECTROSTATIC SENSITIVE DEVICE**  
OBSERVE HANDLING PRECAUTIONS

MITSUBISHI RF POWER MOS FET

# RD01MUS1

**RoHS Compliance, Silicon MOSFET Power Transistor 520MHz,1W**

## RD01MSU1 S-PARAMETER DATA (@Vdd=7.2V, Id=100mA)

Freq. [MHz]	S11		S21		S12		S22	
	(mag)	(ang)	(mag)	(ang)	(mag)	(ang)	(mag)	(ang)
100	0.927	-77.0	19.536	132.3	0.043	41.3	0.772	-63.0
150	0.875	-101.2	15.657	116.5	0.050	26.5	0.687	-83.1
200	0.833	-117.9	12.662	105.0	0.053	16.1	0.630	-97.3
250	0.811	-129.5	10.427	96.2	0.054	8.4	0.600	-107.1
300	0.798	-138.0	8.814	89.3	0.053	2.6	0.588	-114.4
350	0.791	-144.5	7.548	83.3	0.052	-2.4	0.583	-120.1
400	0.790	-149.7	6.541	78.2	0.051	-6.6	0.590	-124.6
450	0.788	-154.1	5.789	73.5	0.049	-9.9	0.597	-128.4
500	0.794	-158.0	5.106	69.0	0.047	-13.3	0.608	-131.7
520	0.796	-159.2	4.876	67.5	0.046	-14.1	0.615	-133.1
550	0.798	-161.2	4.576	65.2	0.045	-15.8	0.622	-134.8
600	0.801	-164.2	4.120	61.3	0.043	-18.5	0.636	-137.3
650	0.807	-167.0	3.714	58.0	0.041	-21.0	0.650	-140.1
700	0.813	-169.3	3.389	54.7	0.039	-22.3	0.666	-142.4
750	0.817	-171.6	3.092	51.3	0.036	-24.9	0.680	-144.6
800	0.825	-174.0	2.820	48.6	0.033	-25.7	0.694	-146.8
850	0.831	-176.0	2.616	46.0	0.031	-26.8	0.711	-148.8
900	0.837	-178.0	2.401	42.8	0.028	-27.8	0.723	-150.9
950	0.845	-179.9	2.207	40.9	0.026	-27.3	0.734	-152.9
1000	0.851	178.2	2.076	38.4	0.023	-27.0	0.749	-154.5
1050	0.857	176.5	1.912	35.5	0.021	-26.3	0.760	-156.3
1100	0.862	174.7	1.773	34.0	0.018	-23.8	0.771	-158.2

## RD01MSU1 S-PARAMETER DATA (@Vdd=12.5V, Id=100mA)

Freq. [MHz]	S11		S21		S12		S22	
	(mag)	(ang)	(mag)	(ang)	(mag)	(ang)	(mag)	(ang)
100	0.945	-72.3	19.517	135.2	0.039	44.5	0.742	-57.4
150	0.896	-96.7	15.937	119.5	0.046	29.2	0.665	-76.6
200	0.856	-113.9	13.050	107.7	0.049	18.5	0.612	-90.6
250	0.833	-126.2	10.830	98.6	0.050	11.2	0.581	-100.4
300	0.819	-135.1	9.194	91.6	0.050	5.0	0.568	-107.8
350	0.810	-141.9	7.890	85.3	0.049	-0.3	0.565	-113.8
400	0.806	-147.7	6.868	80.1	0.047	-4.2	0.571	-118.5
450	0.804	-152.2	6.084	75.3	0.046	-7.7	0.580	-122.3
500	0.808	-156.4	5.382	70.7	0.044	-11.0	0.591	-126.1
520	0.809	-157.8	5.139	69.1	0.044	-12.4	0.596	-127.5
550	0.812	-159.9	4.831	66.7	0.042	-13.7	0.605	-129.4
600	0.813	-163.0	4.356	62.7	0.040	-16.2	0.618	-132.2
650	0.819	-166.0	3.931	59.3	0.038	-18.7	0.633	-135.1
700	0.824	-168.6	3.597	56.0	0.036	-20.8	0.649	-137.6
750	0.827	-171.0	3.283	52.4	0.034	-22.3	0.664	-140.1
800	0.834	-173.3	2.991	49.8	0.031	-23.7	0.678	-142.5
850	0.841	-175.5	2.779	47.1	0.029	-24.6	0.695	-144.5
900	0.845	-177.4	2.554	43.8	0.026	-25.9	0.708	-146.7
950	0.852	-179.4	2.350	41.9	0.024	-25.4	0.720	-148.9
1000	0.857	178.6	2.209	39.4	0.022	-24.3	0.736	-150.7
1050	0.864	176.9	2.035	36.3	0.019	-23.5	0.747	-152.4
1100	0.868	175.0	1.889	34.8	0.017	-20.1	0.759	-154.6

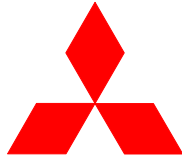

**ELECTROSTATIC SENSITIVE DEVICE**  
OBSERVE HANDLING PRECAUTIONS

**mitsubishi** RF POWER MOS FET

**RD01MUS1**

**RoHS Compliance, Silicon MOSFET Power Transistor 520MHz,1W**

---

Keep safety first in your circuit designs!

Mitsubishi Electric Corporation puts the maximum effort into making semiconductor products better and more reliable, but there is always the possibility that trouble may occur with them. Trouble with semiconductors may lead to personal injury, fire or property damage. Remember to give due consideration to safety when making your circuit designs, with appropriate measures such as (i) placement of substitutive, auxiliary circuits, (ii) use of non-flammable material or (iii) prevention against any malfunction or mishap.

**warning !**

Do not use the device at the exceeded the maximum rating condition. In case of plastic molded devices, the exceeded maximum rating condition may cause blowout, smoldering or catch fire of the molding resin due to extreme short current flow between the drain and the source of the device. These results causes in fire or injury.