

# QM300HC-M

HIGH POWER SWITCHING USE  
NON-INSULATED TYPE

QM300HC-M



- **I<sub>C</sub>** Collector current ..... **300A**
- **V<sub>CEX</sub>** Collector-emitter voltage ..... **350V**
- **h<sub>FE</sub>** DC current gain ..... **100**
- **Non-Insulated Type**

## APPLICATION

Robotics, Welders, Forklifts, Golf cart

## OUTLINE DRAWING & CIRCUIT DIAGRAM

Dimensions in mm

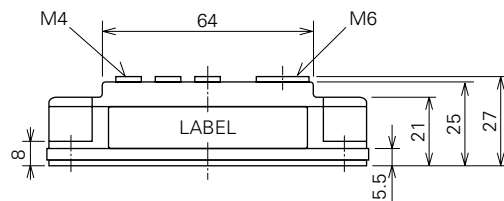
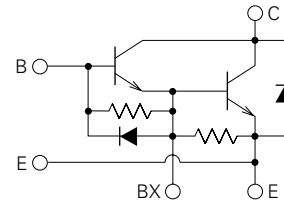
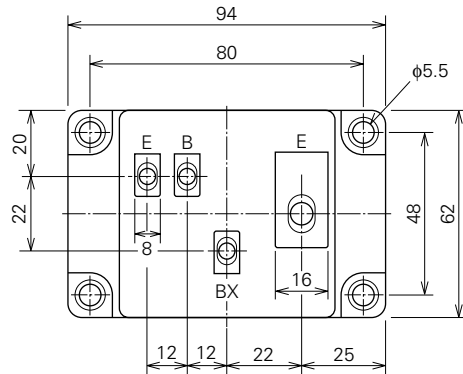

# QM300HC-M

HIGH POWER SWITCHING USE  
NON-INSULATED TYPE

## ABSOLUTE MAXIMUM RATINGS (T<sub>j</sub>=25°C, unless otherwise noted)

Symbol	Parameter	Conditions	Ratings	Unit
V <sub>CEX (SUS)</sub>	Collector-emitter voltage	I <sub>c</sub> =1A, V <sub>EB</sub> =2V	350	V
V <sub>CEX</sub>	Collector-emitter voltage	V <sub>EB</sub> =2V	350	V
V <sub>CBO</sub>	Collector-base voltage	Emitter open	400	V
V <sub>EBO</sub>	Emitter-base voltage	Collector open	10	V
I <sub>c</sub>	Collector current	DC	300	A
-I <sub>c</sub>	Collector reverse current	DC (forward diode current)	300	A
P <sub>c</sub>	Collector dissipation	T <sub>c</sub> =25°C	1250	W
I <sub>B</sub>	Base current	DC	10	A
-I <sub>CSM</sub>	Surge collector reverse current (forward diode current)	Peak value of one cycle of 60Hz (half wave)	3000	A
T <sub>j</sub>	Junction temperature		-40~+150	°C
T <sub>stg</sub>	Storage temperature		-40~+125	°C
V <sub>iso</sub>	Isolation voltage	Charged part to case, AC for 1 minute	—	V
—	Mounting torque	B(E) terminal screw M4	0.98~1.47	N·m
			10~15	kg·cm
		BX terminal screw M4	0.98~1.47	N·m
			10~15	kg·cm
		Main terminal screw M6	1.96~2.94	N·m
			20~30	kg·cm
Mounting screw M5	1.47~1.96	N·m		
	15~20	kg·cm		
—	Weight	Typical value	420	g

## ELECTRICAL CHARACTERISTICS (T<sub>j</sub>=25°C, unless otherwise noted)

Symbol	Parameter	Test conditions	Limits			Unit
			Min.	Typ.	Max.	
I <sub>CEX</sub>	Collector cutoff current	V <sub>CE</sub> =350V, V <sub>EB</sub> =2V	—	—	2.0	mA
I <sub>CBO</sub>	Collector cutoff current	V <sub>CB</sub> =400V, Emitter open	—	—	2.0	mA
I <sub>EBO</sub>	Emitter cutoff current	V <sub>EB</sub> =10V	—	—	600	mA
V <sub>CE (sat)</sub>	Collector-emitter saturation voltage	I <sub>c</sub> =300A, I <sub>B</sub> =3.0A	—	—	2.0	V
V <sub>BE (sat)</sub>	Base-emitter saturation voltage		—	—	2.5	V
-V <sub>CEO</sub>	Collector-emitter reverse voltage	-I <sub>c</sub> =300A (diode forward voltage)	—	—	1.85	V
h <sub>FE</sub>	DC current gain	I <sub>c</sub> =300A, V <sub>CE</sub> =2V	100	—	—	—
t <sub>on</sub>	Switching time	V <sub>CC</sub> =200V, I <sub>c</sub> =300A, I <sub>B1</sub> =-I <sub>B2</sub> =6A	—	—	2.0	μs
t <sub>s</sub>			—	—	10	μs
t <sub>f</sub>			—	—	3.0	μs
R <sub>th (j-c) Q</sub>	Thermal resistance (junction to case)	Transistor part	—	—	0.1	°C/W
R <sub>th (j-c) R</sub>		Diode part	—	—	0.25	°C/W
R <sub>th (c-f)</sub>	Contact thermal resistance (case to fin)	Conductive grease applied	—	—	0.05	°C/W

# QM300HC-M

HIGH POWER SWITCHING USE  
NON-INSULATED TYPE

## PERFORMANCE CURVES

COMMON EMITTER OUTPUT CHARACTERISTICS (TYPICAL)

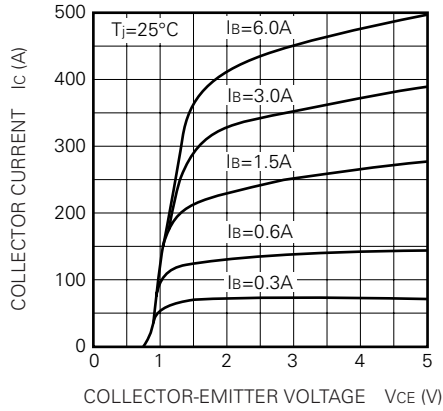

DC CURRENT GAIN VS. COLLECTOR CURRENT (TYPICAL)

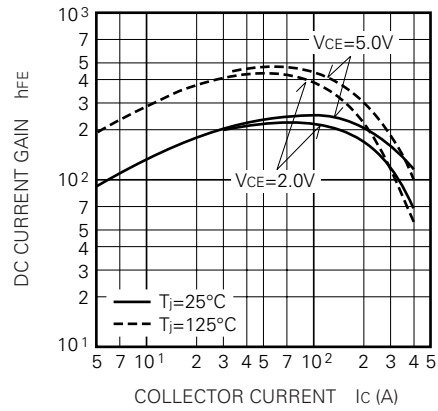

COMMON EMITTER INPUT CHARACTERISTIC (TYPICAL)

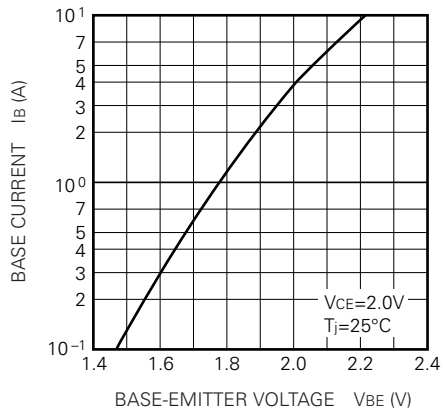

SATURATION VOLTAGE CHARACTERISTICS (TYPICAL)

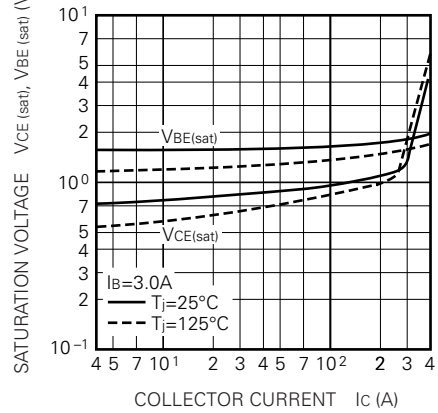

COLLECTOR-EMITTER SATURATION VOLTAGE (TYPICAL)

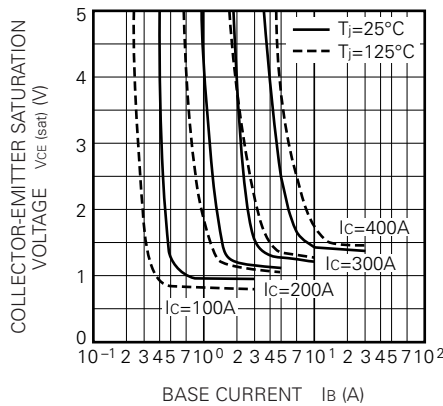

SWITCHING TIME VS. COLLECTOR CURRENT (TYPICAL)

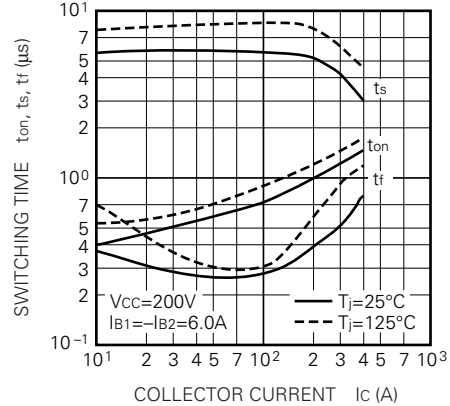

**QM300HC-M**

**HIGH POWER SWITCHING USE  
NON-INSULATED TYPE**

**SWITCHING TIME VS. BASE CURRENT (TYPICAL)**

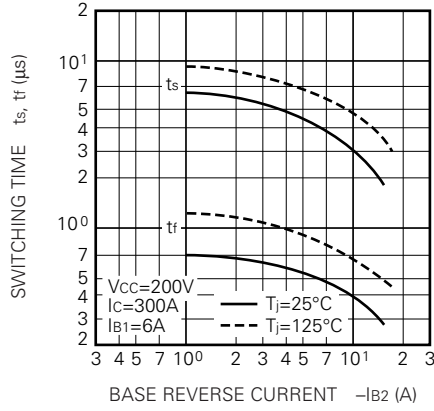

**REVERSE BIAS SAFE OPERATING AREA**

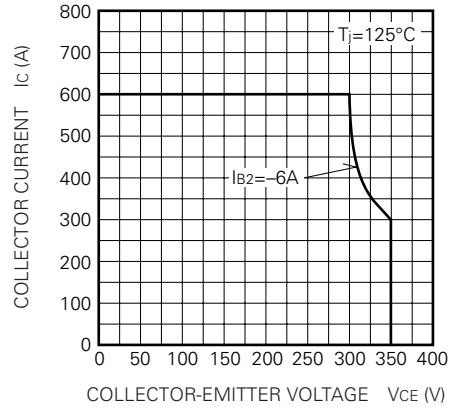

**FORWARD BIAS SAFE OPERATING AREA**

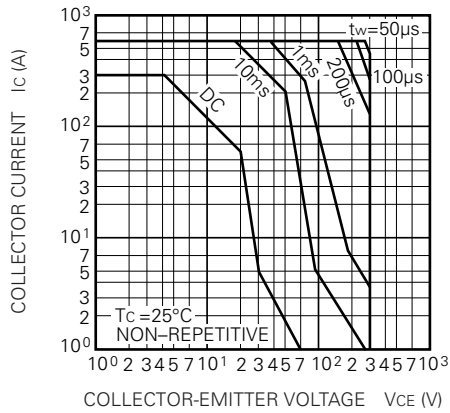

**DERATING FACTOR OF F. B. S. O. A.**

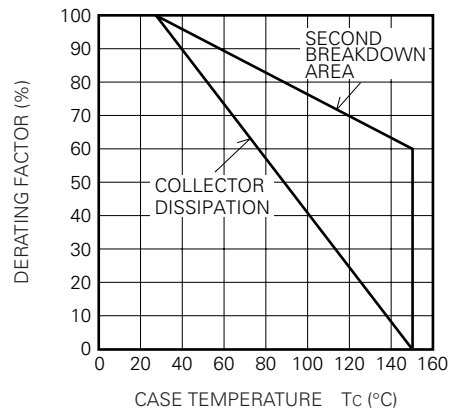

**TRANSIENT THERMAL IMPEDANCE CHARACTERISTIC (TRANSISTOR)**

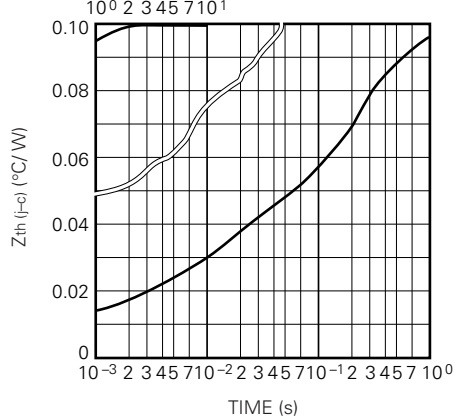

**REVERSE COLLECTOR CURRENT VS. COLLECTOR-EMITTER REVERSE VOLTAGE (DIODE FORWARD CHARACTERISTICS) (TYPICAL)**

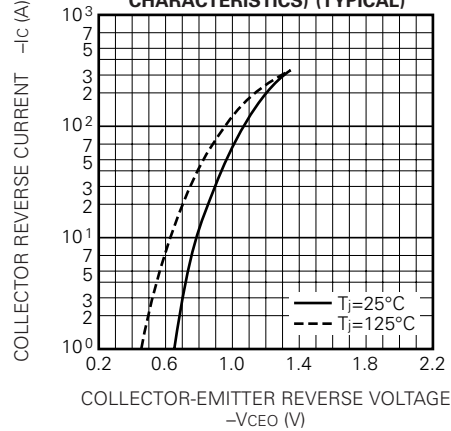

# QM300HC-M

HIGH POWER SWITCHING USE  
NON-INSULATED TYPE

**RATED SURGE COLLECTOR REVERSE CURRENT  
(DIODE FORWARD SURGE CURRENT)**

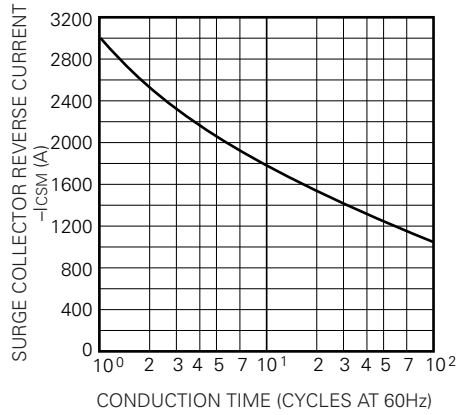

**REVERSE RECOVERY CHARACTERISTICS  
OF FREE-WHEEL DIODE (TYPICAL)**

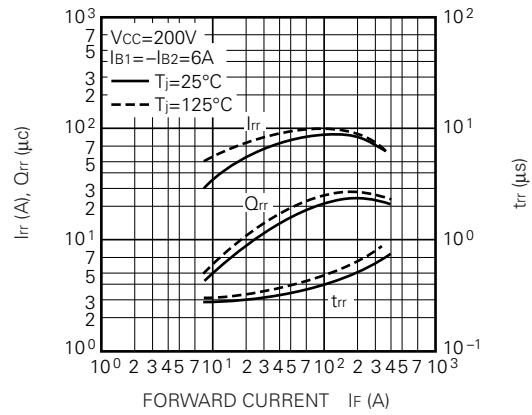

**TRANSIENT THERMAL IMPEDANCE  
CHARACTERISTIC (DIODE)**

