

# SMD Inductors(Coils) For High Frequency(Multilayer)

Conformity to RoHS Directive

## MLG Series MLG1005S Type

### FEATURES

- Nominal inductance values are supported from 0.3 to 390nH.
- Provides high Q characteristics.
- Advanced monolithic structure is formed using a multilayering and sintering process with ceramic and conductive materials for high-frequency.
- The products contain no lead and also support lead-free soldering.
- It is a product conforming to RoHS directive.

### APPLICATIONS

For high-frequency applications including mobile phones, high frequency modules (PA, VCO, FEM etc.), Bluetooth, W-LAN, UWB and tuners.

### SHAPES AND DIMENSIONS

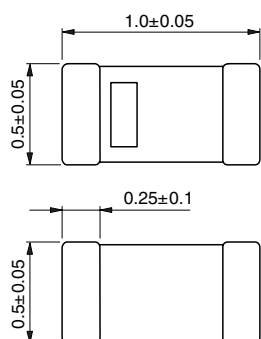

Weight: 1mg

### RECOMMENDED PC BOARD PATTERN

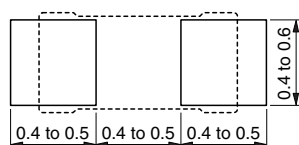

Dimensions in mm



### RECOMMENDED SOLDERING CONDITION REFLOW SOLDERING

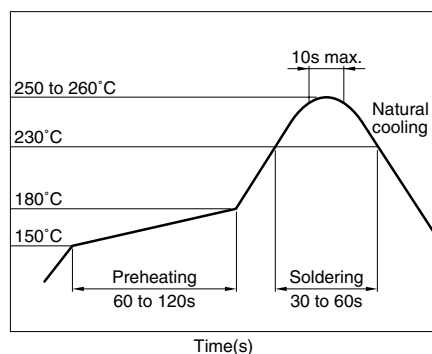

- Conformity to RoHS Directive: This means that, in conformity with EU Directive 2002/95/EC, lead, cadmium, mercury, hexavalent chromium, and specific bromine-based flame retardants, PBB and PBDE, have not been used, except for exempted applications.
- Please contact our Sales office when your application are considered the following:  
The device's failure or malfunction may directly endanger human life (e.g. application for automobile/aircraft/medical/nuclear power devices, etc.)

• All specifications are subject to change without notice.

### PRODUCT IDENTIFICATION

MLG	1005	S	2N2	S	T
(1)	(2)	(3)	(4)	(5)	(6)

(1) Series name

(2) Dimensions

1005	1.0×0.5mm (L×W)
------	-----------------

(3) Material code

(4) Inductance value

2N2	2.2nH
12N	12nH
R10	100nH

(5) Inductance tolerance

B	±0.1nH
C	±0.2nH
S	±0.3nH
H	±3%
J	±5%

(6) Packaging style

T	Taping (reel)
---	---------------

### SPECIFICATIONS

Operating temperature range	-55 to +125°C
Storage temperature range	-55 to +125°C [Unit of products]

### PACKAGING STYLE AND QUANTITIES

Packaging style	Quantity
Taping	10000 pieces/reel

### HANDLING AND PRECAUTIONS

- Before soldering, be sure to preheat components.  
The preheating temperature should be set so that the temperature difference between the solder temperature and product temperature does not exceed 150°C.
- After mounting components onto the printed circuit board, do not apply stress through board bending or mishandling.
- When hand soldering, apply the soldering iron to the printed circuit board only. Temperature of the iron tip should not exceed 350°C. Soldering time should not exceed 3 seconds.

## ELECTRICAL CHARACTERISTICS

Inductance (nH)	Inductance tolerance	Q min.	Test frequency L, Q (MHz)	Self-resonant frequency (GHz)		DC resistance ( $\Omega$ )		Rated current (mA)max.	Part No.
				min.	typ.	max.	typ.		
0.3	$\pm 0.1, \pm 0.2$ nH	—	100	10.0	20up	0.10	0.01	1000	MLG1005S0N3□*T
0.4	$\pm 0.1, \pm 0.2$ nH	—	100	10.0	20up	0.10	0.01	1000	MLG1005S0N4□T
0.5	$\pm 0.1, \pm 0.2$ nH	—	100	10.0	20up	0.10	0.01	1000	MLG1005S0N5□T
0.6	$\pm 0.1, \pm 0.2$ nH	—	100	10.0	20up	0.10	0.01	1000	MLG1005S0N6□T
0.7	$\pm 0.1, \pm 0.2$ nH	—	100	10.0	18.7	0.10	0.02	1000	MLG1005S0N7□T
0.8	$\pm 0.1, \pm 0.2$ nH	—	100	10.0	16.4	0.10	0.02	1000	MLG1005S0N8□T
0.9	$\pm 0.1, \pm 0.2$ nH	—	100	10.0	17.7	0.10	0.04	1000	MLG1005S0N9□T
1.0	$\pm 0.1, \pm 0.2, 0.3$ nH	7	100	10.0	13.8	0.10	0.04	1000	MLG1005S1N0□T
1.1	$\pm 0.1, \pm 0.2, 0.3$ nH	7	100	10.0	19.3	0.10	0.03	1000	MLG1005S1N1□T
1.2	$\pm 0.1, \pm 0.2, 0.3$ nH	7	100	10.0	11.6	0.10	0.04	1000	MLG1005S1N2□T
1.3	$\pm 0.1, \pm 0.2, 0.3$ nH	7	100	8.00	11.7	0.10	0.04	1000	MLG1005S1N3□T
1.5	$\pm 0.1, \pm 0.2, 0.3$ nH	7	100	8.00	9.6	0.10	0.06	1000	MLG1005S1N5□T
1.6	$\pm 0.1, \pm 0.2, 0.3$ nH	7	100	7.50	9.4	0.12	0.05	1000	MLG1005S1N6□T
1.8	$\pm 0.1, \pm 0.2, 0.3$ nH	7	100	7.50	10.3	0.15	0.06	900	MLG1005S1N8□T
2.0	$\pm 0.1, \pm 0.2, 0.3$ nH	7	100	7.50	9.3	0.15	0.07	900	MLG1005S2N0□T
2.2	$\pm 0.1, \pm 0.2, 0.3$ nH	7	100	7.00	8.6	0.15	0.08	900	MLG1005S2N2□T
2.4	$\pm 0.1, \pm 0.2, 0.3$ nH	7	100	7.00	8.2	0.15	0.08	800	MLG1005S2N4□T
2.7	$\pm 0.1, \pm 0.2, 0.3$ nH	7	100	6.00	7.3	0.15	0.08	800	MLG1005S2N7□T
3.0	$\pm 0.1, \pm 0.2, 0.3$ nH	7	100	5.50	6.8	0.20	0.09	800	MLG1005S3N0□T
3.3	$\pm 0.1, \pm 0.2, 0.3$ nH	8	100	5.00	6.1	0.20	0.09	800	MLG1005S3N3□T
3.6	$\pm 0.1, \pm 0.2, 0.3$ nH	8	100	5.00	6.7	0.20	0.09	700	MLG1005S3N6□T
3.9	$\pm 0.1, \pm 0.2, 0.3$ nH	8	100	5.00	6.5	0.20	0.11	700	MLG1005S3N9□T
4.3	$\pm 0.2, \pm 0.3$ nH	8	100	4.50	6.0	0.20	0.11	700	MLG1005S4N3□T
4.7	$\pm 0.2, \pm 0.3$ nH	8	100	4.50	5.4	0.25	0.12	700	MLG1005S4N7□T
5.1	$\pm 0.2, \pm 0.3$ nH	8	100	4.00	5.0	0.25	0.13	600	MLG1005S5N1□T
5.6	$\pm 0.2, \pm 0.3$ nH	8	100	4.00	5.3	0.25	0.14	600	MLG1005S5N6□T
6.2	$\pm 3\%, \pm 0.3$ nH	8	100	4.00	4.7	0.25	0.16	600	MLG1005S6N2□T
6.8	$\pm 3, \pm 5\%$	8	100	3.50	4.4	0.25	0.15	600	MLG1005S6N8□T
7.5	$\pm 3, \pm 5\%$	8	100	3.00	4.1	0.25	0.15	500	MLG1005S7N5□T
8.2	$\pm 3, \pm 5\%$	8	100	3.00	4.0	0.30	0.19	500	MLG1005S8N2□T
9.1	$\pm 3, \pm 5\%$	8	100	3.00	3.8	0.30	0.20	500	MLG1005S9N1□T
10	$\pm 3, \pm 5\%$	8	100	2.50	3.4	0.35	0.22	500	MLG1005S10N□T
12	$\pm 3, \pm 5\%$	8	100	2.50	3.0	0.40	0.25	400	MLG1005S12N□T
15	$\pm 3, \pm 5\%$	8	100	2.20	2.8	0.55	0.35	400	MLG1005S15N□T
18	$\pm 3, \pm 5\%$	8	100	2.00	2.5	0.60	0.40	350	MLG1005S18N□T
22	$\pm 3, \pm 5\%$	8	100	1.70	2.2	0.70	0.46	350	MLG1005S22N□T
27	$\pm 3, \pm 5\%$	8	100	1.60	2.0	0.80	0.53	300	MLG1005S27N□T
33	$\pm 3, \pm 5\%$	8	100	1.40	1.8	0.90	0.59	300	MLG1005S33N□T
39	$\pm 3, \pm 5\%$	8	100	1.20	1.6	1.00	0.65	250	MLG1005S39N□T
47	$\pm 3, \pm 5\%$	8	100	1.10	1.4	1.20	0.75	250	MLG1005S47N□T
56	$\pm 3, \pm 5\%$	8	100	1.00	1.3	1.30	0.83	200	MLG1005S56N□T
68	$\pm 3, \pm 5\%$	8	100	0.80	1.1	1.50	0.87	200	MLG1005S68N□T
82	$\pm 3, \pm 5\%$	8	100	0.70	1.0	1.60	1.01	200	MLG1005S82N□T
100	$\pm 3, \pm 5\%$	8	100	0.70	0.9	2.00	1.37	200	MLG1005SR10□T
120	$\pm 3, \pm 5\%$	8	100	0.60	0.8	2.20	1.48	150	MLG1005SR12□T
150	$\pm 3, \pm 5\%$	8	100	0.55	0.7	3.50	2.44	150	MLG1005SR15□T
180	$\pm 3, \pm 5\%$	8	100	0.50	0.6	3.80	2.88	150	MLG1005SR18□T
220	$\pm 3, \pm 5\%$	8	100	0.45	0.5	4.20	3.02	100	MLG1005SR22□T
270	$\pm 3, \pm 5\%$	8	100	0.40	0.5	4.80	3.54	100	MLG1005SR27□T
330	$\pm 3, \pm 5\%$	6	50	0.35	0.4	7.00	5.21	50	MLG1005SR33□T
390	$\pm 3, \pm 5\%$	6	50	0.30	0.4	8.00	5.97	50	MLG1005SR39□T

\* □: Please specify inductance tolerance, B ( $\pm 0.1$ nH), C ( $\pm 0.2$ nH), S ( $\pm 0.3$ nH), H ( $\pm 3\%$ ) or J ( $\pm 5\%$ ).

## • Test equipment

Inductance Q : HP4291A+16193A, or equivalent

SRF: HP8720C, or equivalent

Rdc: YOKOGAWA TYPE7561, or equivalent

• Rated current : Value obtained when current flows and temperature has risen to under 20°C.

**L, Q vs. FREQUENCY CHARACTERISTICS**

Part No.	Inductance(nH)typ.					Q typ.				
	500MHz	800MHz	1.8GHz	2.0GHz	2.4GHz	500MHz	800MHz	1.8GHz	2.0GHz	2.4GHz
MLG1005S0N3□*T	0.3	0.3	0.3	0.3	0.3	39	48	99	117	127
MLG1005S0N4□T	0.4	0.4	0.4	0.4	0.4	41	48	98	109	117
MLG1005S0N5□T	0.5	0.5	0.5	0.5	0.5	26	32	58	63	69
MLG1005S0N6□T	0.6	0.6	0.6	0.6	0.6	22	27	46	49	53
MLG1005S0N7□T	0.7	0.7	0.7	0.7	0.7	22	28	45	49	54
MLG1005S0N8□T	0.8	0.8	0.8	0.8	0.8	26	34	57	60	66
MLG1005S0N9□T	0.9	0.8	0.8	0.8	0.8	21	27	44	47	53
MLG1005S1N0□T	0.9	0.9	0.9	0.9	0.9	22	29	48	50	56
MLG1005S1N1□T	1.0	1.0	1.0	1.0	1.0	23	29	47	50	57
MLG1005S1N2□T	1.1	1.1	1.1	1.1	1.1	23	29	48	50	56
MLG1005S1N3□T	1.2	1.2	1.2	1.2	1.2	22	27	44	47	53
MLG1005S1N5□T	1.4	1.4	1.4	1.5	1.5	23	29	47	50	56
MLG1005S1N6□T	1.5	1.5	1.5	1.6	1.6	23	29	46	49	54
MLG1005S1N8□T	1.7	1.7	1.7	1.7	1.7	20	26	41	43	49
MLG1005S2N0□T	1.9	1.9	1.9	1.9	1.9	21	25	41	43	48
MLG1005S2N2□T	2.1	2.1	2.1	2.1	2.2	22	27	44	47	52
MLG1005S2N4□T	2.3	2.3	2.3	2.3	2.4	21	26	42	44	49
MLG1005S2N7□T	2.6	2.6	2.6	2.7	2.7	22	27	43	45	50
MLG1005S3N0□T	2.9	2.9	3.0	3.0	3.1	24	29	47	49	54
MLG1005S3N3□T	3.2	3.2	3.3	3.4	3.5	24	30	46	48	53
MLG1005S3N6□T	3.4	3.4	3.6	3.6	3.8	21	26	40	42	46
MLG1005S3N9□T	3.7	3.7	3.9	3.9	4.1	22	28	43	45	50
MLG1005S4N3□T	4.1	4.1	4.3	4.4	4.6	24	30	47	49	53
MLG1005S4N7□T	4.5	4.5	4.8	4.9	5.2	23	30	45	47	50
MLG1005S5N1□T	4.9	4.9	5.4	5.6	6.1	23	29	42	43	44
MLG1005S5N6□T	5.4	5.4	5.8	5.9	6.3	22	28	42	43	45
MLG1005S6N2□T	6.0	6.0	6.8	7.1	7.8	24	29	42	43	43
MLG1005S6N8□T	6.5	6.6	7.4	7.8	8.6	23	28	40	41	41
MLG1005S7N5□T	7.2	7.4	8.6	9.2	10.5	24	30	41	41	39
MLG1005S8N2□T	7.9	8.0	9.3	9.9	11.3	23	28	38	38	36
MLG1005S9N1□T	8.8	9.0	10.8	11.6	13.7	24	30	40	39	36
MLG1005S10N□T	9.7	9.9	12.4	13.5	16.7	24	30	37	36	31
MLG1005S12N□T	11.7	12.1	16.2	18.3	25.5	23	29	33	31	23
MLG1005S15N□T	14.7	15.3	22.0	26.0	41.7	23	28	29	26	17
MLG1005S18N□T	17.7	18.6	29.0	36.1	74.4	23	28	26	22	11
MLG1005S22N□T	21.8	23.3	44.5	65.1	341.5	22	27	21	14	2
MLG1005S27N□T	27.0	29.6	92.4	317.8		20	23	10	3	
MLG1005S33N□T	33.5	37.8	314.7			20	23	3		
MLG1005S39N□T	40.3	46.9				20	21			
MLG1005S47N□T	50.2	63.2				19	20			
MLG1005S56N□T	60.9	80.2				19	18			
MLG1005S68N□T	75.8	107.5				17	15			
MLG1005S82N□T	96.9	164.8				16	11			
MLG1005SR10□T	128.9	325.8				14	6			
MLG1005SR12□T	175.2					12	1			
MLG1005SR15□T	284.7					11				
MLG1005SR18□T	422.4					8				
MLG1005SR22□T	874.6					5				
MLG1005SR27□T						1				
MLG1005SR33□T										
MLG1005SR39□T										

\* □: Please specify inductance tolerance, B ( $\pm 0.1$ nH), C ( $\pm 0.2$ nH), S ( $\pm 0.3$ nH), H ( $\pm 3\%$ ) or J ( $\pm 5\%$ ).

### TYPICAL ELECTRICAL CHARACTERISTICS INDUCTANCE vs. FREQUENCY CHARACTERISTICS

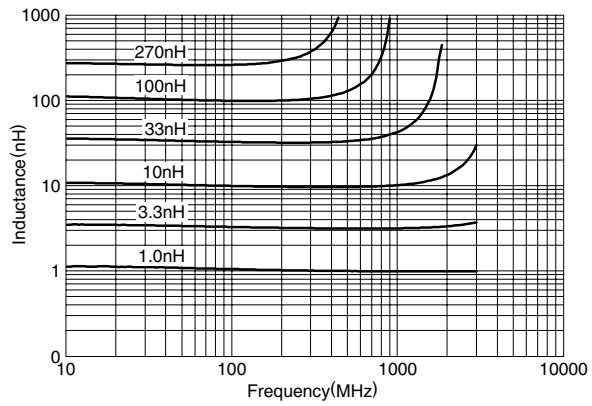

### Q vs. FREQUENCY CHARACTERISTICS

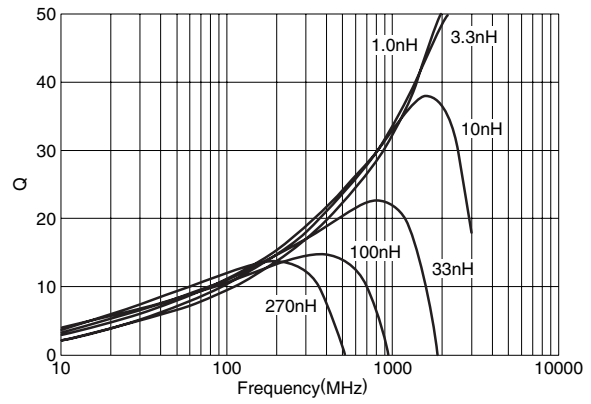

• All specifications are subject to change without notice.

## MLG Series MLG1005M Type (For Wireless LAN & Bluetooth)

### FEATURES

- Nominal inductance values are supported from 0.6 to 5.6nH.
- Provides high Q characteristics.
- Advanced monolithic structure is formed using a multilayering and sintering process with ceramic and conductive materials for high-frequency.
- The products contain no lead and also support lead-free soldering.
- It is a product conforming to RoHS directive.

### APPLICATIONS

The most suitable in high frequency circuit of 2.4GHz and 5GHz wireless LAN & Bluetooth.

### SHAPES AND DIMENSIONS

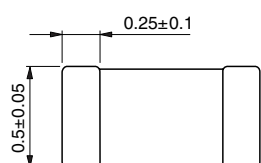
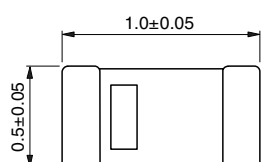

Weight: 1mg

### RECOMMENDED PC BOARD PATTERN

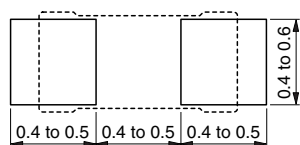

Dimensions in mm



### RECOMMENDED SOLDERING CONDITION REFLOW SOLDERING

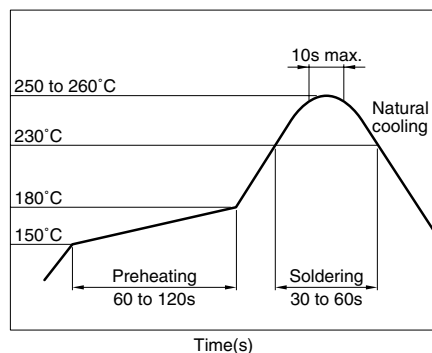

### PRODUCT IDENTIFICATION

MLG	1005	M	2N2	B	T
(1)	(2)	(3)	(4)	(5)	(6)

(1) Series name

(2) Dimensions

1005 1.0×0.5mm(L×W)

(3) Material code

(4) Inductance value

2N2	2.2nH
5N6	5.6nH

(5) Inductance tolerance

B ±0.1nH

(6) Packaging style

T Taping (reel)

### SPECIFICATIONS

Operating temperature range	-55 to +125°C
Storage temperature range	-55 to +125°C [Unit of products]

### PACKAGING STYLE AND QUANTITIES

Packaging style	Quantity
Taping	15000 pieces/reel

### HANDLING AND PRECAUTIONS

- Before soldering, be sure to preheat components.  
The preheating temperature should be set so that the temperature difference between the solder temperature and product temperature does not exceed 150°C.
- After mounting components onto the printed circuit board, do not apply stress through board bending or mishandling.
- When hand soldering, apply the soldering iron to the printed circuit board only. Temperature of the iron tip should not exceed 300°C. Soldering time should not exceed 3 seconds.

### PACKAGING STYLES

#### REEL DIMENSIONS

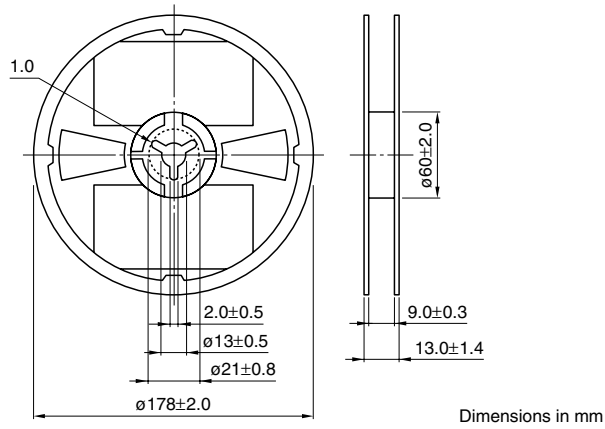

#### TAPE DIMENSIONS

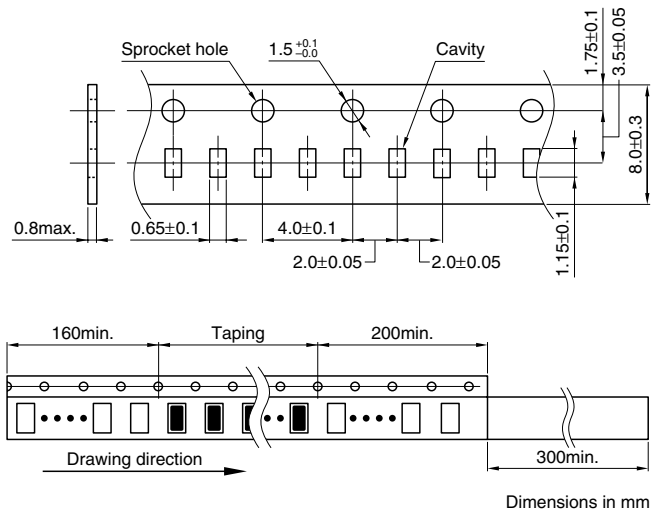

• All specifications are subject to change without notice.