



# Low-Cost, Low-Power, Ultra-Small, 3V/5V, 500MHz Single-Supply Op Amps with Rail-to-Rail Outputs

MAX4412/MAX4413

## General Description

The MAX4412 single and MAX4413 dual operational amplifiers are unity-gain-stable devices that combine high-speed performance, low supply current, and ultra-small packaging. Both devices operate from a single +2.7V to +5.5V supply, have Rail-to Rail® outputs, and exhibit a common-mode input voltage range that extends from 100mV below ground to within +1.5V of the positive supply rail.

The MAX4412/MAX4413 achieve a 500MHz -3dB bandwidth and a 220V/μs slew rate while consuming only 1.7mA of supply current per amplifier. This makes the MAX4412/MAX4413 ideal for low-power/low-voltage, high-speed portable applications such as video, communications, and instrumentation.

For systems requiring tighter specifications, Maxim offers the MAX4414–MAX4419 family of operational amplifiers. The MAX4414–MAX4419 are laser trimmed versions of the MAX4412/MAX4413 and include compensated and uncompensated devices.

The MAX4412 is available in ultra-small 5-pin SC70 and SOT23 packages, while the MAX4413 is available in a space-saving 8-pin SOT23.

## Applications

- Battery-Powered Instruments
- Portable Communications
- Keyless Entry Systems
- Cellular Telephones
- Video Line Drivers
- Baseband Applications

*Rail-to-Rail is a registered trademark of Nippon Motorola, Ltd.*

## Typical Operating Characteristic

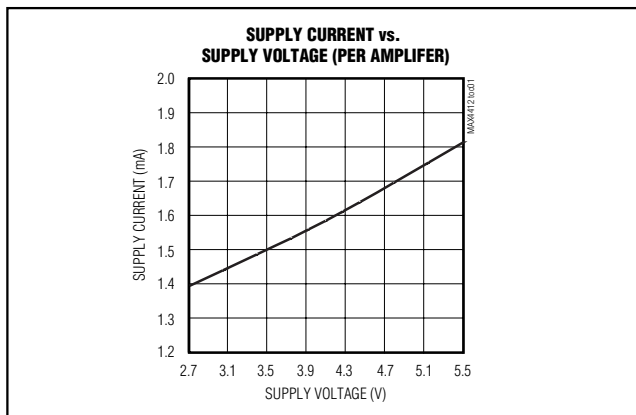

## Features

- ◆ Ultra-Low 1.7mA Supply Current
- ◆ Low Cost
- ◆ Single +3V/+5V Operation
- ◆ High Speed
  - 500MHz -3dB Bandwidth
  - 50MHz 0.1dB Gain Flatness
  - 220V/μs Slew Rate
- ◆ Rail-to-Rail Outputs
- ◆ Input Common-Mode Range Extends Beyond V<sub>EE</sub>
- ◆ Low Differential Gain/Phase: 0.01%/0.03°
- ◆ Low Distortion at 5MHz
  - 93dBc SFDR
  - 0.003% Total Harmonic Distortion
- ◆ Ultra-Small SC70-5, SOT23-5, and SOT23-8 Packages

## Ordering Information

PART	TEMP. RANGE	PIN-PACKAGE	TOP MARK
MAX4412EXK-T	-40°C to +85°C	5 SC70-5	ABH
MAX4412EUK-T	-40°C to +85°C	5 SOT23-5	ADOL
MAX4413EKA-T	-40°C to +85°C	8 SOT23-8	AADR

## Pin Configurations

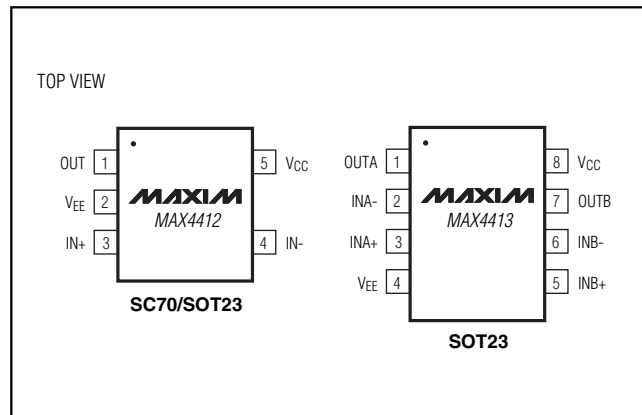

**For price, delivery, and to place orders, please contact Maxim Distribution at 1-888-629-4642, or visit Maxim's website at [www.maxim-ic.com](http://www.maxim-ic.com).**

# Low-Cost, Low-Power, Ultra-Small, 3V/5V, 500MHz Single-Supply Op Amps with Rail-to-Rail Outputs

## ABSOLUTE MAXIMUM RATINGS

Supply Voltage ( $V_{CC}$ to $V_{EE}$ ).....	+6V	5-Pin SOT23 (derate 7.1mW/°C above +70°C).....	571mW
Differential Input Voltage .....	±2.5V	8-Pin SOT23 (derate 9.1mW/°C above +70°C).....	727mW
$IN_-$ , $IN_+$ , $OUT_-$ .....	( $V_{CC} + 0.3V$ ) to ( $V_{EE} - 0.3V$ )	Operating Temperature Range .....	-40°C to +85°C
Current into Input Pins .....	±20mA	Junction Temperature .....	+150°C
Output Short-Circuit Duration to $V_{CC}$ or $V_{EE}$ .....	Continuous	Storage Temperature Range .....	-65°C to +150°C
Continuous Power Dissipation ( $T_A = +70^\circ C$ )		Lead Temperature (soldering, 10s) .....	+300°C
5-Pin SC70 (derate 3.1mW/°C above +70°C).....	247mW		

Stresses beyond those listed under "Absolute Maximum Ratings" may cause permanent damage to the device. These are stress ratings only, and functional operation of the device at these or any other conditions beyond those indicated in the operational sections of the specifications is not implied. Exposure to absolute maximum rating conditions for extended periods may affect device reliability.

## DC ELECTRICAL CHARACTERISTICS

( $V_{CC} = +2.7V$  to  $+5.5V$ ,  $V_{CM} = V_{CC}/2 - 0.75V$ ,  $V_{EE} = 0$ ,  $R_L = \infty$  to  $V_{CC}/2$ ,  $V_{OUT} = V_{CC}/2$ ,  $T_A = T_{MIN}$  to  $T_{MAX}$ , unless otherwise noted. Typical values are at  $T_A = +25^\circ C$ .) (Note 1)

PARAMETER	SYMBOL	CONDITIONS	MIN	TYP	MAX	UNITS
Operating Supply Voltage Range	$V_S$	Guaranteed by PSRR test	2.7		5.5	V
Quiescent Supply Current (per amplifier)	$I_S$	$V_{CC} = +5V$		1.7	3.5	mA
		$V_{CC} = +3V$		1.5		
Input Common Mode Voltage Range	$V_{CM}$	Guaranteed by CMRR test	$V_{EE} - 0.1$		$V_{CC} - 1.5$	V
Input Offset Voltage	$V_{OS}$			0.4	9	mV
Input Offset Voltage Temperature Coefficient	$TC_{VOS}$			3		$\mu V/^\circ C$
Input Offset Voltage Matching		MAX4413		±1		mV
Input Bias Current	$I_B$			1.6	4	$\mu A$
Input Offset Current	$I_{OS}$			0.1	0.7	$\mu A$
Input Resistance	$R_{IN}$	Differential mode, $-0.04V \leq (V_{IN+} - V_{IN-}) \leq +0.04V$		60		k $\Omega$
		Common mode, $V_{EE} - 0.1V < V_{CM} < V_{CC} - 1.5V$		16		M $\Omega$
Common Mode Rejection Ratio	CMRR	$V_{EE} - 0.1V < V_{CM} < V_{CC} - 1.5V$	60	94		dB
Open-Loop Gain	$A_{VOL}$	$V_{CC} = +5V$	$+0.2V \leq V_{OUT} \leq +4.8V$ , $R_L = 10k\Omega$	78	93	dB
			$+0.4V \leq V_{OUT} \leq +4.6V$ , $R_L = 1k\Omega$	68	80	
			$+1V \leq V_{OUT} \leq +4V$ , $R_L = 150\Omega$		65	
		$V_{CC} = +3V$	$+0.2V \leq V_{OUT} \leq +2.8V$ , $R_L = 10k\Omega$		90	
			$+0.25V \leq V_{OUT} \leq +2.75V$ , $R_L = 1k\Omega$		78	
			$+0.5V \leq V_{OUT} \leq +2.5V$ , $R_L = 150\Omega$		62	

# Low-Cost, Low-Power, Ultra-Small, 3V/5V, 500MHz Single-Supply Op Amps with Rail-to-Rail Outputs

MAX4412/MAX4413

## DC ELECTRICAL CHARACTERISTICS (continued)

( $V_{CC} = +2.7V$  to  $+5.5V$ ,  $V_{CM} = V_{CC}/2 - 0.75V$ ,  $V_{EE} = 0$ ,  $R_L = \infty$  to  $V_{CC}/2$ ,  $V_{OUT} = V_{CC}/2$ ,  $T_A = T_{MIN}$  to  $T_{MAX}$ , unless otherwise noted. Typical values are at  $T_A = +25^\circ C$ .) (Note 1)

PARAMETER	SYMBOL	CONDITIONS	MIN	TYP	MAX	UNITS	
Output Voltage Swing	$V_{OUT}$	$V_{CC} = +5V$	$R_L = 10k\Omega$	$V_{CC} - V_{OH}$	0.085		V
				$V_{OL} - V_{EE}$	0.015		
			$R_L = 1k\Omega$	$V_{CC} - V_{OH}$	0.105	0.275	
				$V_{OL} - V_{EE}$	0.035	0.125	
			$R_L = 150\Omega$	$V_{CC} - V_{OH}$	0.385		
				$V_{OL} - V_{EE}$	0.150		
		$V_{CC} = +3V$	$R_L = 10k\Omega$	$V_{CC} - V_{OH}$	0.06		
				$V_{OL} - V_{EE}$	0.01		
			$R_L = 1k\Omega$	$V_{CC} - V_{OH}$	0.075		
				$V_{OL} - V_{EE}$	0.025		
$R_L = 150\Omega$	$V_{CC} - V_{OH}$	0.275					
	$V_{OL} - V_{EE}$	0.070					
Output Current	$I_{OUT}$	$R_L = 20\Omega$ connected to $V_{CC}$ or $V_{EE}$ , $V_{CC} = +5V$	$\pm 25$	$\pm 75$		mA	
Output Short-Circuit Current	$I_{SC}$	Sinking or sourcing		$\pm 85$		mA	
Power Supply Rejection Ratio	PSRR	$V_{CC} = +2.7V$ to $+5.5V$ , $V_{CM} = 0$ , $V_{OUT} = 2V$	60	77		dB	

## AC ELECTRICAL CHARACTERISTICS

( $V_{CC} = +5V$ ,  $V_{EE} = 0$ ,  $V_{CM} = +1.75V$ ,  $R_L = 1k\Omega$  connected to  $V_{CC}/2$ ,  $C_L = 5pF$ ,  $A_{VCL} = +1V/V$ ,  $T_A = +25^\circ C$ , unless otherwise noted.)

PARAMETER	SYMBOL	CONDITIONS	MIN	TYP	MAX	UNITS
Small Signal -3dB Bandwidth	$BW_{SS}$	$V_{OUT} = 100mVp-p$		500		MHz
Large Signal -3dB Bandwidth	$BW_{LS}$	$V_{OUT} = 2Vp-p$		30		MHz
Bandwidth for 0.1dB Flatness	$BW_{0.1dB}$	$V_{OUT} = 100mVp-p$		50		MHz
		$V_{OUT} = 2Vp-p$		16		
Slew Rate	SR	$V_{OUT} = 2V$ step		220		V/ $\mu s$
Rise/Fall Time	$t_R, t_F$	$V_{OUT} = 2V$ step, 10% to 90%		14		ns
Settling Time to 0.1%	$t_s 1\%$	$V_{OUT} = 2V$ step		100		ns
Spurious-Free Dynamic Range	SFDR	$V_{CC} = +5V$ , $f_C = 5MHz$ , $V_{OUT} = 1Vp-p$		-84		dBc
		$V_{CC} = +3V$ , $f_C = 5MHz$ , $V_{OUT} = 1Vp-p$		-93		

# Low-Cost, Low-Power, Ultra-Small, 3V/5V, 500MHz Single-Supply Op Amps with Rail-to-Rail Outputs

## AC ELECTRICAL CHARACTERISTICS (continued)

( $V_{CC} = +5V$ ,  $V_{EE} = 0$ ,  $V_{CM} = +1.75V$ ,  $R_L = 1k\Omega$  connected to  $V_{CC}/2$ ,  $C_L = 5pF$ ,  $A_{VCL} = +1V/V$ ,  $T_A = +25^\circ C$ , unless otherwise noted.)

PARAMETER	SYMBOL	CONDITIONS	MIN	TYP	MAX	UNITS
2 <sup>nd</sup> Harmonic Distortion		$V_{CC} = +5V$ , $f_C = 5MHz$ , $V_{OUT} = 1Vp-p$		-84		dBc
		$V_{CC} = +3V$ , $f_C = 5MHz$ , $V_{OUT} = 1Vp-p$		-93		
3 <sup>rd</sup> Harmonic Distortion		$V_{CC} = +5V$ , $f_C = 5MHz$ , $V_{OUT} = 1Vp-p$		-95		dBc
		$V_{CC} = +3V$ , $f_C = 5MHz$ , $V_{OUT} = 1Vp-p$		-95		
Total Harmonic Distortion	THD	$V_{CC} = +5V$ , $f_C = 5MHz$ , $V_{OUT} = 1Vp-p$		0.007		%
		$V_{CC} = +3V$ , $f_C = 5MHz$ , $V_{OUT} = 1Vp-p$		0.003		
Two-Tone, Third-Order Intermodulation Distortion	IP3	$f_1 = 10MHz$ , $f_2 = 9.9MHz$		-67		dBc
Differential Gain Error	DG	$R_L = 150\Omega$ , NTSC	$A_V = +1V/V$		0.03	%
			$A_V = +2V/V$		0.01	
Differential Phase Error	DP	$R_L = 150\Omega$ , NTSC	$A_V = +1V/V$		0.13	degrees
			$A_V = +2V/V$		0.03	
Gain Matching		MAX4413, $V_{OUT} = 100mVp-p$ , $f \leq 10MHz$		0.1		dB
Phase Matching		MAX4413, $V_{OUT} = 100mVp-p$ , $f \leq 10MHz$		0.1		degrees
Input Noise-Voltage Density	$e_n$	$f = 10kHz$		13		$nV/\sqrt{Hz}$
Input Noise-Current Density	$I_n$	$f = 10kHz$		0.7		$pA/\sqrt{Hz}$
Input Capacitance	$C_{IN}$			1.8		pF
Output Impedance	$Z_{OUT}$	$f = 1MHz$		0.7		$\Omega$
Capacitive Load Drive		No sustained oscillations		120		pF
Power-Up 1% Settling Time (Note 2)				1.2	100	$\mu s$
Crosstalk	$X_{TALK}$	MAX4413, $f = 10MHz$ , $V_{OUT} = 2Vp-p$		-82		dB

**Note 1:** All devices are 100% production tested at  $T_A = +25^\circ C$ . Specifications over temperature are guaranteed by design.

**Note 2:** Guaranteed by design.

# Low-Cost, Low-Power, Ultra-Small, 3V/5V, 500MHz Single-Supply Op Amps with Rail-to-Rail Outputs

## Typical Operating Characteristics

( $V_{CC} = +5V$ ,  $V_{EE} = 0$ ,  $V_{CM} = +1.75V$ ,  $A_{VCL} = +1V/V$ ,  $R_F = 24\Omega$ ,  $R_L = 1k\Omega$  to  $V_{CC}/2$ ,  $C_L = 5pF$ ,  $T_A = +25^\circ C$ , unless otherwise noted.)

MAX4412/MAX4413

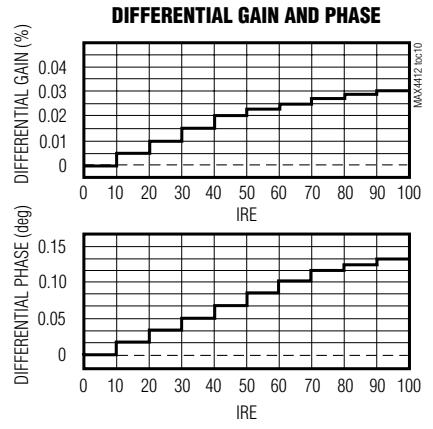
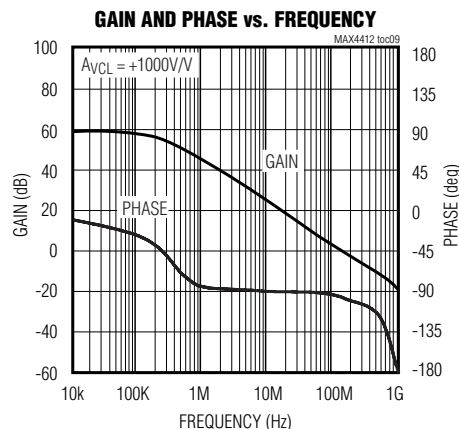
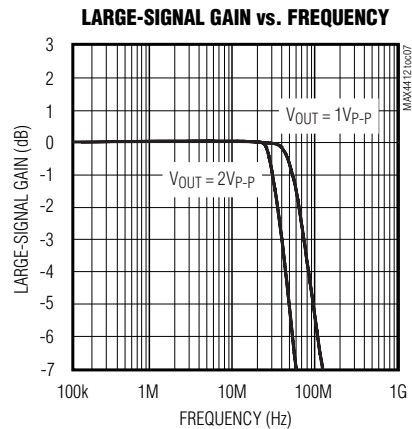
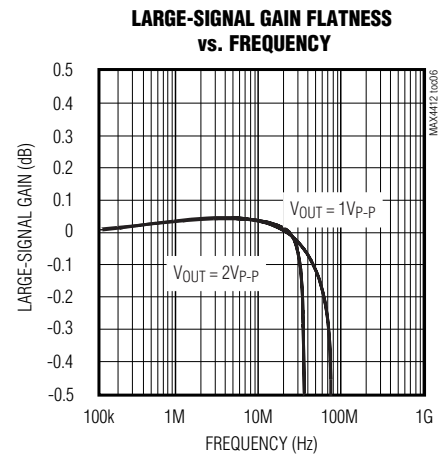
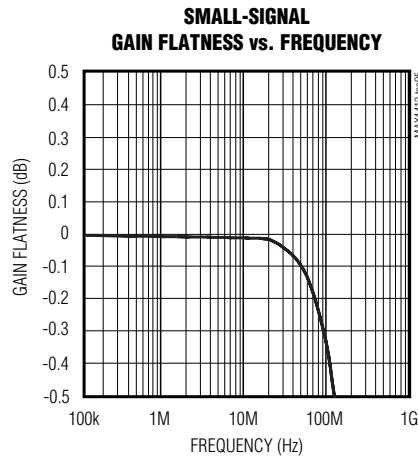
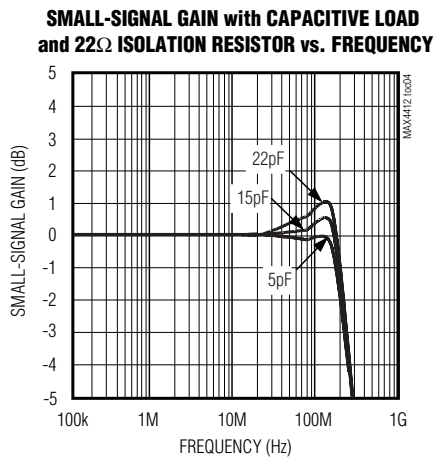
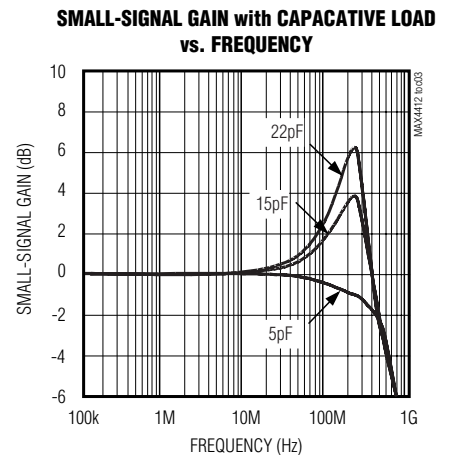
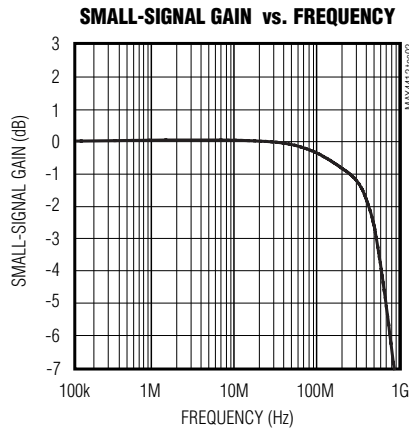
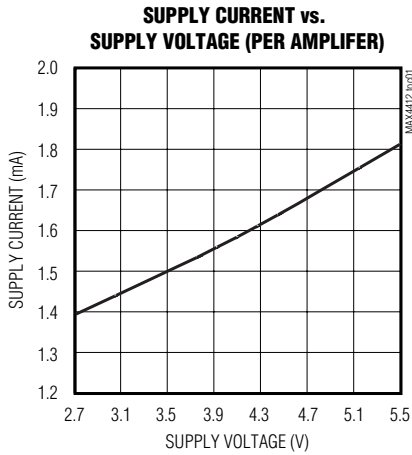

# Low-Cost, Low-Power, Ultra-Small, 3V/5V, 500MHz Single-Supply Op Amps with Rail-to-Rail Outputs

## Typical Operating Characteristics (continued)

( $V_{CC} = +5V$ ,  $V_{EE} = 0$ ,  $V_{CM} = 1.75V$ ,  $A_{VCL} = +1V/V$ ,  $R_F = 24\Omega$ ,  $R_L = 1k\Omega$  to  $V_{CC}/2$ ,  $C_L = 5pF$ ,  $T_A = +25^\circ C$ , unless otherwise noted.)

**SMALL-SIGNAL PULSE RESPONSE**

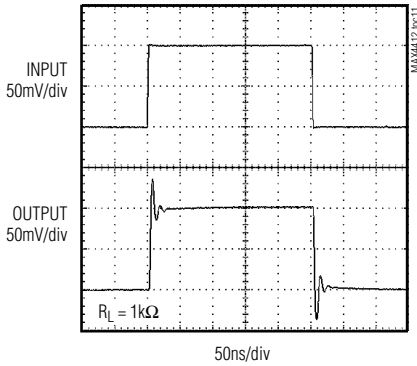

**LARGE-SIGNAL PULSE RESPONSE**

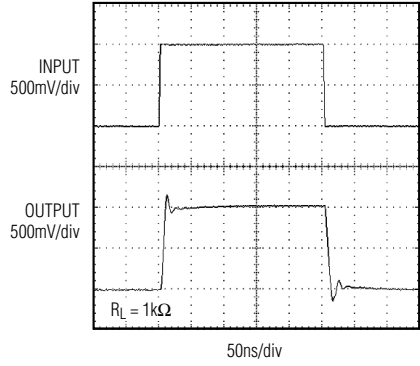

**LARGE-SIGNAL PULSE RESPONSE**

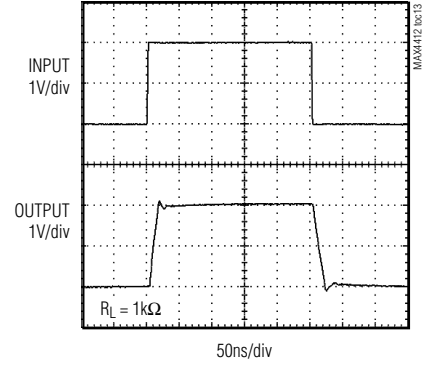

**SMALL-SIGNAL PULSE RESPONSE**

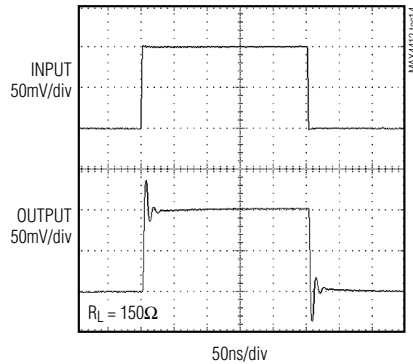

**LARGE-SIGNAL PULSE RESPONSE**

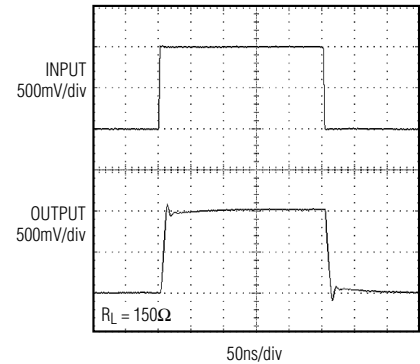

**SMALL-SIGNAL PULSE RESPONSE (CL = 15pF)**

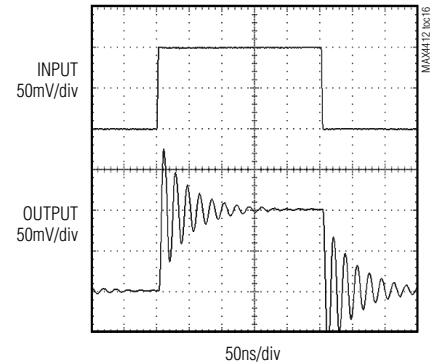

**MAX4412/MAX4413  
CLOSED-LOOP OUTPUT IMPEDANCE  
vs. FREQUENCY**

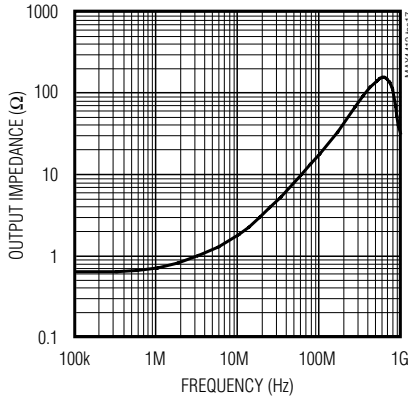

**MAX4413  
CROSSTALK vs. FREQUENCY**

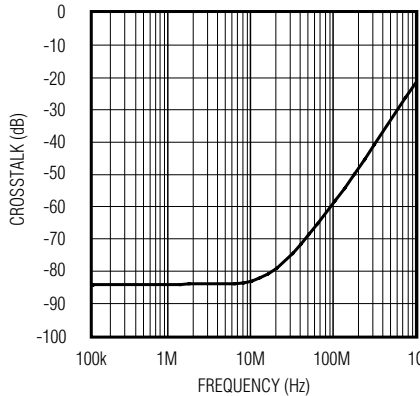

**SMALL SIGNAL BANDWIDTH  
vs. LOAD RESISTANCE**

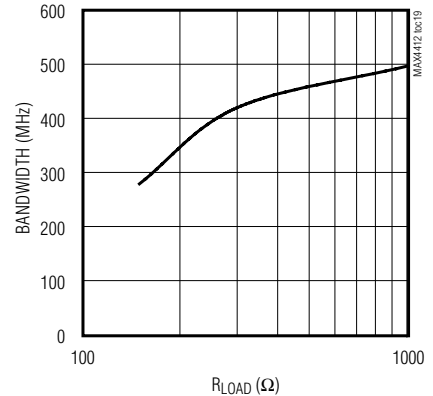

# Low-Cost, Low-Power, Ultra-Small, 3V/5V, 500MHz Single-Supply Op Amps with Rail-to-Rail Outputs

## Typical Operating Characteristics (continued)

( $V_{CC} = +5V$ ,  $V_{EE} = 0$ ,  $V_{CM} = 1.75V$ ,  $A_{VCL} = +1V/V$ ,  $R_F = 24\Omega$ ,  $R_L = 1k\Omega$  to  $V_{CC}/2$ ,  $C_L = 5pF$ ,  $T_A = +25^\circ C$ , unless otherwise noted.)

MAX4412/MAX4413

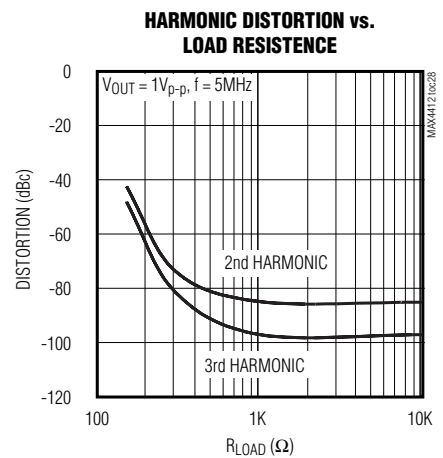
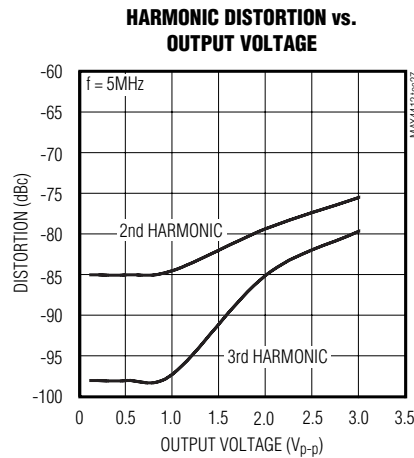
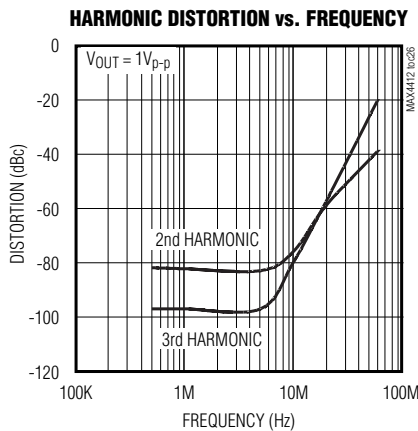
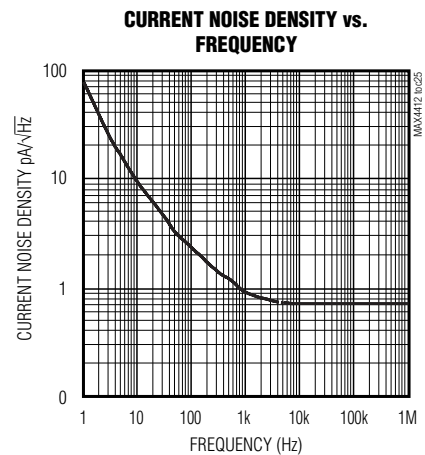
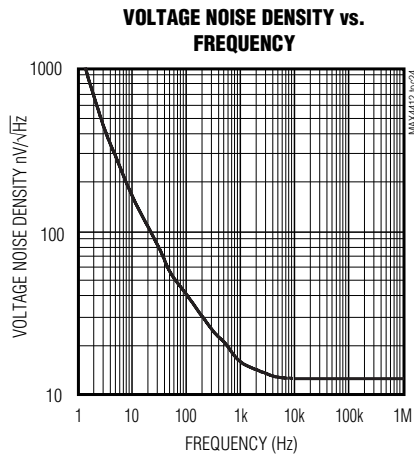
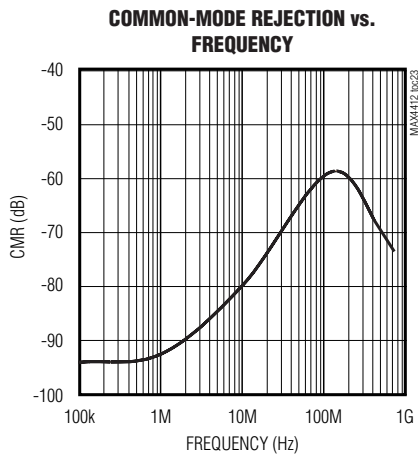
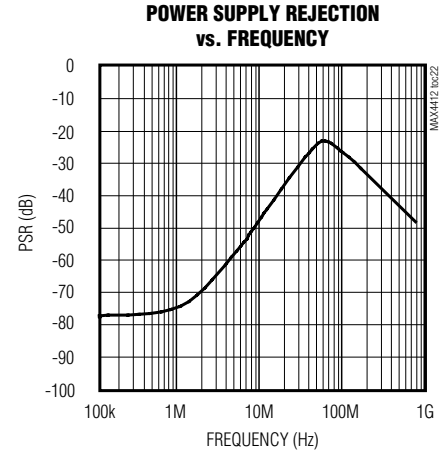
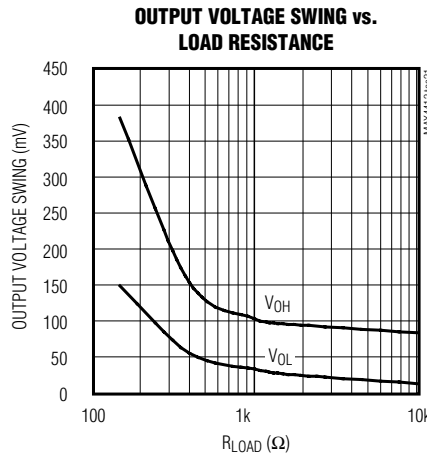
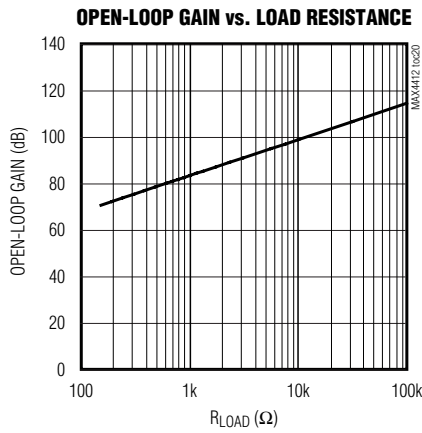

# Low-Cost, Low-Power, Ultra-Small, 3V/5V, 500MHz Single-Supply Op Amps with Rail-to-Rail Outputs

## Typical Operating Characteristics (continued)

( $V_{CC} = +5V$ ,  $V_{EE} = 0$ ,  $V_{CM} = 1.75V$ ,  $A_{VCL} = +1V/V$ ,  $R_F = 24\Omega$ ,  $R_L = 1k\Omega$  to  $V_{CC}/2$ ,  $C_L = 5pF$ ,  $T_A = +25^\circ C$ , unless otherwise noted.)

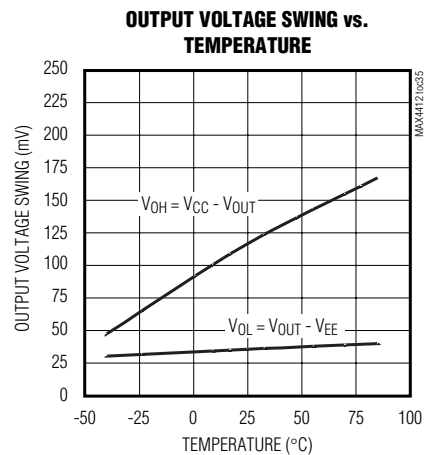
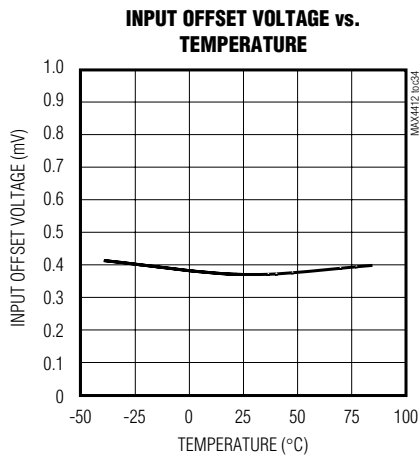
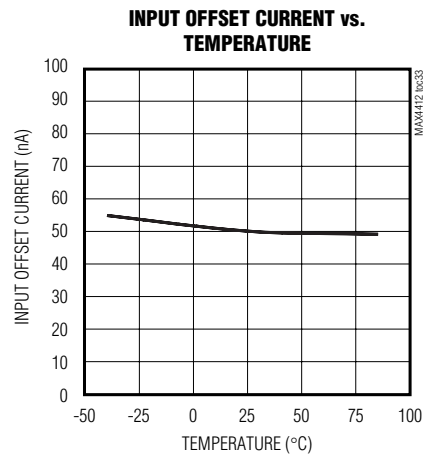
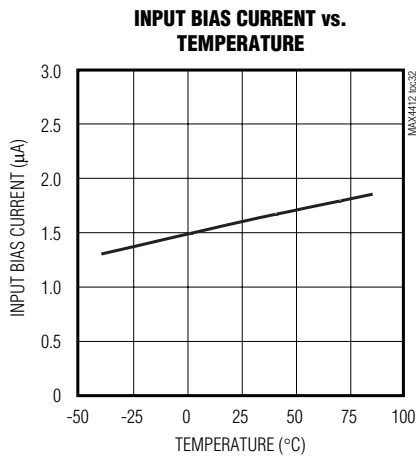
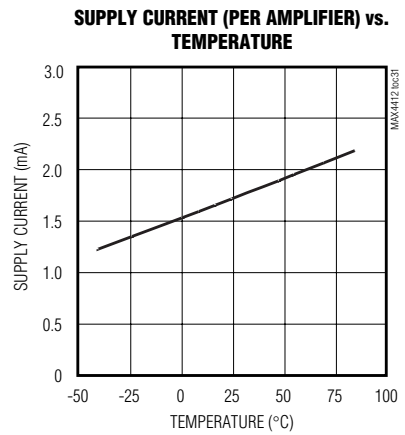
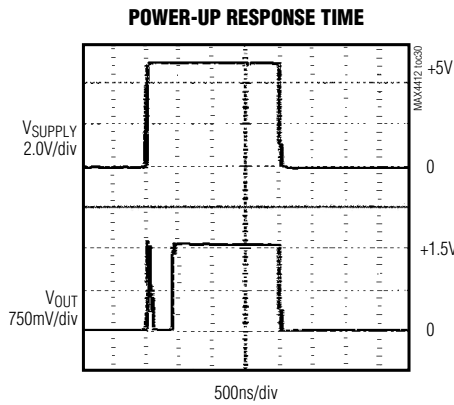
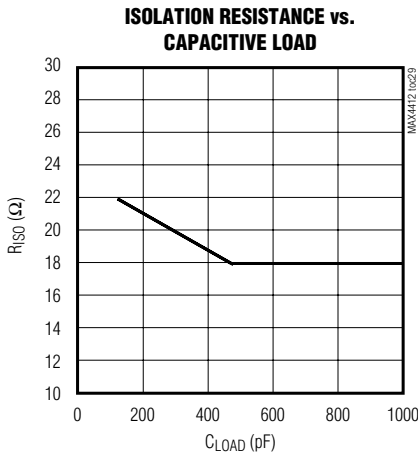



# Low-Cost, Low-Power, Ultra-Small, 3V/5V, 500MHz Single-Supply Op Amps with Rail-to-Rail Outputs

## Pin Description

MAX4412/MAX4413

PIN		NAME	FUNCTION
MAX4412	MAX4413		
1	—	OUT	Amplifier Output
—	1	OUTA	Amplifier A Output
—	7	OUTB	Amplifier B Output
2	4	VEE	Negative Power Supply
3	—	IN+	Amplifier Noninverting Input
—	3	INA+	Amplifier A Noninverting Input
—	5	INB+	Amplifier B Noninverting Input
4	—	IN-	Amplifier Inverting Input
—	2	INA-	Amplifier A Inverting Input
—	6	INB-	Amplifier B Inverting Input
5	8	VCC	Positive Power Supply

## Detailed Description

The MAX4412/MAX4413 single-supply, rail-to-rail, voltage-feedback amplifiers achieve 220V/ $\mu$ s slew rates and 500MHz -3dB bandwidths, while consuming only 1.7mA of supply current per amplifier. Excellent harmonic distortion and differential gain/phase performance make these amplifiers an ideal choice for a wide variety of video and RF signal-processing applications.

Internal feedback around the output stage ensures low open-loop output impedance, reducing gain sensitivity to load variations. This feedback also produces demand-driven current bias to the output transistors.

### Rail-to-Rail Outputs, Ground-Sensing Input

The MAX4412/MAX4413 input common-mode range extends from (VEE - 0.1V) to (VCC - 1.5V) with excellent common-mode rejection. Beyond this range, the amplifier output is a nonlinear function of the input, but does not undergo phase reversal or latchup.

The output swings to within 105mV of either power-supply rail with a 1k $\Omega$  load. Input ground sensing and rail-to-rail outputs substantially increase the dynamic range. With a symmetric input in a single +5V application, the input can swing 3.6Vp-p, and the output can swing 4.6Vp-p with minimal distortion.

### Output Capacitive Loading and Stability

The MAX4412/MAX4413 are optimized for AC performance. They are not designed to drive highly reactive loads. Such loads decrease phase margin and may

produce excessive ringing and oscillation. The use of an isolation resistor eliminates this problem (Figure 1). Figure 2 is a graph of the Optimal Isolation Resistor (R<sub>ISO</sub>) vs. Capacitive Load.

The Small Signal Gain vs. Frequency with Capacitive Load and No Isolation Resistor graph in the *Typical Operating Characteristics* shows how a capacitive load causes excessive peaking of the amplifier's frequency response if the capacitor is not isolated from the amplifier by a resistor. A small isolation resistor (usually 20 $\Omega$  to 30 $\Omega$ ) placed before the reactive load prevents ringing and oscillation. At higher capacitive loads, AC performance is controlled by the interaction of the load capacitance and the isolation resistor. The Small-Signal Gain vs. Frequency with Capacitive Load and 22 $\Omega$  Isolation Resistor graph shows the effect of a 22 $\Omega$  isolation resistor on closed-loop response.

Coaxial cable and other transmission lines are easily driven when properly terminated at both ends with their characteristic impedance. Driving back-terminated transmission lines essentially eliminates the line's capacitance.

## Applications Information

### Choosing Resistor Values

#### Unity-Gain Configuration

The MAX4412/MAX4413 are internally compensated for unity gain. When configured for unity gain, the devices require a 24 $\Omega$  feedback resistor (R<sub>F</sub>). This resistor improves AC response by reducing the Q of the parallel LC circuit formed by the parasitic feedback capacitance and inductance.

# Low-Cost, Low-Power, Ultra-Small, 3V/5V, 500MHz Single-Supply Op Amps with Rail-to-Rail Outputs

## Inverting and Noninverting Configurations

Select the gain-setting feedback ( $R_F$ ) and input ( $R_G$ ) resistor values that best fit the application. Large resistor values increase voltage noise and interact with the amplifier's input and PC board capacitance. This can generate undesirable poles and zeros and decrease bandwidth or cause oscillations. For example, a noninverting gain-of-two configuration ( $R_F = R_G$ ) using  $1k\Omega$  resistors, combined with  $1.8pF$  of amplifier input capacitance and  $1pF$  of PC board capacitance, causes a pole at  $114MHz$ . Since this pole is within the amplifier bandwidth, it jeopardizes stability. Reducing the  $1k\Omega$  resistors to  $100\Omega$  extends the pole frequency to  $1.14GHz$ , but could limit output swing by adding  $200\Omega$  in parallel with the amplifier's load resistor.

**Note:** For high-gain applications where output offset voltage is a consideration, choose  $R_S$  to be equal to the parallel combination of  $R_F$  and  $R_G$  (Figures 3a and 3b):

$$R_S = \frac{R_F \times R_G}{R_F + R_G}$$

## Video Line Driver

The MAX4412/MAX4413 are designed to minimize differential gain error and differential phase error to  $0.01\%/0.03^\circ$  respectively, making them ideal for driving video loads.

## Active Filters

The low distortion and high bandwidth of the MAX4412/MAX4413 make them ideal for use in active filter circuits. Figure 4 is a  $15MHz$  lowpass, multiple-feedback active filter using the MAX4412.

$$GAIN = \frac{R_2}{R_1}$$

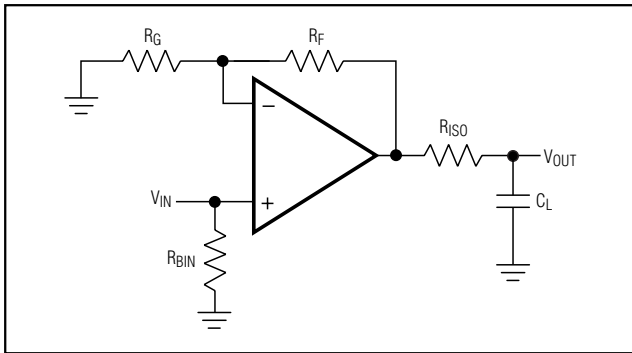

Figure 1. Driving a Capacitive Load Through an Isolation Resistor

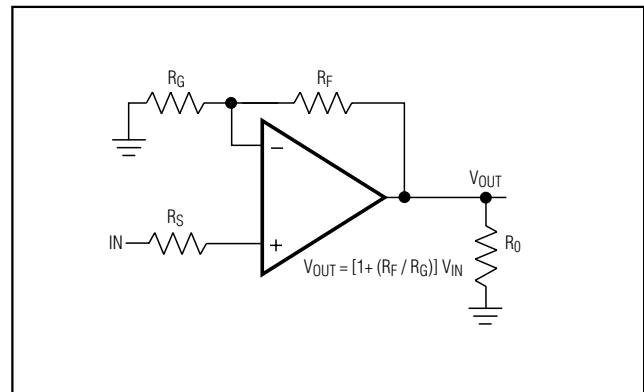

Figure 3a. Noninverting Gain Configuration

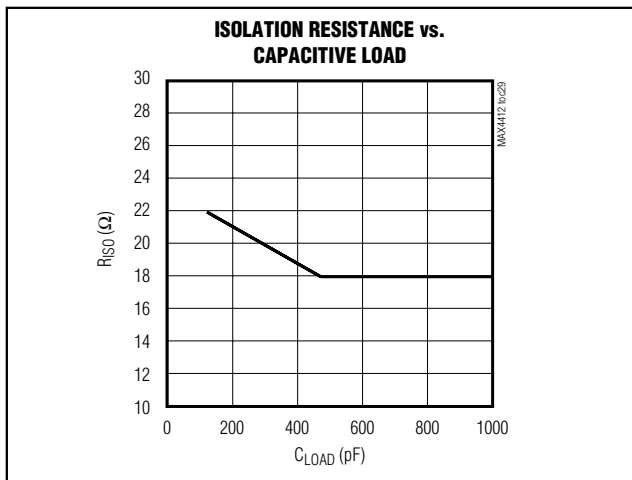

Figure 2. Isolation Resistance vs. Capacitive Load

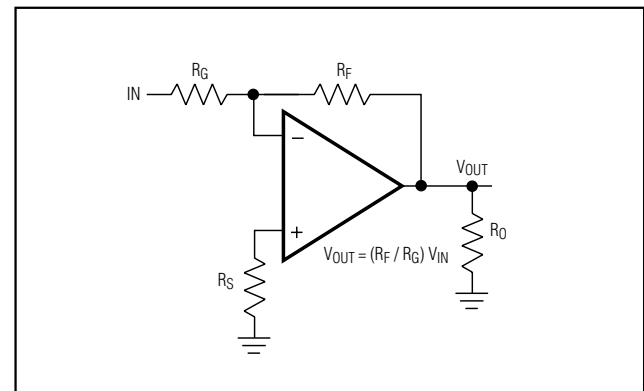

Figure 3b. Inverting Gain Configuration

# Low-Cost, Low-Power, Ultra-Small, 3V/5V, 500MHz Single-Supply Op Amps with Rail-to-Rail Outputs

$$f_0 = \frac{1}{2\pi} \times \sqrt{\frac{1}{R2 \times R3 \times C1 \times C2}}$$
$$Q = \frac{C2}{\sqrt{C1 \times C2 \times R2 \times R3} \left( \frac{1}{R1} + \frac{1}{R2} + \frac{1}{R3} \right)}$$

## ADC Input Buffer

Input buffer amplifiers can be a source of significant errors in high-speed analog-to-digital converter (ADC) applications. The input buffer is usually required to rapidly charge and discharge the ADC's input, which is often capacitive (see *Output Capacitive Loading and Stability*). In addition, since a high-speed ADC's input impedance often changes very rapidly during the conversion cycle, measurement accuracy must be maintained using an amplifier with very low output impedance at high frequencies. The combination of high speed, fast slew rate, low noise, and a low and stable distortion overload makes the MAX4412/MAX4413 ideally suited for use as buffer amplifiers in high-speed ADC applications.

## Layout and Power-Supply Bypassing

These amplifiers operate from a single +2.7V to +5.5V power supply. Bypass  $V_{CC}$  to ground with a 0.1 $\mu$ F capacitor as close to the pin as possible.

Maxim recommends using microstrip and stripline techniques to obtain full bandwidth. Design the PC board for a frequency greater than 1GHz to prevent amplifier performance degradation due to board parasitics. Avoid large parasitic capacitances at inputs and outputs. Whether or not a constant-impedance board is used, observe the following guidelines:

- Do not use wire-wrap boards due to their high inductance.
- Do not use IC sockets because of the increased parasitic capacitance and inductance.
- Use surface-mount instead of through-hole components for better high-frequency performance.
- Use a PC board with at least two layers; it should be as free from voids as possible.
- Keep signal lines as short and as straight as possible. Do not make 90° turns; round all corners.

MAX4412/MAX4413

## Low-Cost, Low-Power, Ultra-Small, 3V/5V, 500MHz Single-Supply Op Amps with Rail-to-Rail Outputs

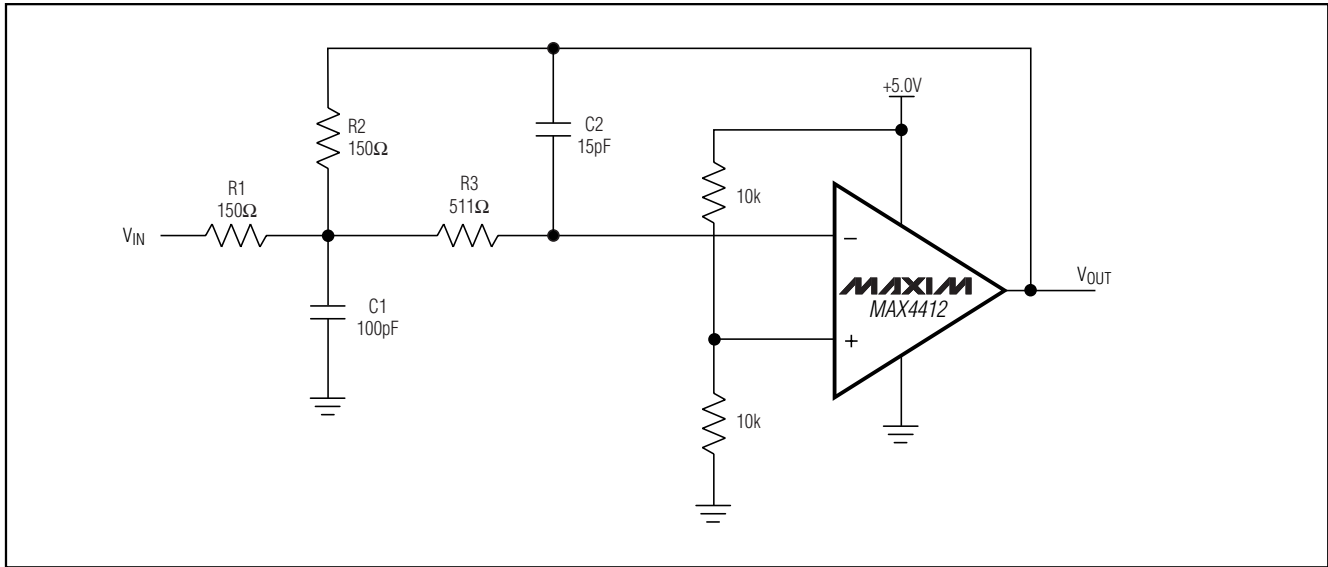

Figure 4. Multiple-Feedback Lowpass Filter

### Chip Information

MAX4412 TRANSISTOR COUNT: 99  
 MAX4413 TRANSISTOR COUNT: 192  
 PROCESS: Bipolar

# Low-Cost, Low-Power, Ultra-Small, 3V/5V, 500MHz Single-Supply Op Amps with Rail-to-Rail Outputs

## Package Information

**MAX4412/MAX4413**

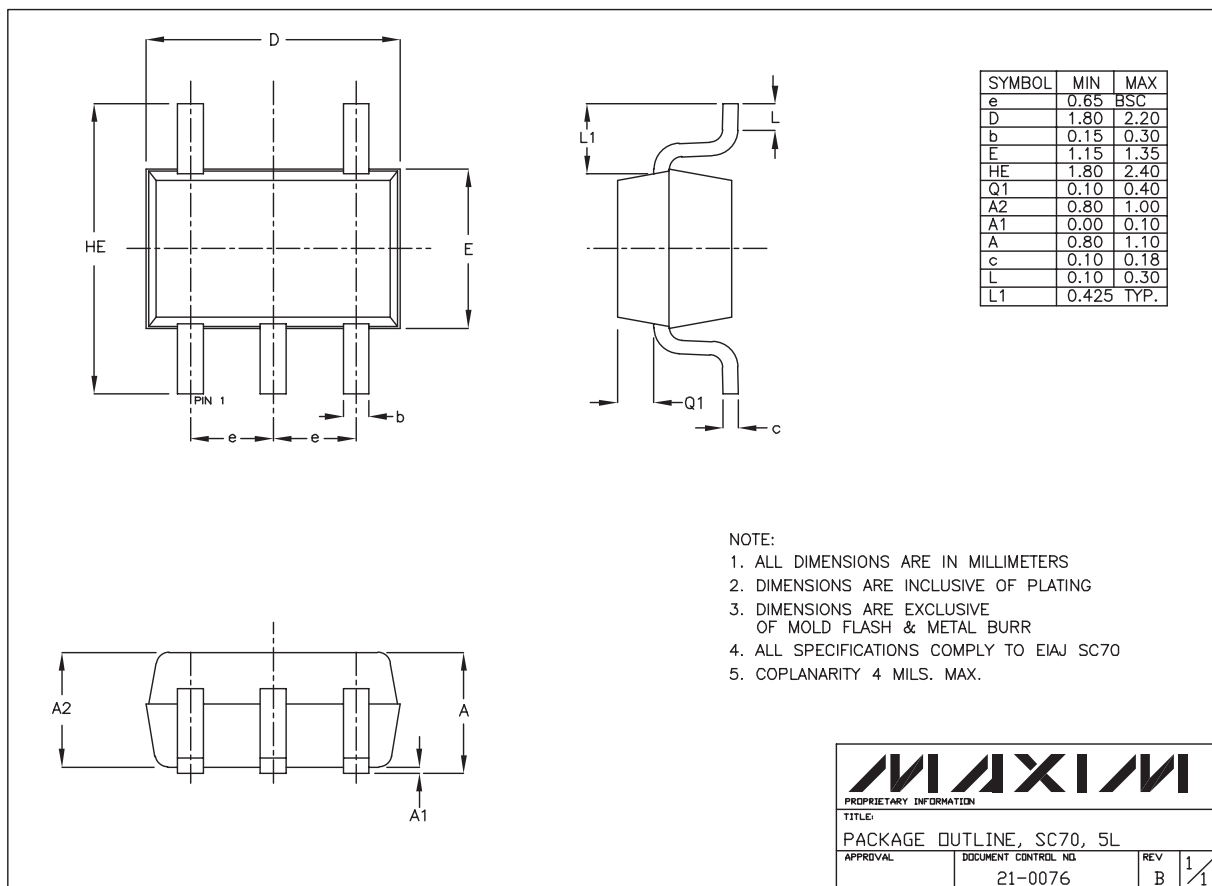

SC70, 5LEPS

# Low-Cost, Low-Power, Ultra-Small, 3V/5V, 500MHz Single-Supply Op Amps with Rail-to-Rail Outputs

## Package Information (continued)

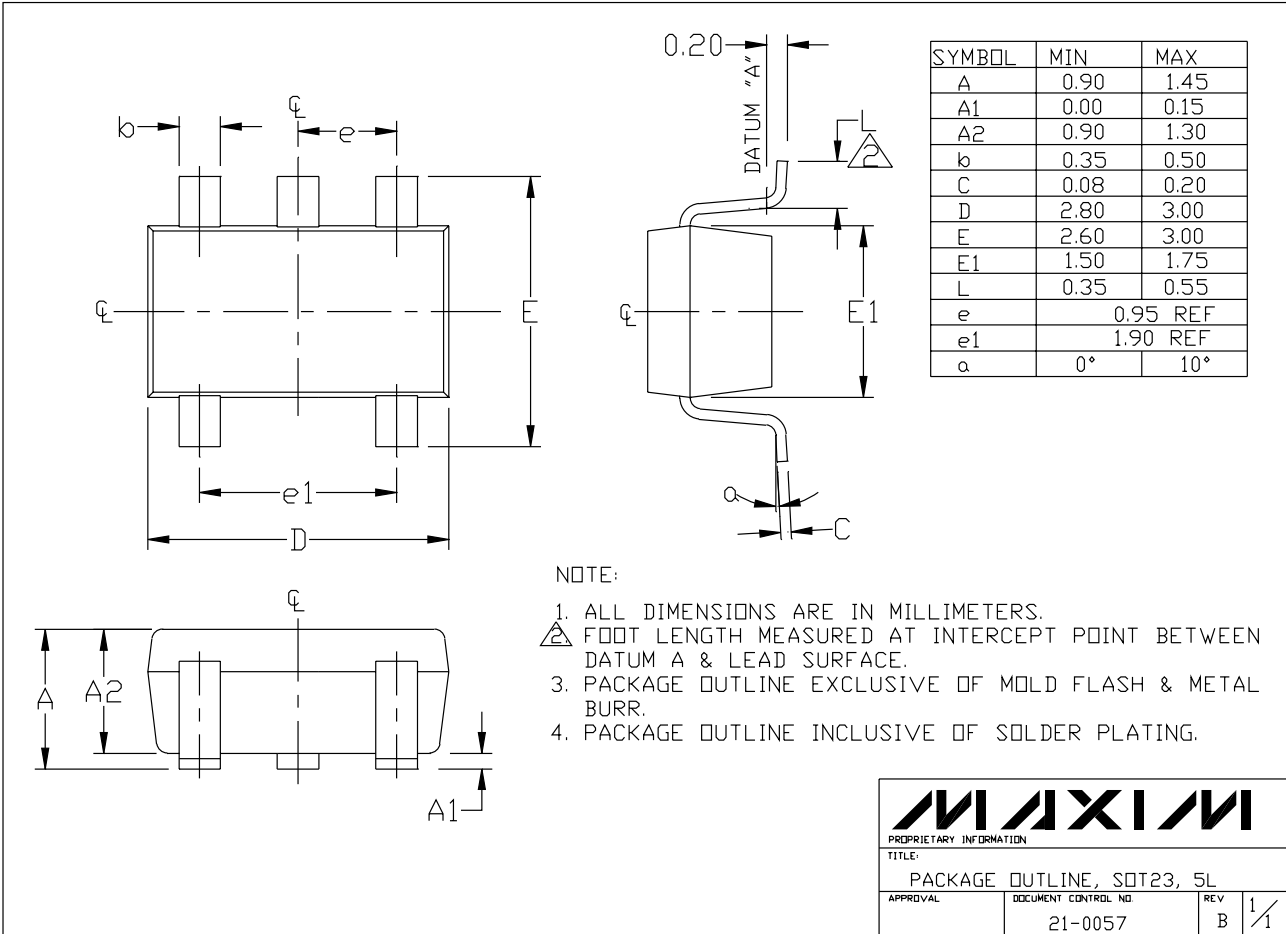

SOT23-5L

# Low-Cost, Low-Power, Ultra-Small, 3V/5V, 500MHz Single-Supply Op Amps with Rail-to-Rail Outputs

## Package Information (continued)

**MAX4412/MAX4413**

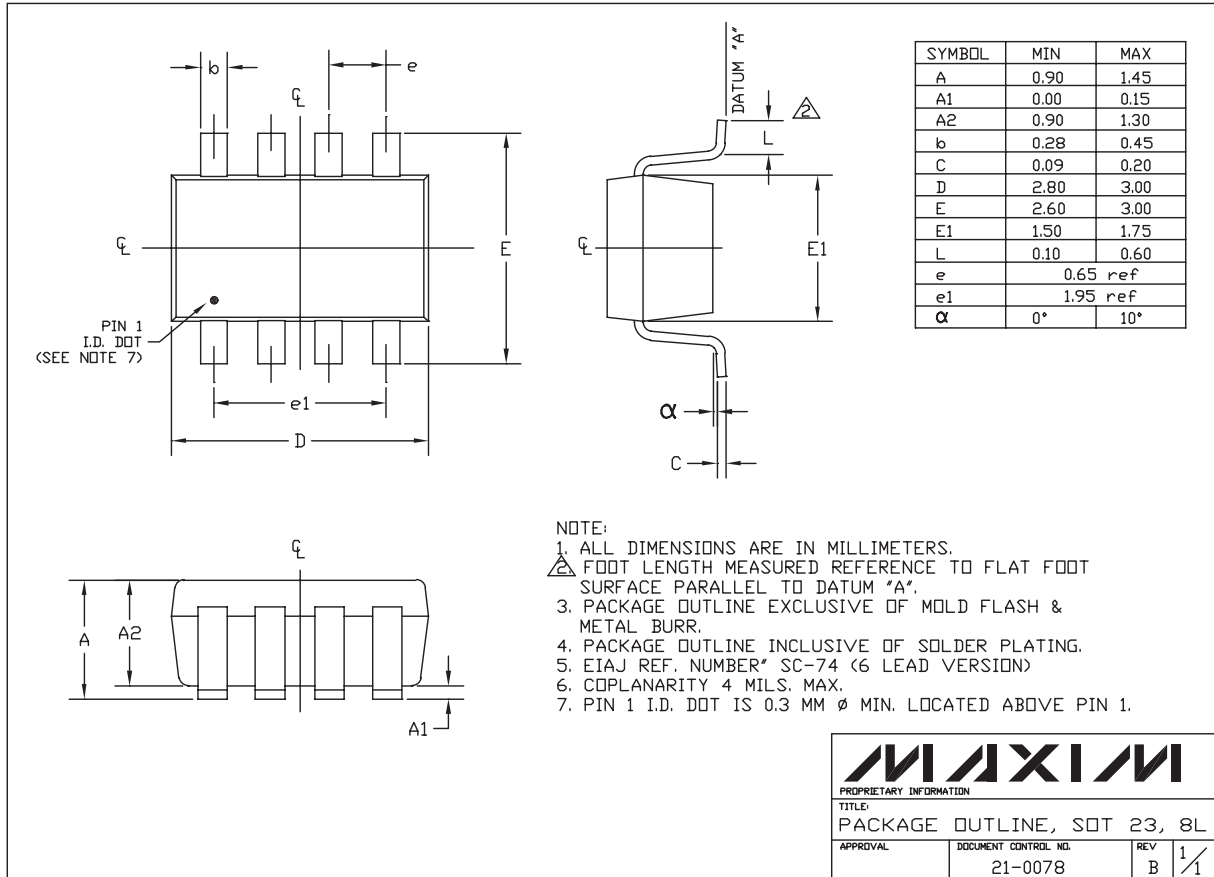

SOT23-8LEPS

**MAXIM**  
 PROPRIETARY INFORMATION  
 TITLE:  
 PACKAGE OUTLINE, SOT 23, 8L  
 APPROVAL: \_\_\_\_\_ DOCUMENT CONTROL NO. 21-0078 REV B 1/1

Maxim cannot assume responsibility for use of any circuitry other than circuitry entirely embodied in a Maxim product. No circuit patent licenses are implied. Maxim reserves the right to change the circuitry and specifications without notice at any time.

Maxim Integrated Products, 120 San Gabriel Drive, Sunnyvale, CA 94086 408-737-7600 \_\_\_\_\_ 15