

- Generation V Technology
- Ultra Low On-Resistance
- N-Channel MOSFET
- SOT-23 Footprint
- Low Profile (<1.1mm)
- Available in Tape and Reel
- Fast Switching

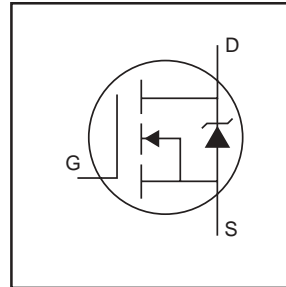

$$V_{DSS} = 20V$$

$$R_{DS(on)} = 0.25\Omega$$

Description

Fifth Generation HEXFETs from International Rectifier utilize advanced processing techniques to achieve extremely low on-resistance per silicon area. This benefit, combined with the fast switching speed and ruggedized device design that HEXFET Power MOSFETs are well known for, provides the designer with an extremely efficient and reliable device for use in a wide variety of applications.

A customized leadframe has been incorporated into the standard SOT-23 package to produce a HEXFET Power MOSFET with the industry's smallest footprint. This package, dubbed the Micro3, is ideal for applications where printed circuit board space is at a premium. The low profile (<1.1mm) of the Micro3 allows it to fit easily into extremely thin application environments such as portable electronics and PCMCIA cards.

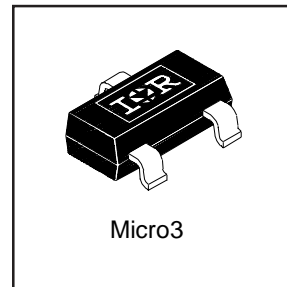

Micro3

Absolute Maximum Ratings

	Parameter	Max.	Units
$I_D @ T_A = 25^\circ C$	Continuous Drain Current, $V_{GS} @ 4.5V$	1.2	A
$I_D @ T_A = 70^\circ C$	Continuous Drain Current, $V_{GS} @ 4.5V$	0.95	
I_{DM}	Pulsed Drain Current ①	7.4	
$P_D @ T_A = 25^\circ C$	Power Dissipation	540	mW
	Linear Derating Factor	4.3	mW/°C
V_{GS}	Gate-to-Source Voltage	± 12	V
dv/dt	Peak Diode Recovery dv/dt ②	5.0	V/ns
T_J, T_{STG}	Junction and Storage Temperature Range	-55 to + 150	°C

Thermal Resistance

	Parameter	Typ.	Max.	Units
$R_{\theta JA}$	Maximum Junction-to-Ambient ④	—	230	°C/W

Electrical Characteristics @ $T_J = 25^\circ\text{C}$ (unless otherwise specified)

	Parameter	Min.	Typ.	Max.	Units	Conditions
$V_{(BR)DSS}$	Drain-to-Source Breakdown Voltage	20	—	—	V	$V_{GS} = 0V, I_D = 250\mu A$
$\Delta V_{(BR)DSS}/\Delta T_J$	Breakdown Voltage Temp. Coefficient	—	0.024	—	V/ $^\circ\text{C}$	Reference to $25^\circ\text{C}, I_D = 1mA$
$R_{DS(on)}$	Static Drain-to-Source On-Resistance	—	—	0.25	Ω	$V_{GS} = 4.5V, I_D = 0.93A$ ②
		—	—	0.35		$V_{GS} = 2.7V, I_D = 0.47A$ ③
$V_{GS(th)}$	Gate Threshold Voltage	0.70	—	—	V	$V_{DS} = V_{GS}, I_D = 250\mu A$
g_{fs}	Forward Transconductance	1.3	—	—	S	$V_{DS} = 10V, I_D = 0.47A$
I_{DSS}	Drain-to-Source Leakage Current	—	—	1.0	μA	$V_{DS} = 16V, V_{GS} = 0V$
		—	—	25		$V_{DS} = 16V, V_{GS} = 0V, T_J = 125^\circ\text{C}$
I_{GSS}	Gate-to-Source Forward Leakage	—	—	-100	nA	$V_{GS} = -12V$
	Gate-to-Source Reverse Leakage	—	—	100		$V_{GS} = 12V$
Q_g	Total Gate Charge	—	2.6	3.9	nC	$I_D = 0.93A$
Q_{gs}	Gate-to-Source Charge	—	0.41	0.62		$V_{DS} = 16V$
Q_{gd}	Gate-to-Drain ("Miller") Charge	—	1.1	1.7		$V_{GS} = 4.5V$, See Fig. 6 and 9 ③
$t_{d(on)}$	Turn-On Delay Time	—	2.5	—	ns	$V_{DD} = 10V$
t_r	Rise Time	—	9.5	—		$I_D = 0.93A$
$t_{d(off)}$	Turn-Off Delay Time	—	9.7	—		$R_G = 6.2\Omega$
t_f	Fall Time	—	4.8	—		$R_D = 11\Omega$, See Fig. 10 ③
C_{iss}	Input Capacitance	—	110	—	pF	$V_{GS} = 0V$
C_{oss}	Output Capacitance	—	51	—		$V_{DS} = 15V$
C_{rss}	Reverse Transfer Capacitance	—	25	—		$f = 1.0MHz$, See Fig. 5

Source-Drain Ratings and Characteristics

	Parameter	Min.	Typ.	Max.	Units	Conditions
I_S	Continuous Source Current (Body Diode)	—	—	0.54	A	MOSFET symbol showing the integral reverse p-n junction diode.
I_{SM}	Pulsed Source Current (Body Diode) ①	—	—	7.4		
V_{SD}	Diode Forward Voltage	—	—	1.2	V	$T_J = 25^\circ\text{C}, I_S = 0.93A, V_{GS} = 0V$ ③
t_{rr}	Reverse Recovery Time	—	25	38	ns	$T_J = 25^\circ\text{C}, I_F = 0.93A$
Q_{rr}	Reverse Recovery Charge	—	16	24	nC	$di/dt = 100A/\mu s$ ③

Notes:

- ① Repetitive rating; pulse width limited by max. junction temperature. (See fig. 11)
- ② $I_{SD} \leq 0.93A, di/dt \leq 90A/\mu s, V_{DD} \leq V_{(BR)DSS}, T_J \leq 150^\circ\text{C}$
- ③ Pulse width $\leq 300\mu s$; duty cycle $\leq 2\%$.
- ④ Surface mounted on FR-4 board, $t \leq 5sec.$

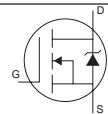

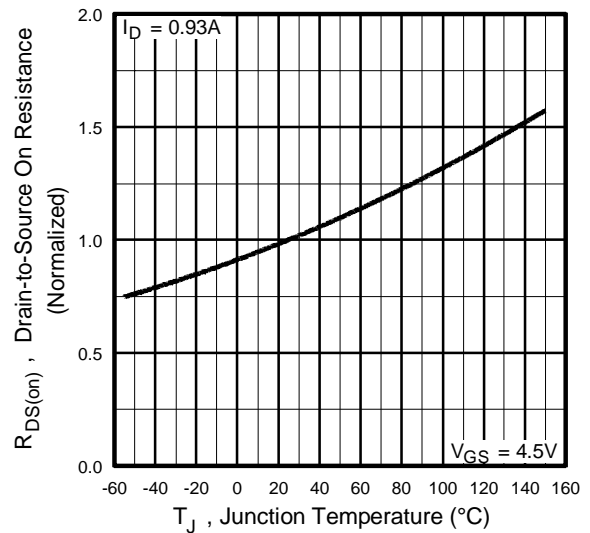
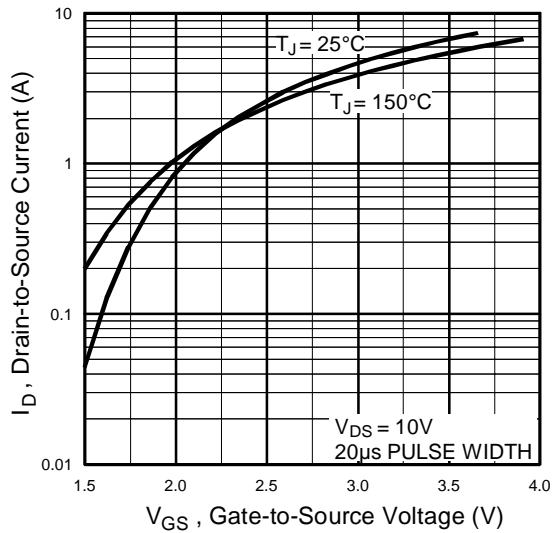
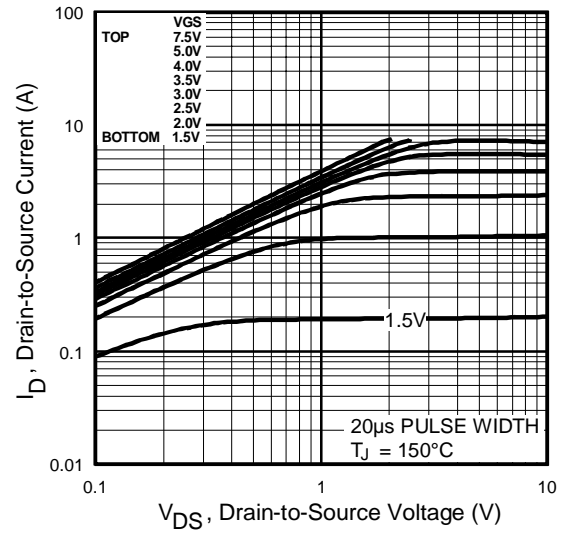
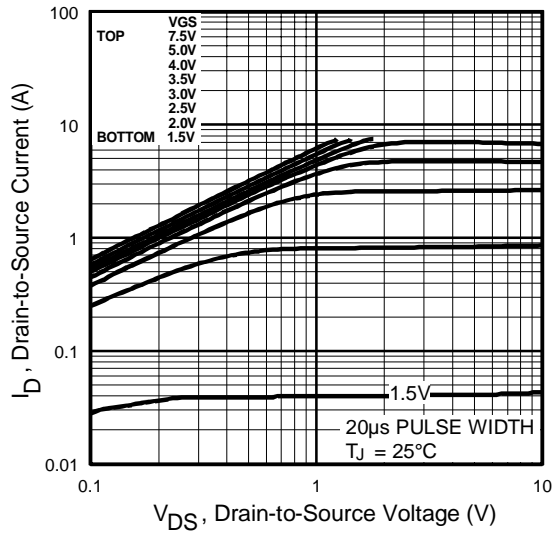

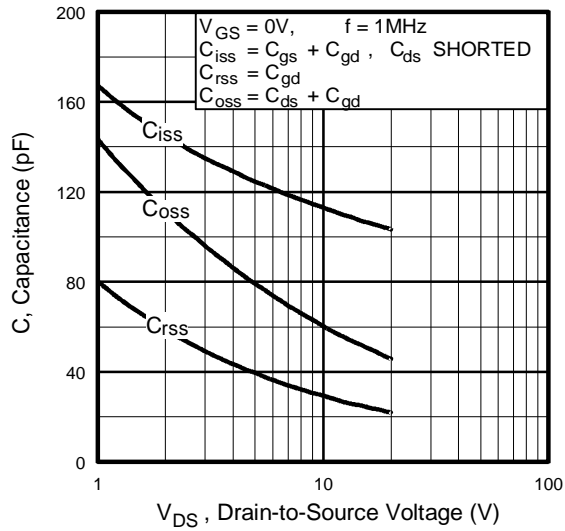

Fig 5. Typical Capacitance Vs. Drain-to-Source Voltage

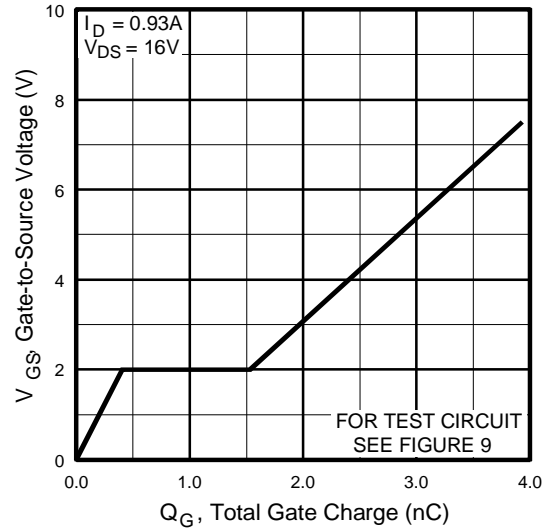

Fig 6. Typical Gate Charge Vs. Gate-to-Source Voltage

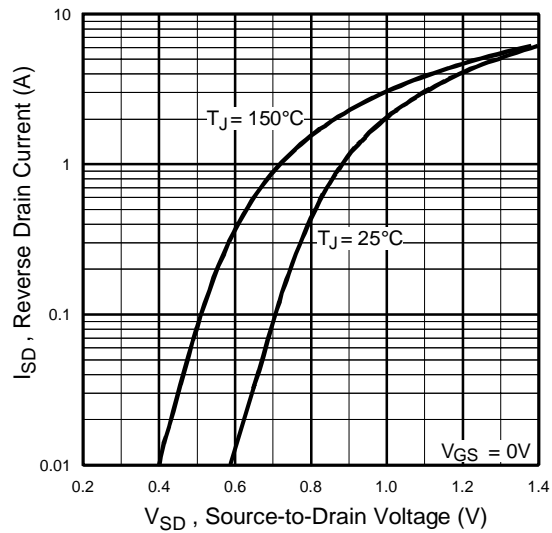

Fig 7. Typical Source-Drain Diode Forward Voltage

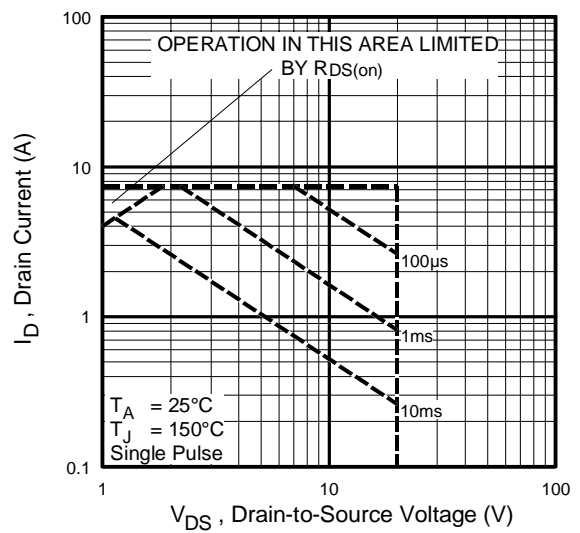

Fig 8. Maximum Safe Operating Area

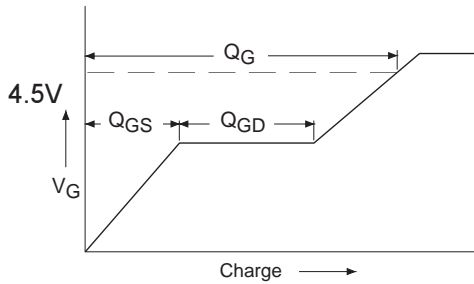

Fig 9a. Basic Gate Charge Waveform

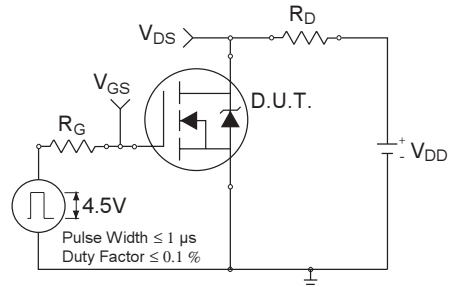

Fig 10a. Switching Time Test Circuit

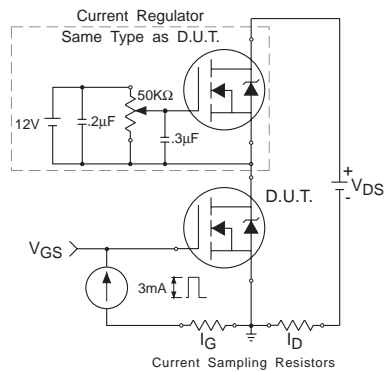

Fig 9b. Gate Charge Test Circuit

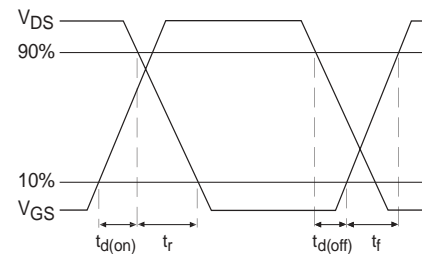

Fig 10b. Switching Time Waveforms

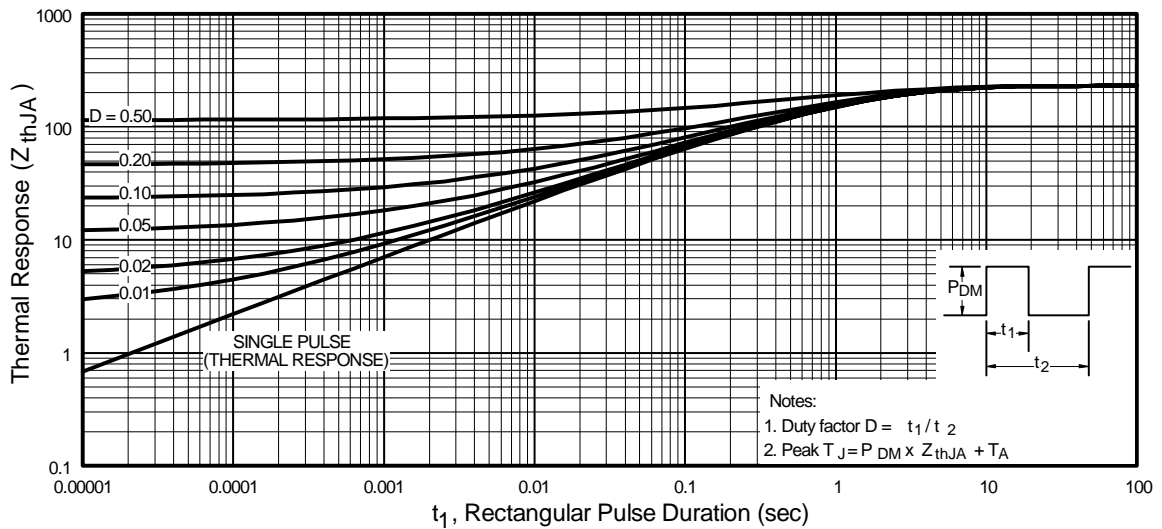

Fig 11. Maximum Effective Transient Thermal Impedance, Junction-to-Ambient

Peak Diode Recovery dv/dt Test Circuit

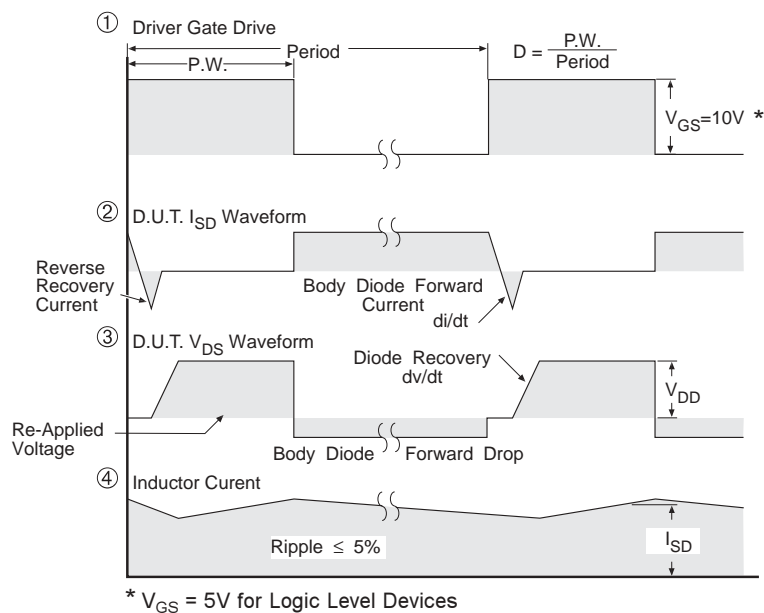
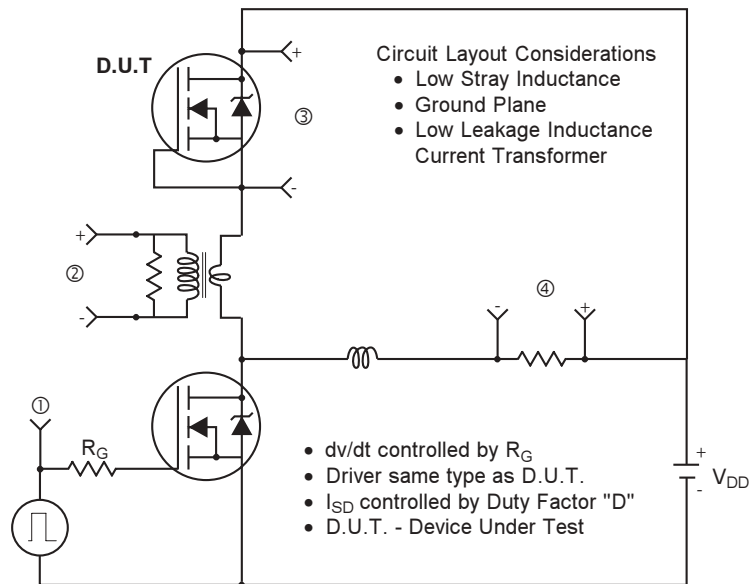
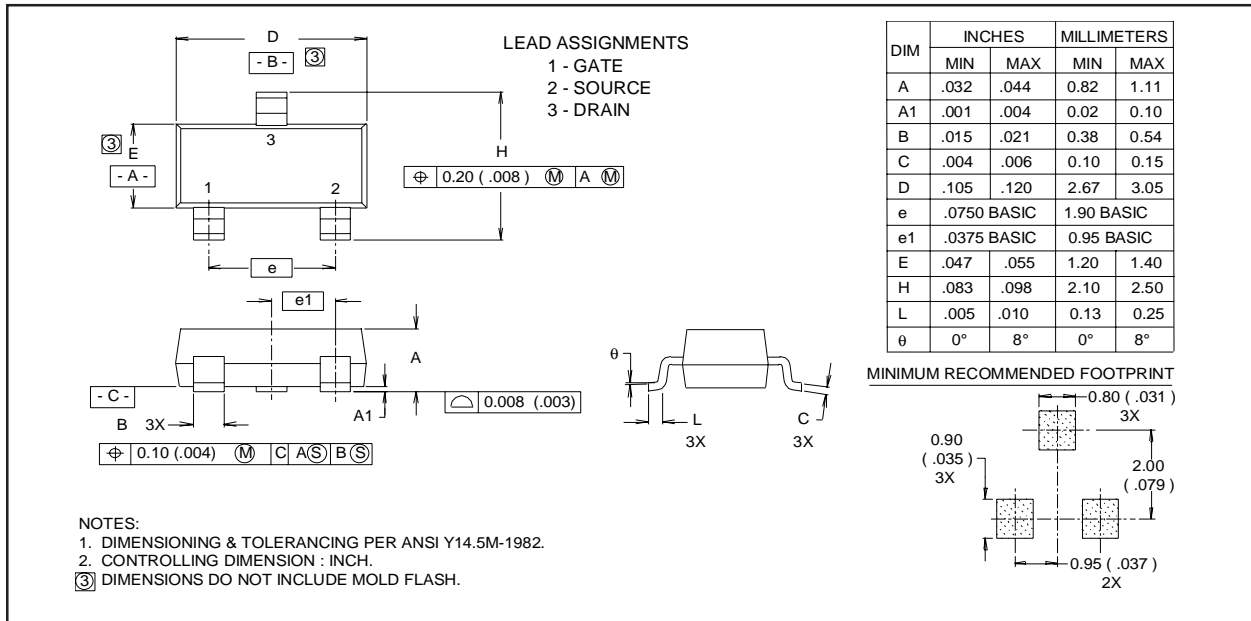

Fig 12. For N-Channel HEXFETS

Package Outline

Micro3 (SOT-23 / TO-236AB)

Dimensions are shown in millimeters (inches)



Part Marking Information

Micro3 (SOT-23 / TO-236AB)

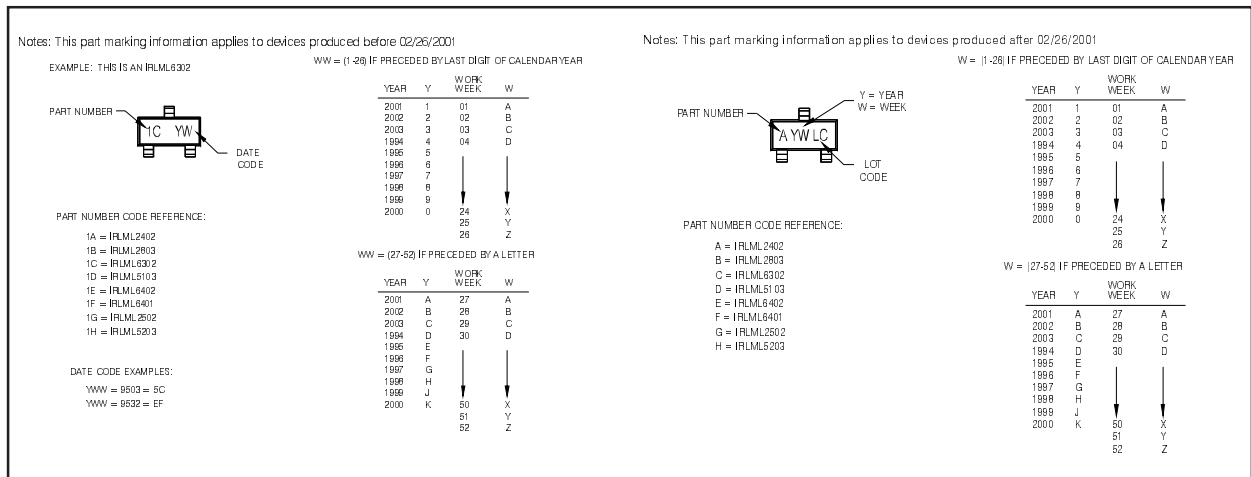

IRLML2402

International
IR Rectifier

Tape & Reel Information

Micro3 (SOT-23 / TO-236AB)

Dimensions are shown in millimeters (inches)

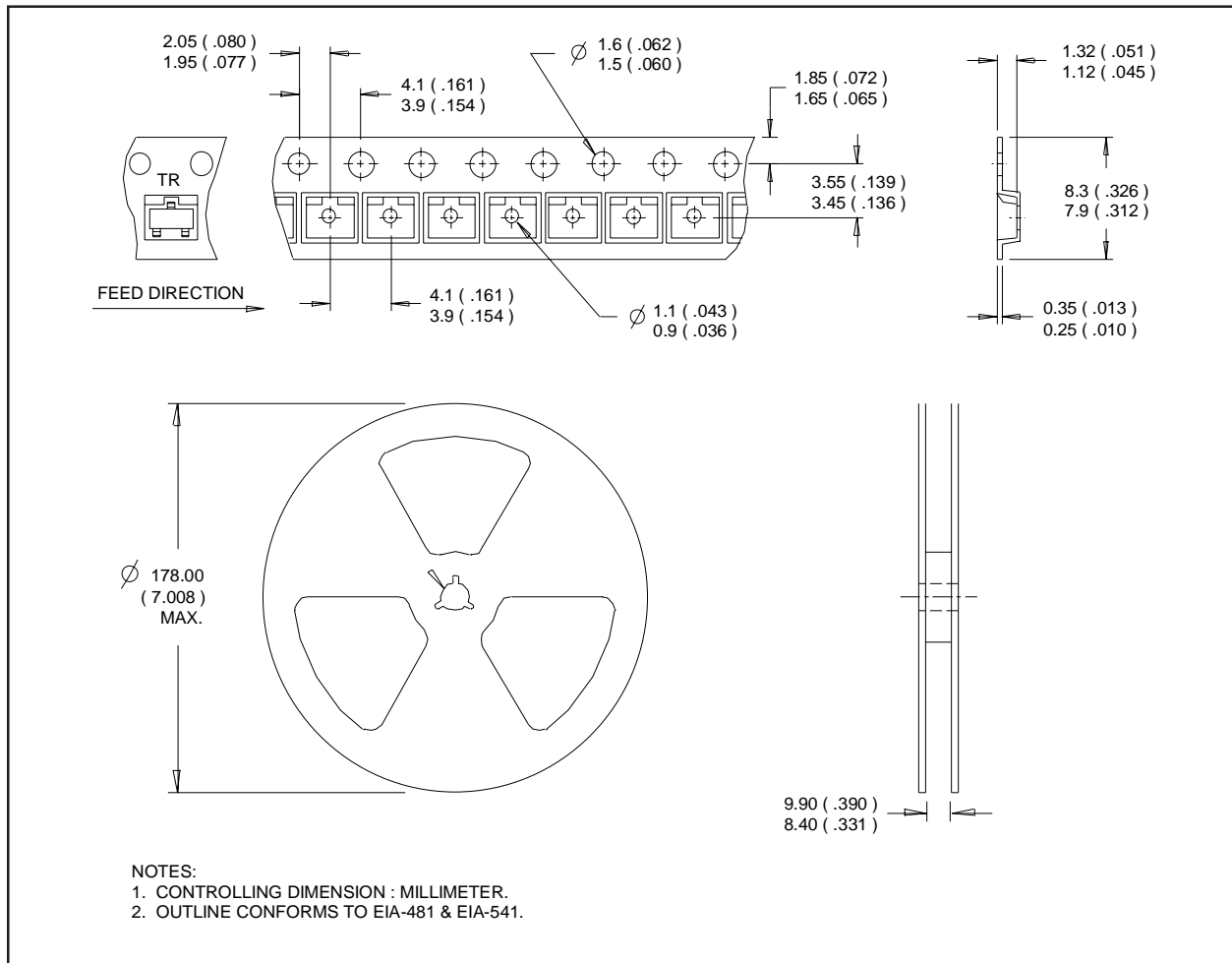

International
IR Rectifier

IR WORLD HEADQUARTERS: 233 Kansas St., El Segundo, California 90245, USA Tel: (310) 252-7105

TAC Fax: (310) 252-7903

Visit us at www.irf.com for sales contact information. 01/03