

International
IR Rectifier
 INSULATED GATE BIPOLAR TRANSISTOR

PD - 94545C

IRGB8B60K
IRGS8B60K
IRGSL8B60K

Features

- Low VCE (on) Non Punch Through IGBT Technology.
- 10µs Short Circuit Capability.
- Square RBSOA.
- Positive VCE (on) Temperature Coefficient.

Benefits

- Benchmark Efficiency for Motor Control.
- Rugged Transient Performance.
- Low EMI.
- Excellent Current Sharing in Parallel Operation.

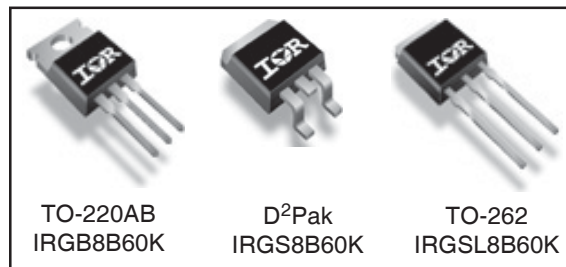
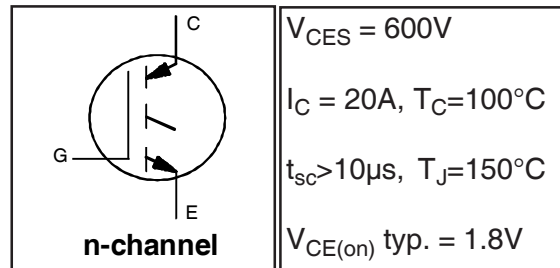

Absolute Maximum Ratings

	Parameter	Max.	Units
V_{CES}	Collector-to-Emitter Voltage	600	V
$I_C @ T_C = 25^\circ C$	Continuous Collector Current	28	A
$I_C @ T_C = 100^\circ C$	Continuous Collector Current	19	
I_{CM}	Pulse Collector Current (Ref.Fig.C.T.5)	56	
I_{LM}	Clamped Inductive Load current ①	56	
V_{GE}	Gate-to-Emitter Voltage	±20	
$P_D @ T_C = 25^\circ C$	Maximum Power Dissipation	167	W
$P_D @ T_C = 100^\circ C$	Maximum Power Dissipation	83	
T_J	Operating Junction and	-55 to +175	°C
T_{STG}	Storage Temperature Range		
	Storage Temperature Range, for 10 sec.		

Thermal / Mechanical Characteristics

	Parameter	Min.	Typ.	Max.	Units
$R_{\theta JC}$	Junction-to-Case- IGBT	—	—	0.90	°C/W
$R_{\theta CS}$	Case-to-Sink, flat, greased surface	—	0.50	—	
$R_{\theta JA}$	Junction-to-Ambient, typical socket mount ②	—	—	62	
$R_{\theta JA}$	Junction-to-Ambient (PCB Mount, Steady State) ③	—	—	40	
	Weight	—	1.44	—	g

www.irf.com

1

10/16/03

Electrical Characteristics @ $T_J = 25^\circ\text{C}$ (unless otherwise specified)

	Parameter	Min.	Typ.	Max.	Units	Conditions	Ref.Fig.
$V_{(BR)CES}$	Collector-to-Emitter Breakdown Voltage	600	—	—	V	$V_{GE} = 0V, I_C = 500\mu A$	
$\Delta V_{(BR)CES}/\Delta T_J$	Temperature Coeff. of Breakdown Voltage	—	0.57	—	V/°C	$V_{GE} = 0V, I_C = 1mA (25^\circ\text{C}-150^\circ\text{C})$	
$V_{CE(on)}$	Collector-to-Emitter Voltage	—	1.8	2.2	V	$I_C = 8.0A, V_{GE} = 15V, T_J = 25^\circ\text{C}$	5,6,7
		—	2.2	2.5		$I_C = 8.0A, V_{GE} = 15V, T_J = 150^\circ\text{C}$	8,9,10
		—	2.3	2.6		$I_C = 8.0A, V_{GE} = 15V, T_J = 175^\circ\text{C}$	
$V_{GE(th)}$	Gate Threshold Voltage	3.5	4.5	5.5		$V_{CE} = V_{GE}, I_C = 250\mu A$	8,9,10,
$\Delta V_{GE(th)}/\Delta T_J$	Threshold Voltage temp. coefficient	—	-9.5	—	mV/°C	$V_{CE} = V_{GE}, I_C = 1mA (25^\circ\text{C}-125^\circ\text{C})$	11
g_{fe}	Forward Transconductance	—	3.7	—	S	$V_{CE} = 50V, I_C = 8.0A, PW = 80\mu s$	
I_{CES}	Zero Gate Voltage Collector Current	—	1.0	150	μA	$V_{GE} = 0V, V_{CE} = 600V$	
		—	200	500		$V_{GE} = 0V, V_{CE} = 600V, T_J = 150^\circ\text{C}$	
		—	800	1320		$V_{GE} = 0V, V_{CE} = 600V, T_J = 175^\circ\text{C}$	
I_{GES}	Gate-to-Emitter Leakage Current	—	—	± 100	nA	$V_{GE} = \pm 20V$	

Switching Characteristics @ $T_J = 25^\circ\text{C}$ (unless otherwise specified)

	Parameter	Min.	Typ.	Max.	Units	Conditions	Ref.Fig.
Q_g	Total Gate Charge (turn-on)	—	29	—	nC	$I_C = 8.0A$	17
Q_{ge}	Gate-to-Emitter Charge (turn-on)	—	3.7	—		$V_{CC} = 480V$	CT1
Q_{gc}	Gate-to-Collector Charge (turn-on)	—	14	—		$V_{GE} = 15V$	
E_{on}	Turn-On Switching Loss	—	160	268	μJ	$I_C = 8.0A, V_{CC} = 400V$	CT4
E_{off}	Turn-Off Switching Loss	—	160	268		$V_{GE} = 15V, R_G = 50\Omega, L = 1.1mH$	
E_{tot}	Total Switching Loss	—	320	433		$T_J = 25^\circ\text{C} \text{ ④}$	
$t_{d(on)}$	Turn-On delay time	—	23	27	ns	$I_C = 8.0A, V_{CC} = 400V$	CT4
t_r	Rise time	—	22	26		$V_{GE} = 15V, R_G = 50\Omega, L = 1.1mH$	
$t_{d(off)}$	Turn-Off delay time	—	140	150		$T_J = 25^\circ\text{C}$	
t_f	Fall time	—	32	42			
E_{on}	Turn-On Switching Loss	—	220	330	μJ	$I_C = 8.0A, V_{CC} = 400V$	CT4
E_{off}	Turn-Off Switching Loss	—	270	381		$V_{GE} = 15V, R_G = 50\Omega, L = 1.1mH$	12,14
E_{tot}	Total Switching Loss	—	490	608		$T_J = 150^\circ\text{C} \text{ ④}$	WF1,WF2
$t_{d(on)}$	Turn-On delay time	—	22	27	ns	$I_C = 8.0A, V_{CC} = 400V$	13,15
t_r	Rise time	—	21	25		$V_{GE} = 15V, R_G = 50\Omega, L = 1.1mH$	CT4
$t_{d(off)}$	Turn-Off delay time	—	180	198		$T_J = 150^\circ\text{C}$	WF1
t_f	Fall time	—	40	56			WF2
C_{ies}	Input Capacitance	—	440	—	pF	$V_{GE} = 0V$	16
C_{oes}	Output Capacitance	—	38	—		$V_{CC} = 30V$	
C_{res}	Reverse Transfer Capacitance	—	16	—		$f = 1.0MHz$	
RBSOA	Reverse Bias Safe Operating Area	FULL SQUARE				$T_J = 150^\circ\text{C}, I_C = 34A, V_p = 600V$ $V_{CC}=500V, V_{GE} = +15V \text{ to } 0V, R_G = 50\Omega$	4 CT2
SCSOA	Short Circuit Safe Operating Area	10	—	—	μs	$T_J = 150^\circ\text{C}, V_p = 600V, R_G = 100\Omega$ $V_{CC}=360V, V_{GE} = +15V \text{ to } 0V$	CT3 WF3

Notes ① to ④ are on page 13.

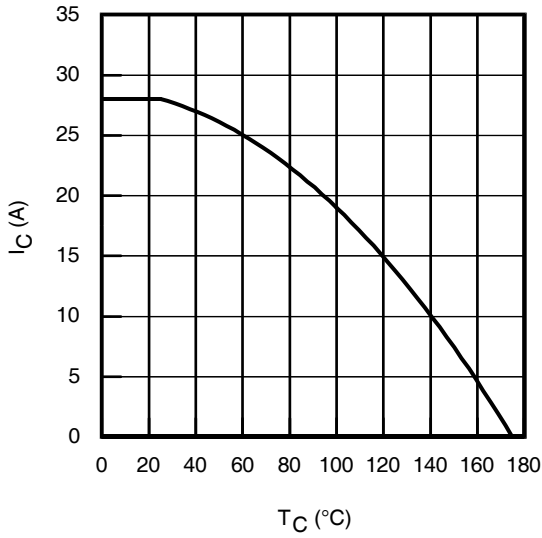

Fig. 1 - Maximum DC Collector Current vs. Case Temperature

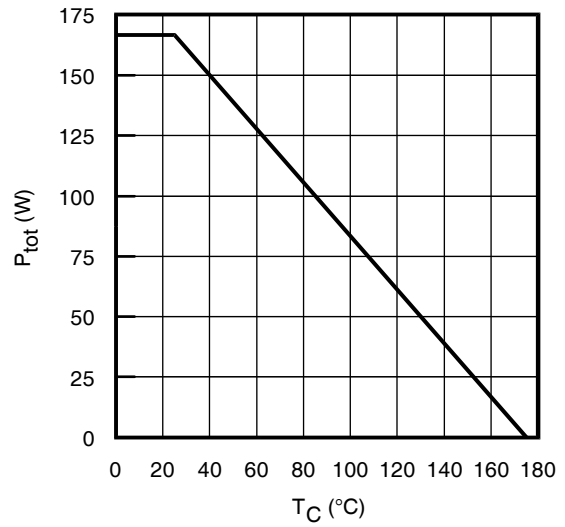

Fig. 2 - Power Dissipation vs. Case Temperature

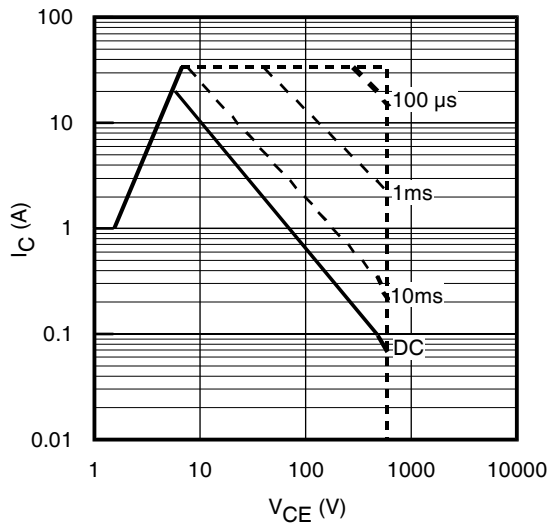

Fig. 3 - Forward SOA
 $T_C = 25^\circ\text{C}$; $T_J \leq 150^\circ\text{C}$

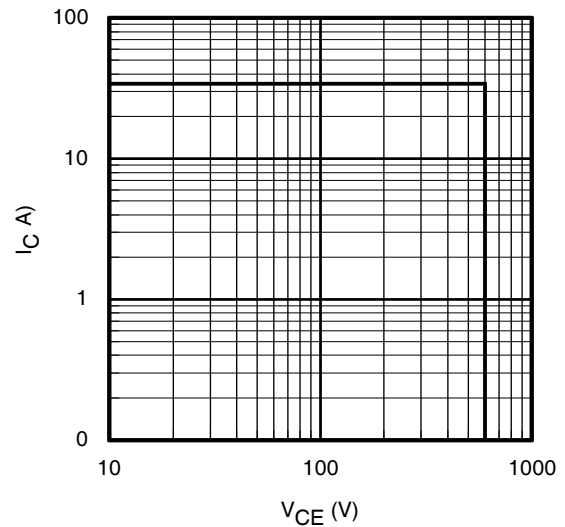

Fig. 4 - Reverse Bias SOA
 $T_J = 150^\circ\text{C}$; $V_{GE} = 15\text{V}$

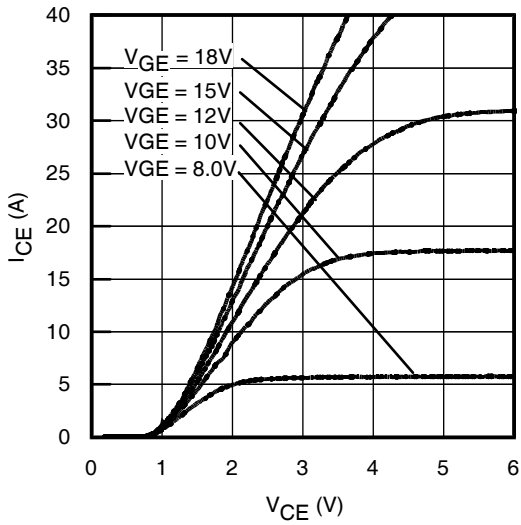

Fig. 5 - Typ. IGBT Output Characteristics
 $T_J = -40^{\circ}\text{C}$; $t_p = 80\mu\text{s}$

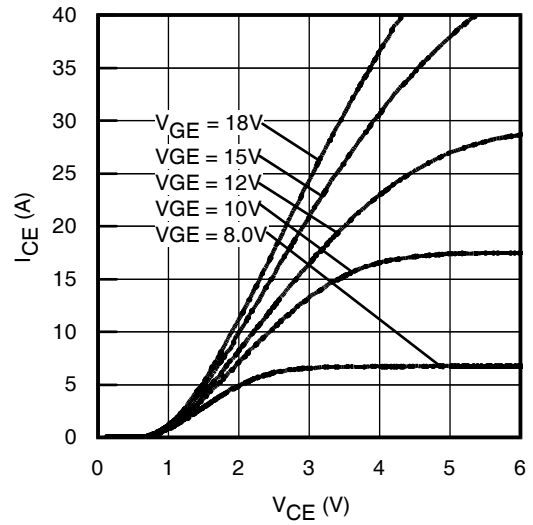

Fig. 6 - Typ. IGBT Output Characteristics
 $T_J = 25^{\circ}\text{C}$; $t_p = 80\mu\text{s}$

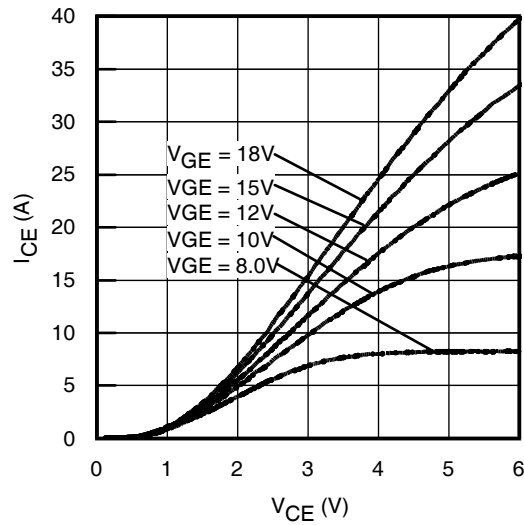

Fig. 7 - Typ. IGBT Output Characteristics
 $T_J = 150^{\circ}\text{C}$; $t_p = 80\mu\text{s}$

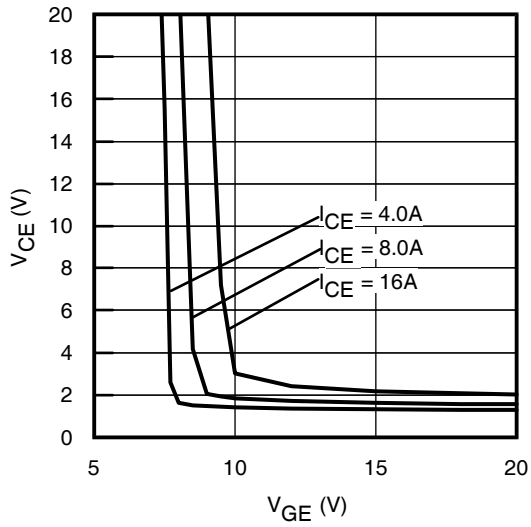

Fig. 8 - Typical V_{CE} vs. V_{GE}
 $T_J = -40^\circ\text{C}$

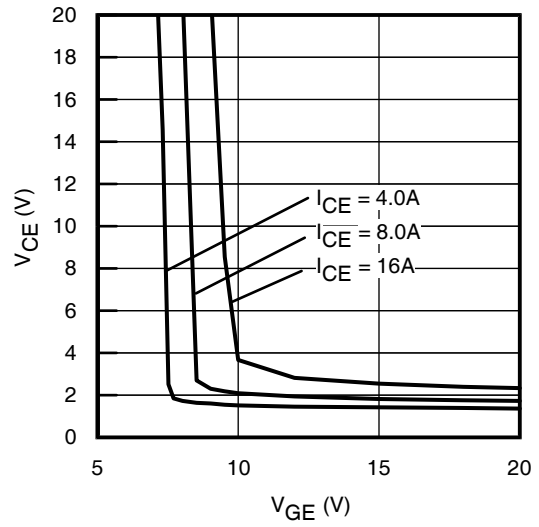

Fig. 9 - Typical V_{CE} vs. V_{GE}
 $T_J = 25^\circ\text{C}$

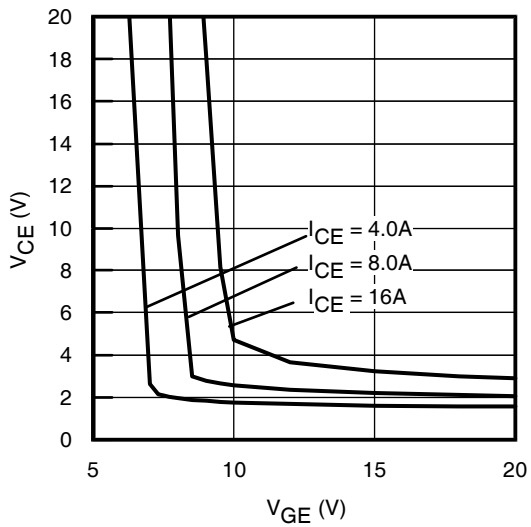

Fig. 10 - Typical V_{CE} vs. V_{GE}
 $T_J = 150^\circ\text{C}$

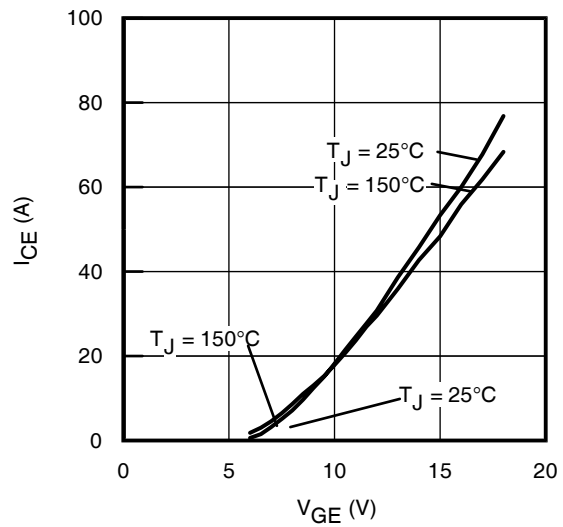

Fig. 11 - Typ. Transfer Characteristics
 $V_{CE} = 360\text{V}$; $t_p = 10\mu\text{s}$

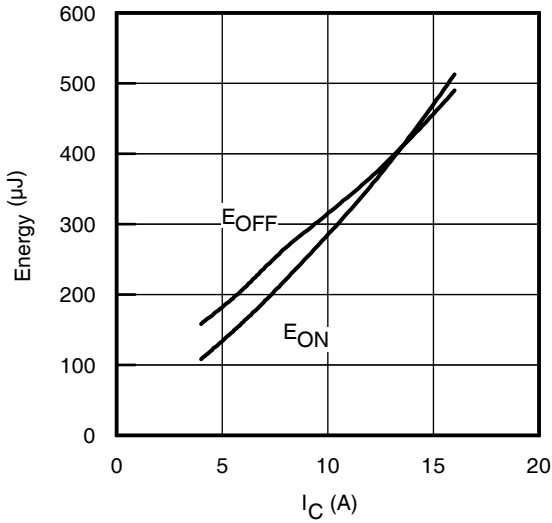

Fig. 12 - Typ. Energy Loss vs. I_C
 $T_J = 150^\circ\text{C}$; $L=1.1\text{mH}$; $V_{CE}= 400\text{V}$,
 $R_G= 50\Omega$; $V_{GE}= 15\text{V}$

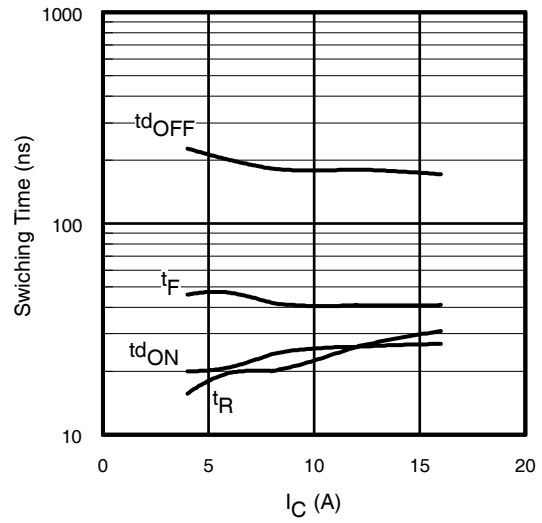

Fig. 13 - Typ. Switching Time vs. I_C
 $T_J = 150^\circ\text{C}$; $L=1.1\text{mH}$; $V_{CE}= 400\text{V}$
 $R_G= 50\Omega$; $V_{GE}= 15\text{V}$

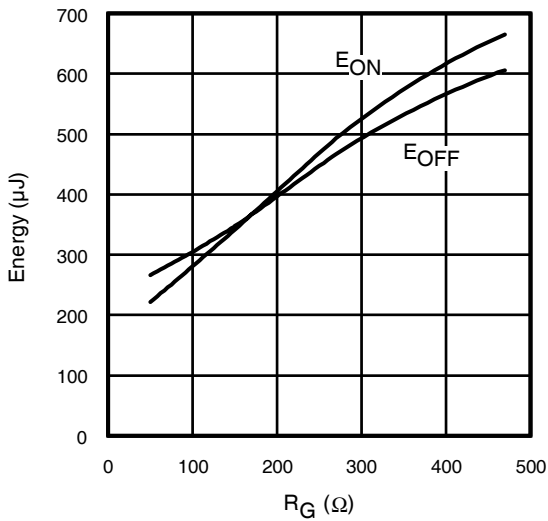

Fig. 14 - Typ. Energy Loss vs. R_G
 $T_J = 150^\circ\text{C}$; $L=1.1\text{mH}$; $V_{CE}= 400\text{V}$
 $I_{CE}= 8.0\text{A}$; $V_{GE}= 15\text{V}$

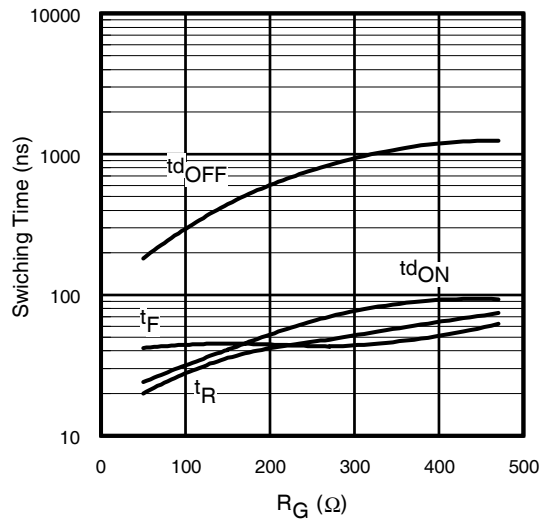

Fig. 15 - Typ. Switching Time vs. R_G
 $T_J = 150^\circ\text{C}$; $L=1.1\text{mH}$; $V_{CE}= 400\text{V}$
 $I_{CE}= 8.0\text{A}$; $V_{GE}= 15\text{V}$

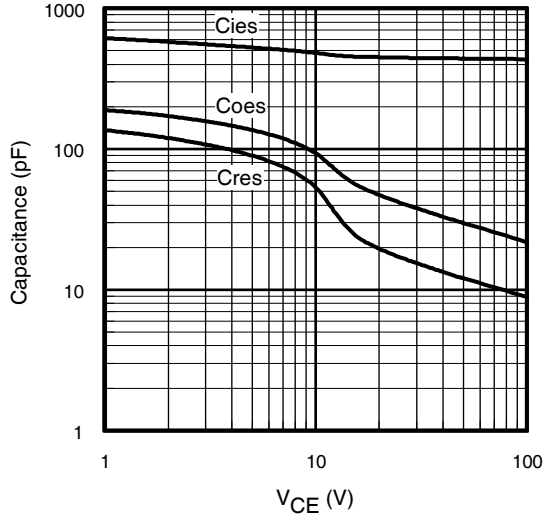

Fig. 16- Typ. Capacitance vs. V_{CE}
V_{GE} = 0V; f = 1MHz

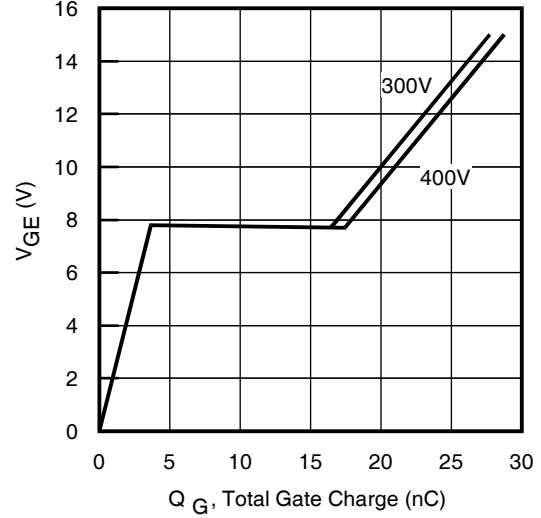

Fig. 17 - Typical Gate Charge vs. V_{GE}
I_{CE} = 8.0A; L = 600μH

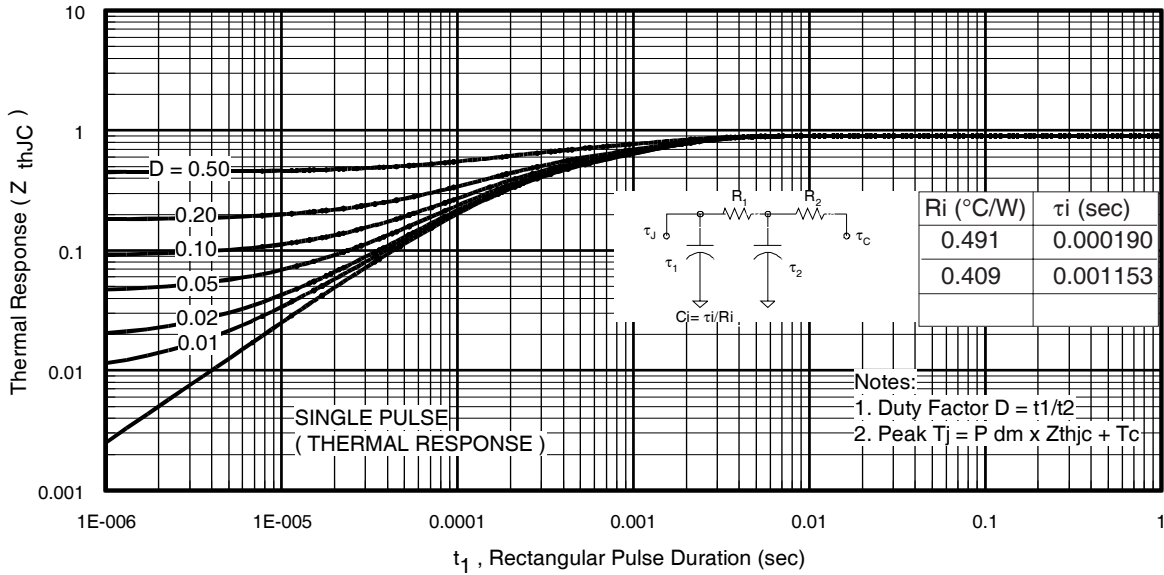

Fig 18. Maximum Transient Thermal Impedance, Junction-to-Case (IGBT)

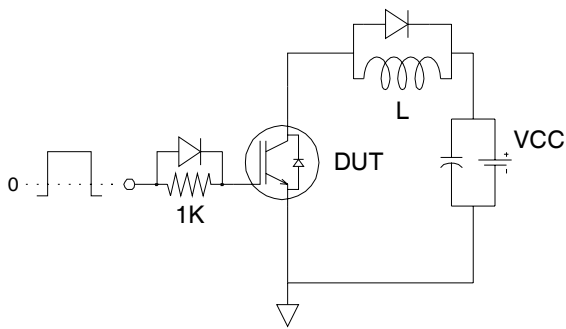

Fig.C.T.1 - Gate Charge Circuit (turn-off)

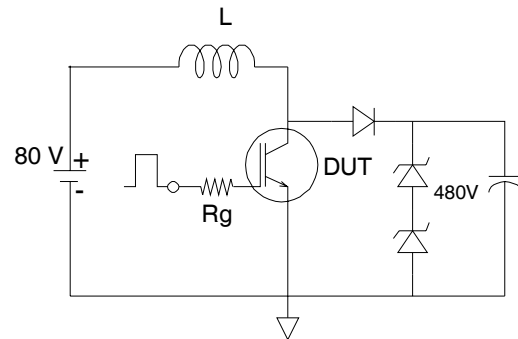

Fig.C.T.2 - RBSOA Circuit

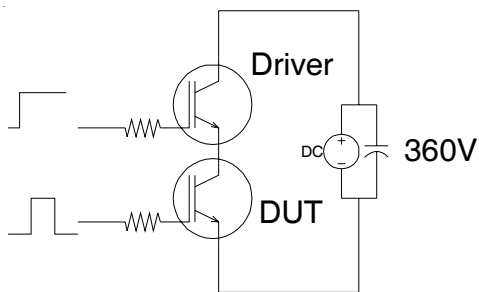

Fig.C.T.3 - S.C.SOA Circuit

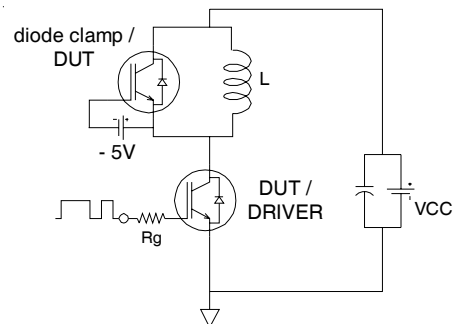

Fig.C.T.4 - Switching Loss Circuit

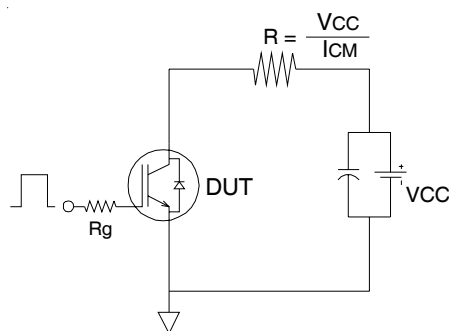

Fig.C.T.5 - Resistive Load Circuit

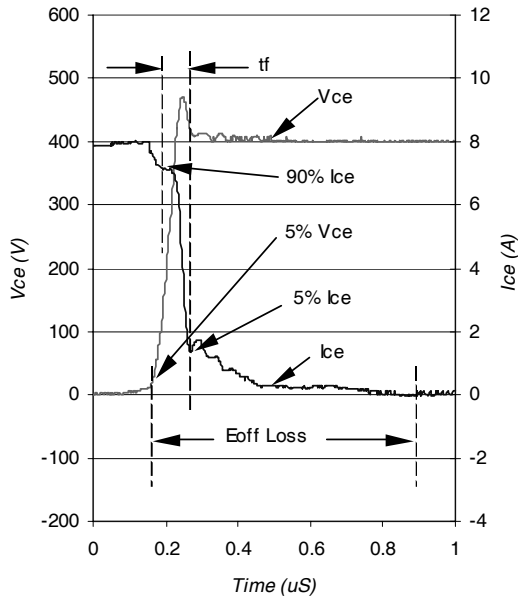

Fig. WF1- Typ. Turn-off Loss Waveform
 @ $T_J = 150^{\circ}\text{C}$ using Fig. CT.4

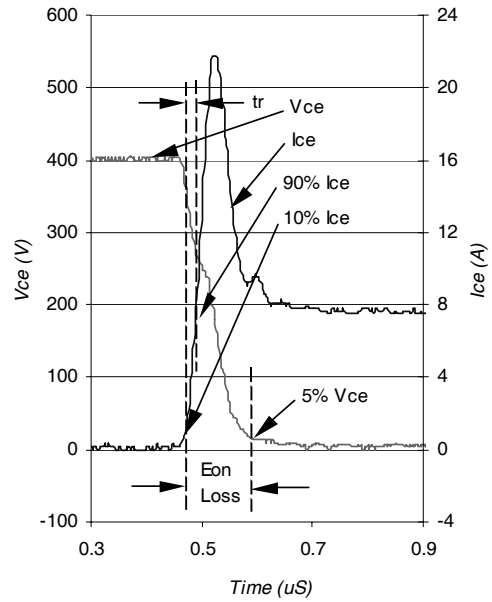

Fig. WF2- Typ. Turn-on Loss Waveform
 @ $T_J = 150^{\circ}\text{C}$ using Fig. CT.4

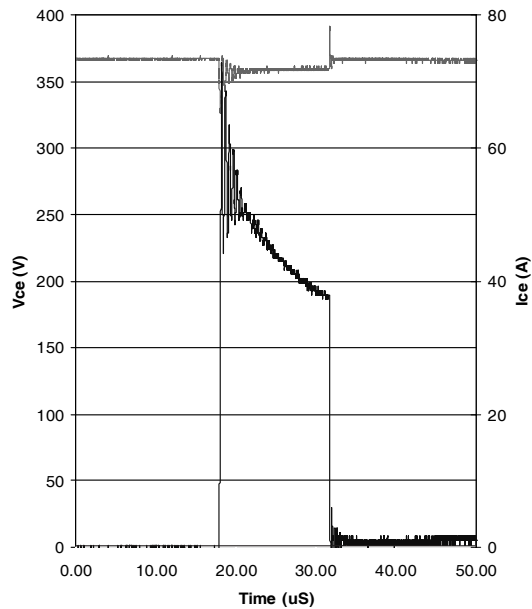

Fig. WF3- Typ. S.C Waveform
 @ $T_C = 150^{\circ}\text{C}$ using Fig. CT.3

IRGB/S/SL8B60K

TO-220AB Package Outline

Dimensions are shown in millimeters (inches)

International
IR Rectifier

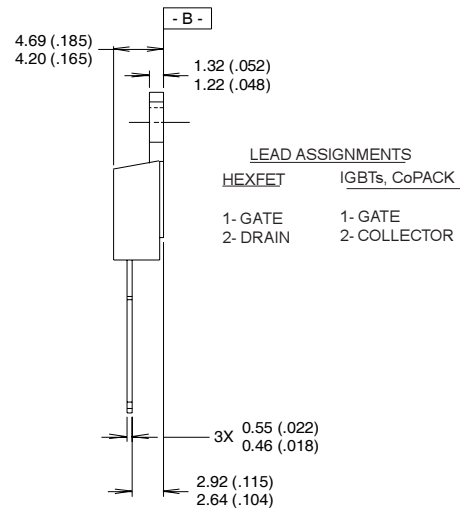
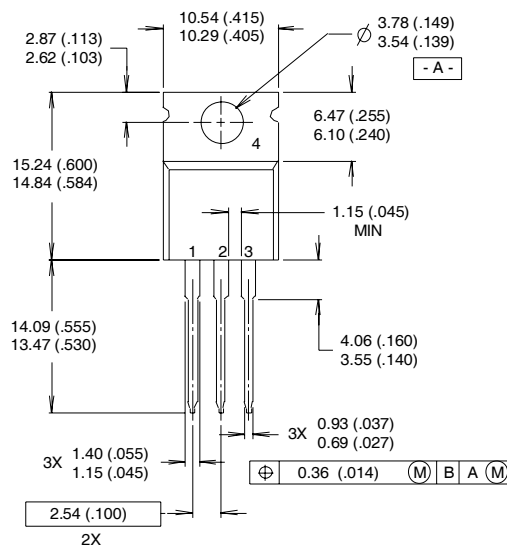

NOTES:

- 1 DIMENSIONING & TOLERANCING PER ANSI Y14.5M, 1982.
- 2 CONTROLLING DIMENSION : INCH
- 3 OUTLINE CONFORMS TO JEDEC OUTLINE TO-220AB.
- 4 HEATSINK & LEAD MEASUREMENTS DO NOT INCLUDE BURRS.

TO-220AB Part Marking Information

EXAMPLE: THIS IS AN IRF1010
 LOT CODE 1789
 ASSEMBLED ON WW 19, 1997
 IN THE ASSEMBLY LINE "C"

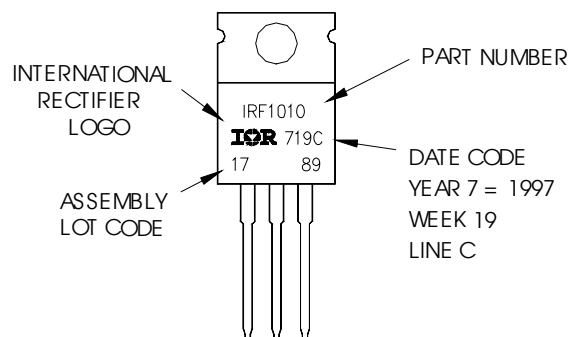

D²Pak Package Outline

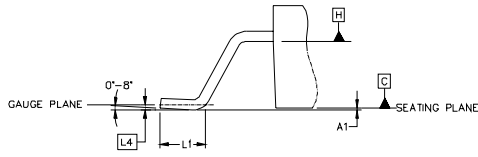

DETAIL "A"
ROTATED 90°
SCALE 8:1

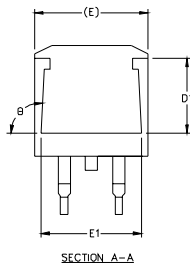

SECTION A-A

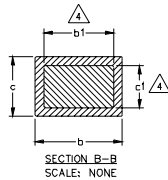

SECTION B-B
SCALE: NONE

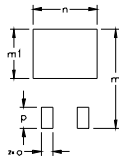

FOOT PRINT
SCALE 2:1

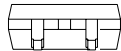
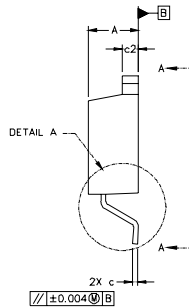
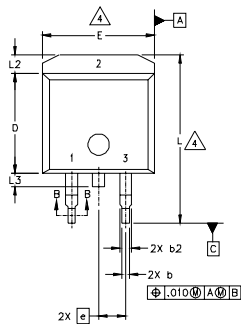

IRGB/S/SL8B60K

SYMBOL	DIMENSIONS				NOTES
	MILLIMETERS		INCHES		
	MIN.	MAX.	MIN.	MAX.	
A	4.06	4.83	.160	.190	
A1		0.127		.005	
b	0.51	0.99	.020	.039	4
b1	0.51	0.89	.020	.035	
b2	1.14	1.40	.045	.055	4
c	0.43	0.63	.017	.025	
c1	0.38	0.74	.015	.029	4
c2	1.14	1.40	.045	.055	
D	8.51	9.65	.335	.380	3
D1	5.33		.210		3
E	9.65	10.67	.380	.420	
E1	6.22		.245		
e	2.54 BSC		.100 BSC		
L	14.61	15.88	.575	.625	
L1	1.78	2.79	.070	.110	
L2		1.65		.065	
L3	1.27	1.78	.050	.070	
L4	0.25 BSC		.010 BSC		
m	17.78		.700		
m1	8.89		.350		
n	11.43		.450		
o	2.08		.082		
p	3.81		.150		
θ	90°	93°	90°	93°	

LEAD ASSIGNMENTS

HEXFET	IGBTs, CoPACK	DIODES
1.- GATE	1.- GATE	1.- ANODE *
2.- DRAIN	2.- COLLECTOR	2.- CATHODE
3.- SOURCE	3.- EMITTER	3.- ANODE

* PART DEPENDENT.

NOTES:

1. DIMENSIONING AND TOLERANCING PER ASME Y14.5M-1994
2. DIMENSIONS ARE SHOWN IN MILLIMETERS [INCHES].
3. DIMENSION D & E DO NOT INCLUDE MOLD FLASH. MOLD FLASH SHALL NOT EXCEED 0.127 [0.005"] PER SIDE. THESE DIMENSIONS ARE MEASURED AT THE OUTMOST EXTREMES OF THE PLASTIC BODY.
4. DIMENSION b1 AND c1 APPLY TO BASE METAL ONLY.
5. CONTROLLING DIMENSION: INCH.

D²Pak Part Marking Information

EXAMPLE: THIS IS AN IRF530S WITH
LOT CODE 8024
ASSEMBLED ON WW02, 2000
IN THE ASSEMBLY LINE "L"

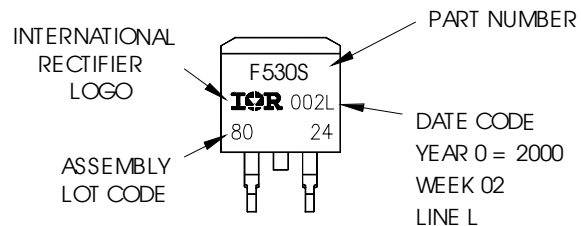

IRGB/S/SL8B60K

International
IR Rectifier

TO-262 Package Outline

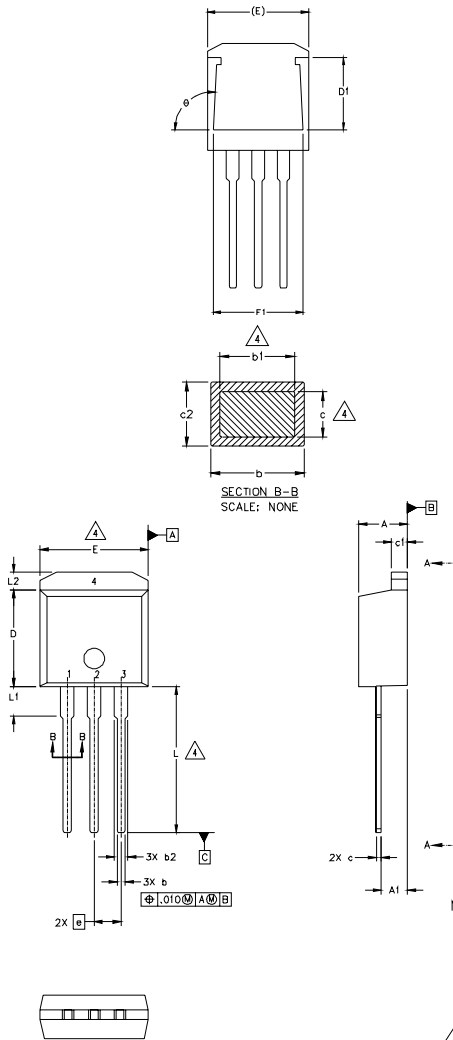

SYMBOL	DIMENSIONS				NOTES
	MILLIMETERS		INCHES		
	MIN.	MAX.	MIN.	MAX.	
A	4.06	4.83	.160	.190	
A1	2.03	2.92	.080	.115	
b	0.51	0.99	.020	.039	
b1	0.51	0.89	.020	.035	4
b2	1.14	1.40	.045	.055	
c	0.38	0.63	.015	.025	4
c1	1.14	1.40	.045	.055	
c2	0.43	.063	.017	.029	
D	8.51	9.65	.335	.380	3
D1	5.33		.210		
E	9.65	10.67	.380	.420	3
E1	6.22		.245		
e	2.54 BSC		.100 BSC		
L	13.46	14.09	.530	.555	
L1	3.56	3.71	.140	.146	
L2		1.65		.065	

LEAD ASSIGNMENTS

HEXFET	IGBT
1.- GATE	1- GATE
2.- DRAIN	2- COLLECTOR
3.- SOURCE	3- EMITTER
4.- DRAIN	

- NOTES:
1. DIMENSIONING AND TOLERANCING PER ASME Y14.5M-1994
 2. DIMENSIONS ARE SHOWN IN MILLIMETERS [INCHES].
 3. DIMENSION D & E DO NOT INCLUDE MOLD FLASH. MOLD FLASH SHALL NOT EXCEED 0.127 [.005"] PER SIDE. THESE DIMENSIONS ARE MEASURED AT THE OUTMOST EXTREMES OF THE PLASTIC BODY.
 4. DIMENSION b1 AND c1 APPLY TO BASE METAL ONLY.
 5. CONTROLLING DIMENSION: INCH.

TO-262 Part Marking Information

EXAMPLE: THIS IS AN IRL3103L
LOT CODE 1789
ASSEMBLED ON WW 19, 1997
IN THE ASSEMBLY LINE "C"

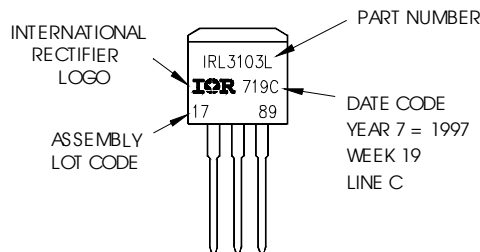

D²Pak Tape & Reel Information

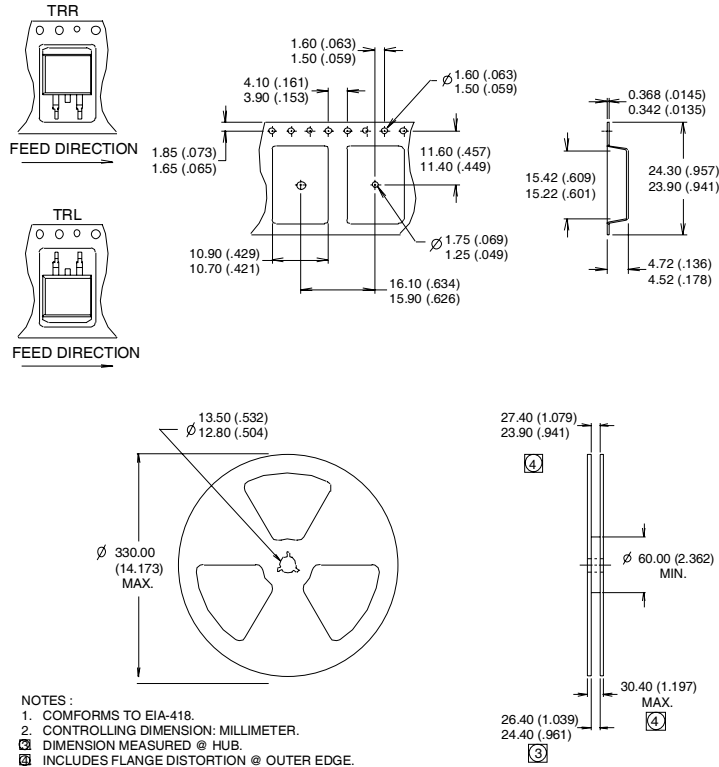

Notes:

- ① $V_{CC} = 80\% (V_{CES})$, $V_{GE} = 15V$, $L = 100\mu H$, $R_G = 50\Omega$.
- ② This is only applied to TO-220AB package.
- ③ This is applied to D²Pak, when mounted on 1" square PCB (FR-4 or G-10 Material).
For recommended footprint and soldering techniques refer to application note #AN-994.
- ④ Energy losses include "tail" and diode reverse recovery, using Diode HF03D060ACE.

TO-220AB package is not recommended for Surface Mount Application.

Data and specifications subject to change without notice.
This product has been designed and qualified for the Industrial market.
Qualification Standards can be found on IR's Web site.

International
IR Rectifier

IR WORLD HEADQUARTERS: 233 Kansas St., El Segundo, California 90245, USA Tel: (310) 252-7105
TAC Fax: (310) 252-7903

Visit us at www.irf.com for sales contact information. 10/03

Note: For the most current drawings please refer to the IR website at:
<http://www.irf.com/package/>