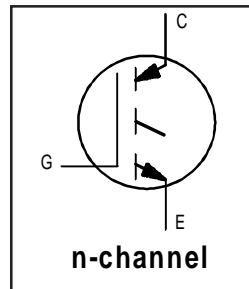


# IRG4PF50W

## INSULATED GATE BIPOLAR TRANSISTOR

### Features

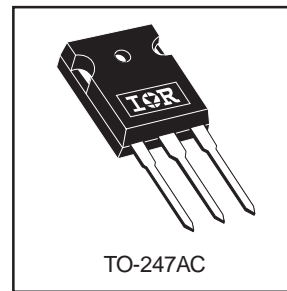
- Optimized for use in Welding and Switch-Mode Power Supply applications
- Industry benchmark switching losses improve efficiency of all power supply topologies
- 50% reduction of E<sub>off</sub> parameter
- Low IGBT conduction losses
- Latest technology IGBT design offers tighter parameter distribution coupled with exceptional reliability



$V_{CES} = 900V$
$V_{CE(on)} \text{ typ.} = 2.25V$
@ $V_{GE} = 15V, I_C = 28A$

### Benefits

- Lower switching losses allow more cost-effective operation and hence efficient replacement of larger-die MOSFETs up to 100kHz
- Of particular benefit in single-ended converters and Power Supplies 150W and higher
- Reduction in critical E<sub>off</sub> parameter due to minimal minority-carrier recombination coupled with low on-state losses allow maximum flexibility in device application



### Absolute Maximum Ratings

	Parameter	Max.	Units
$V_{CES}$	Collector-to-Emitter Breakdown Voltage	900	V
$I_C @ T_C = 25^\circ C$	Continuous Collector Current	51	A
$I_C @ T_C = 100^\circ C$	Continuous Collector Current	28	
$I_{CM}$	Pulsed Collector Current ①	204	
$I_{LM}$	Clamped Inductive Load Current ②	204	
$V_{GE}$	Gate-to-Emitter Voltage	$\pm 20$	V
$E_{ARV}$	Reverse Voltage Avalanche Energy ③	186	mJ
$P_D @ T_C = 25^\circ C$	Maximum Power Dissipation	200	W
$P_D @ T_C = 100^\circ C$	Maximum Power Dissipation	78	
$T_J$	Operating Junction and	-55 to + 150	°C
$T_{STG}$	Storage Temperature Range		
	Soldering Temperature, for 10 seconds	300 (0.063 in. (1.6mm from case )	

### Thermal Resistance

	Parameter	Typ.	Max.	Units
$R_{\theta JC}$	Junction-to-Case	—	0.64	°C/W
$R_{\theta CS}$	Case-to-Sink, Flat, Greased Surface	0.24	—	
$R_{\theta JA}$	Junction-to-Ambient, typical socket mount	—	40	
Wt	Weight	6 (0.21)	—	g (oz)

## Electrical Characteristics @ $T_J = 25^\circ\text{C}$ (unless otherwise specified)

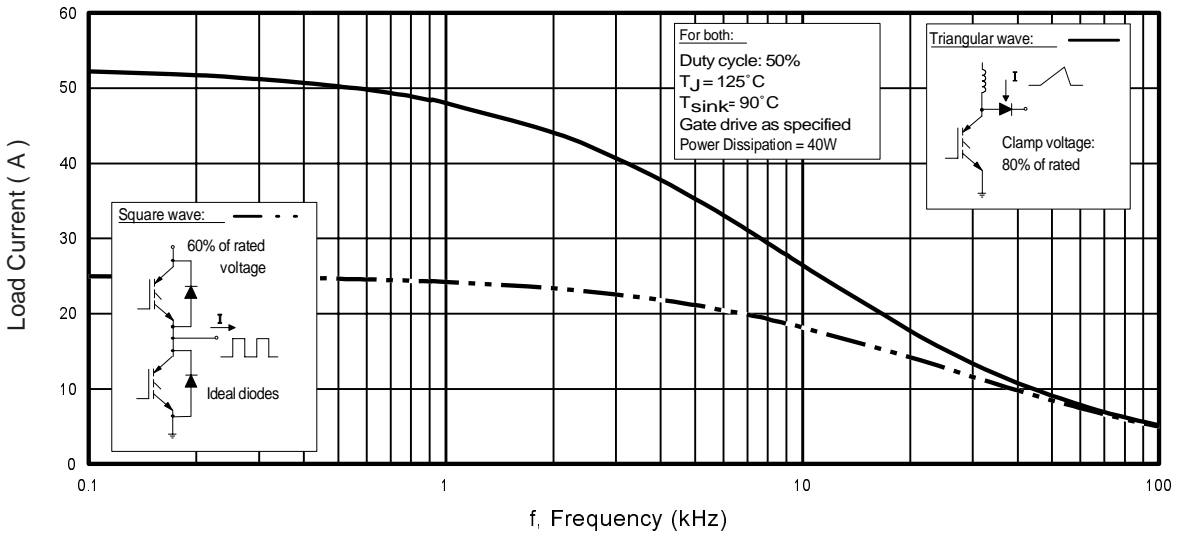
	Parameter	Min.	Typ.	Max.	Units	Conditions
$V_{(BR)CES}$	Collector-to-Emitter Breakdown Voltage	900	—	—	V	$V_{GE} = 0V, I_C = 250\mu A$
$V_{(BR)ECS}$	Emitter-to-Collector Breakdown Voltage ④	18	—	—	V	$V_{GE} = 0V, I_C = 1.0A$
$\Delta V_{(BR)CES}/\Delta T_J$	Temperature Coeff. of Breakdown Voltage	—	0.295	—	V/°C	$V_{GE} = 0V, I_C = 3.5mA$
$V_{CE(ON)}$	Collector-to-Emitter Saturation Voltage	—	2.25	2.7	V	$I_C = 28A$ $I_C = 60A$ $I_C = 28A, T_J = 150^\circ\text{C}$ $V_{GE} = 15V$ See Fig.2, 5
		—	2.74	—		
		—	2.12	—		
$V_{GE(th)}$	Gate Threshold Voltage	3.0	—	6.0		$V_{CE} = V_{GE}, I_C = 250\mu A$
$\Delta V_{GE(th)}/\Delta T_J$	Temperature Coeff. of Threshold Voltage	—	-13	—	mV/°C	$V_{CE} = V_{GE}, I_C = 1.0mA$
$g_{fe}$	Forward Transconductance ⑤	26	39	—	S	$V_{CE} \geq 15V, I_C = 28A$
$I_{CES}$	Zero Gate Voltage Collector Current	—	—	500	$\mu A$	$V_{GE} = 0V, V_{CE} = 900V$
		—	—	2.0		$V_{GE} = 0V, V_{CE} = 10V, T_J = 25^\circ\text{C}$
		—	—	5.0	mA	$V_{GE} = 0V, V_{CE} = 900V, T_J = 150^\circ\text{C}$
$I_{GES}$	Gate-to-Emitter Leakage Current	—	—	$\pm 100$	nA	$V_{GE} = \pm 20V$

## Switching Characteristics @ $T_J = 25^\circ\text{C}$ (unless otherwise specified)

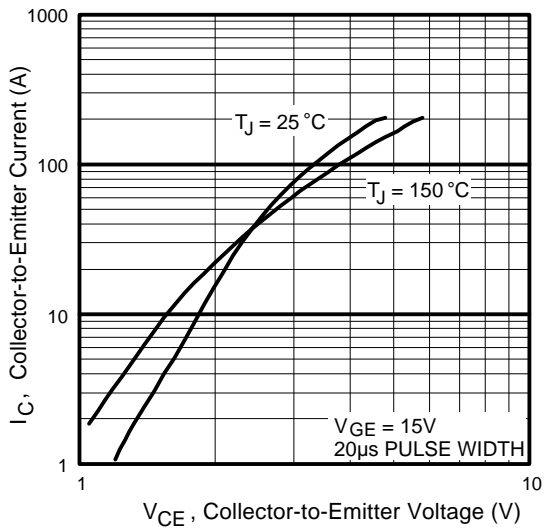
	Parameter	Min.	Typ.	Max.	Units	Conditions
$Q_g$	Total Gate Charge (turn-on)	—	160	240	nC	$I_C = 28A$ $V_{CC} = 400V$ $V_{GE} = 15V$ See Fig. 8
$Q_{ge}$	Gate - Emitter Charge (turn-on)	—	19	29		
$Q_{gc}$	Gate - Collector Charge (turn-on)	—	53	80		
$t_{d(on)}$	Turn-On Delay Time	—	29	—	ns	$T_J = 25^\circ\text{C}$ $I_C = 28A, V_{CC} = 720V$ $V_{GE} = 15V, R_G = 5.0\Omega$ Energy losses include "tail" See Fig. 10, 11, 13, 14
$t_r$	Rise Time	—	26	—		
$t_{d(off)}$	Turn-Off Delay Time	—	110	170		
$t_f$	Fall Time	—	150	220		
$E_{on}$	Turn-On Switching Loss	—	0.19	—	mJ	See Fig. 10, 11, 13, 14
$E_{off}$	Turn-Off Switching Loss	—	1.06	—		
$E_{ts}$	Total Switching Loss	—	1.25	1.7		
$t_{d(on)}$	Turn-On Delay Time	—	28	—	ns	$T_J = 150^\circ\text{C},$ $I_C = 28A, V_{CC} = 720V$ $V_{GE} = 15V, R_G = 5.0\Omega$ Energy losses include "tail" See Fig. 13, 14
$t_r$	Rise Time	—	26	—		
$t_{d(off)}$	Turn-Off Delay Time	—	280	—		
$t_f$	Fall Time	—	90	—		
$E_{ts}$	Total Switching Loss	—	3.45	—	mJ	
$L_E$	Internal Emitter Inductance	—	13	—	nH	Measured 5mm from package
$C_{ies}$	Input Capacitance	—	3300	—	pF	$V_{GE} = 0V$ $V_{CC} = 30V$ $f = 1.0MHz$ See Fig. 7
$C_{oes}$	Output Capacitance	—	200	—		
$C_{res}$	Reverse Transfer Capacitance	—	45	—		

### Notes:

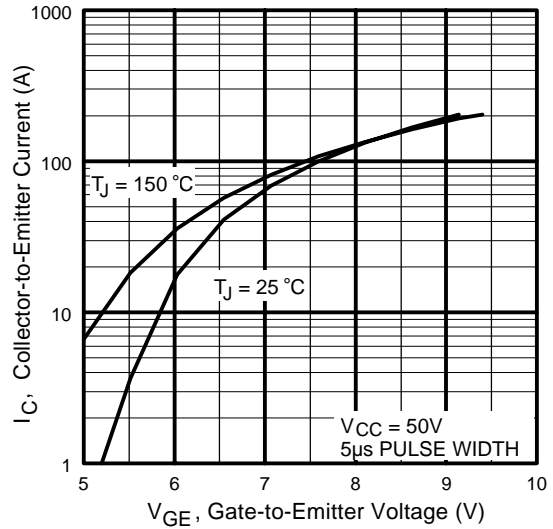
- ① Repetitive rating;  $V_{GE} = 20V$ , pulse width limited by max. junction temperature. ( See fig. 13b )
- ②  $V_{CC} = 80\%(V_{CES}), V_{GE} = 20V, L = 10\mu H, R_G = 5.0\Omega,$  (See fig. 13a)
- ③ Repetitive rating; pulse width limited by maximum junction temperature.
- ④ Pulse width  $\leq 80\mu s$ ; duty factor  $\leq 0.1\%$ .
- ⑤ Pulse width  $5.0\mu s$ , single shot.



**Fig. 1 - Typical Load Current vs. Frequency**  
(For square wave,  $I = I_{RMS}$  of fundamental; for triangular wave,  $I = I_{PK}$ )



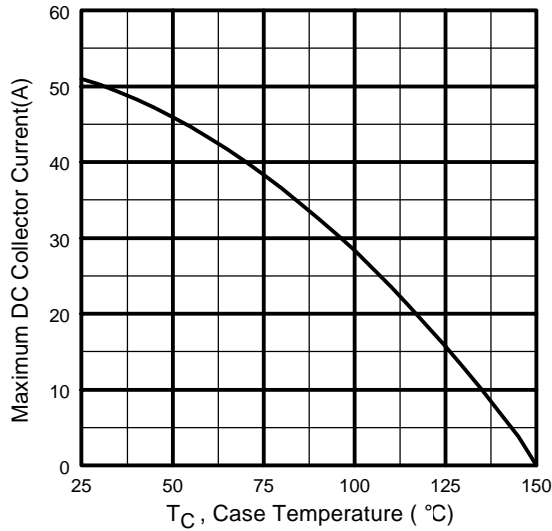
**Fig. 2 - Typical Output Characteristics**



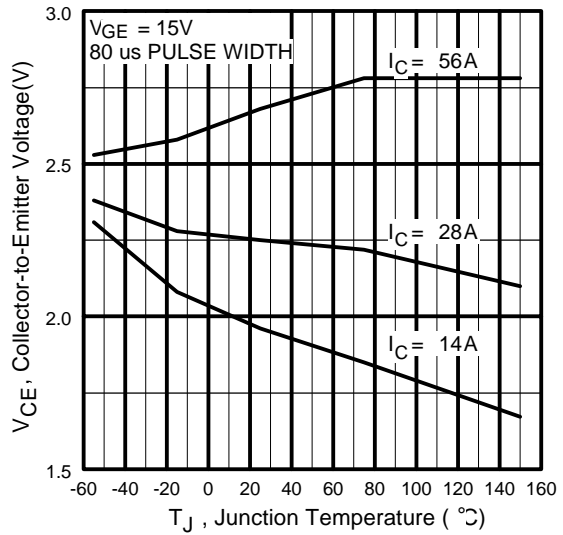
**Fig. 3 - Typical Transfer Characteristics**

# IRG4PF50W

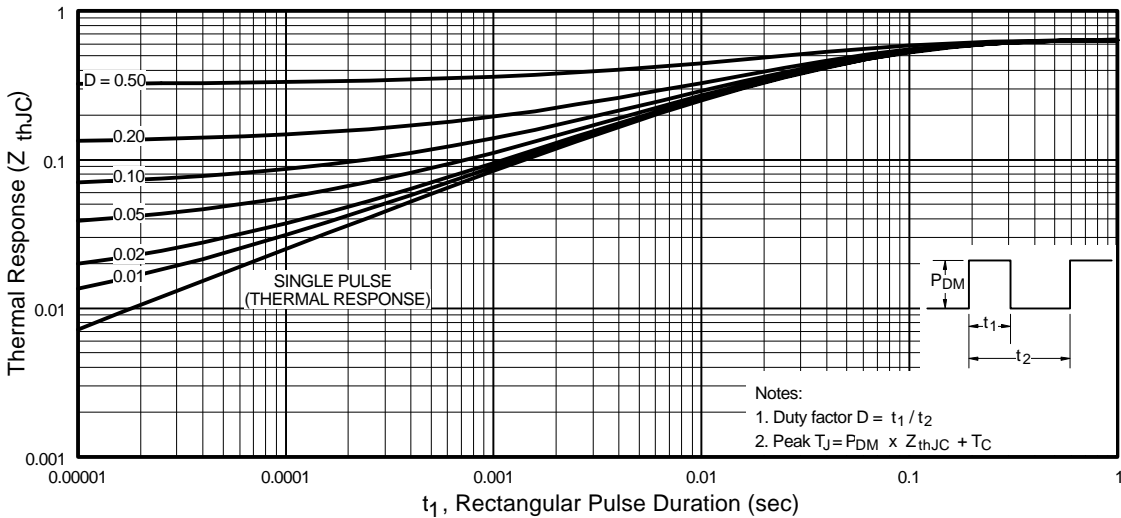
International  
**IRF** Rectifier



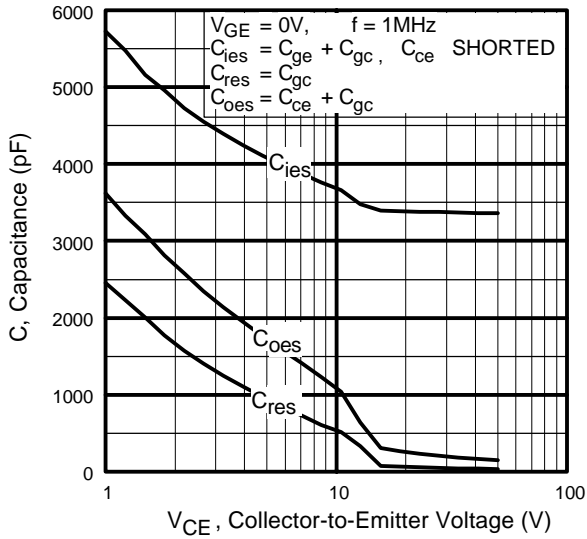
**Fig. 4** - Maximum Collector Current vs. Case Temperature



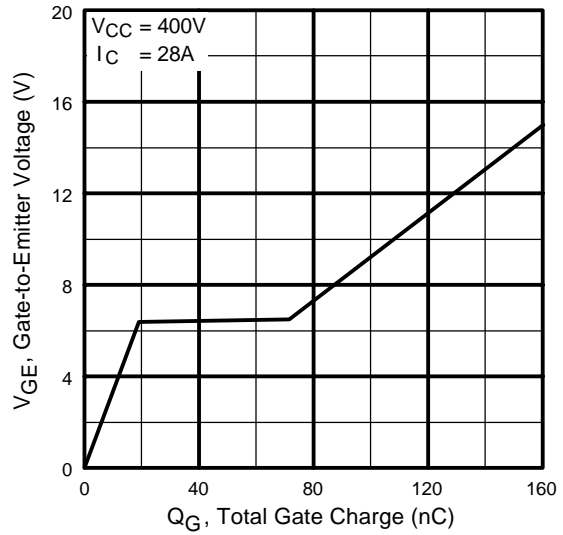
**Fig. 5** - Collector-to-Emitter Voltage vs. Junction Temperature



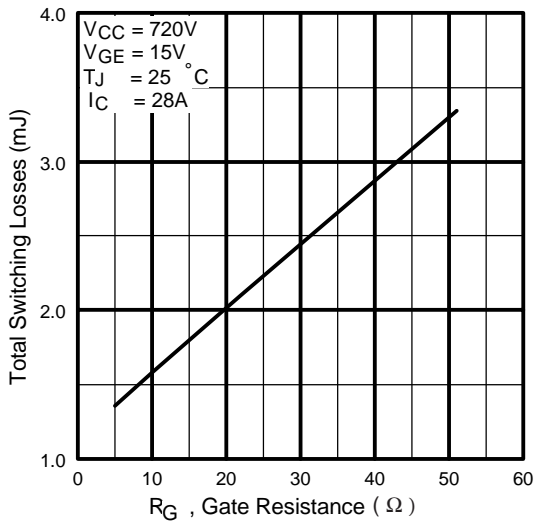
**Fig. 6** - Maximum Effective Transient Thermal Impedance, Junction-to-Case



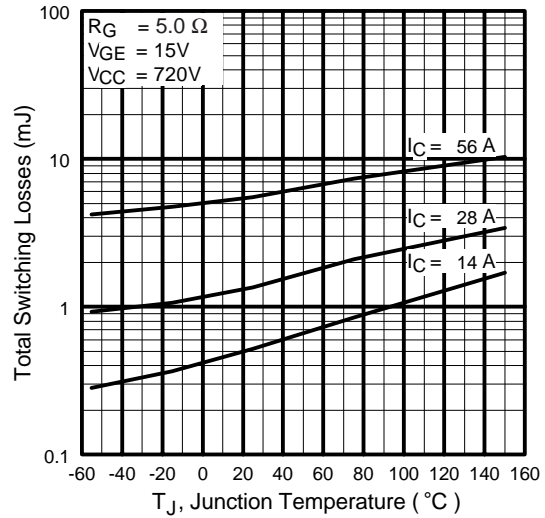
**Fig. 7** - Typical Capacitance vs. Collector-to-Emitter Voltage



**Fig. 8** - Typical Gate Charge vs. Gate-to-Emitter Voltage



**Fig. 9** - Typical Switching Losses vs. Gate Resistance



**Fig. 10** - Typical Switching Losses vs. Junction Temperature

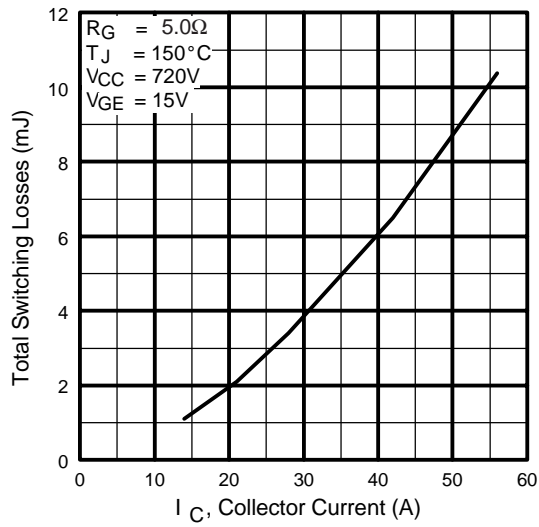


Fig. 11 - Typical Switching Losses vs. Collector-to-Emitter Current

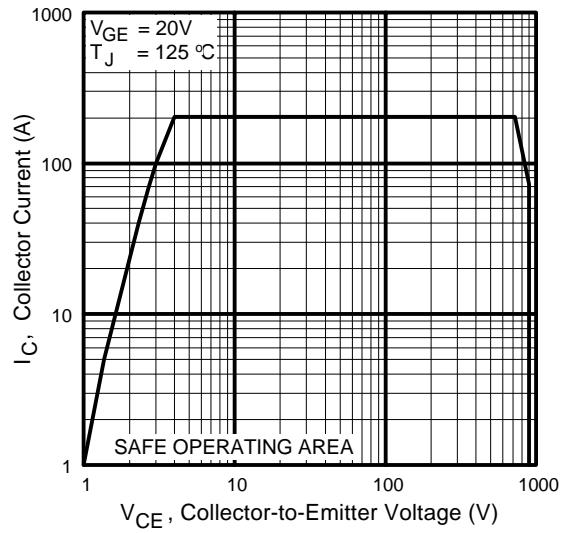
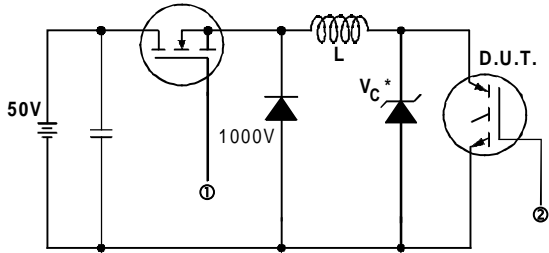
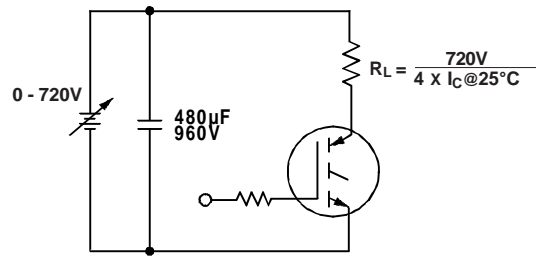


Fig. 12 - Turn-Off SOA

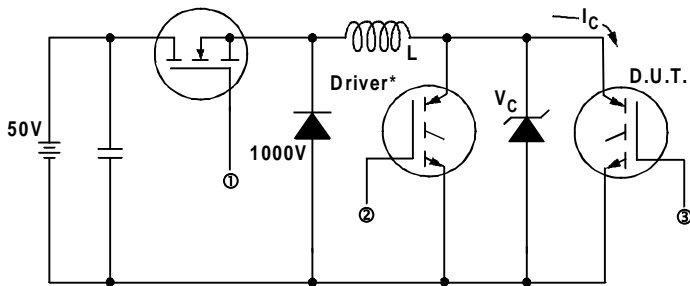


\* Driver same type as D.U.T.;  $V_c = 80\%$  of  $V_{ce(max)}$   
 \* Note: Due to the 50V power supply, pulse width and inductor will increase to obtain rated  $I_d$ .

**Fig. 13a** - Clamped Inductive Load Test Circuit

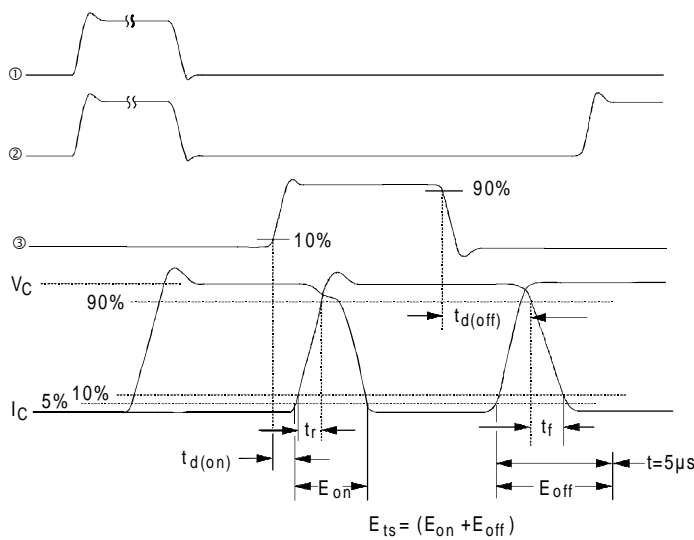


**Fig. 13b** - Pulsed Collector Current Test Circuit



**Fig. 14a** - Switching Loss Test Circuit

\* Driver same type as D.U.T.,  $V_C = 720V$

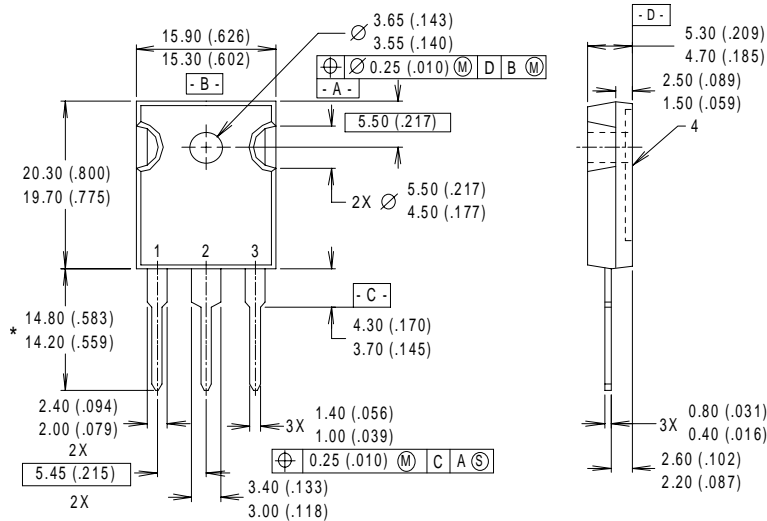


**Fig. 14b** - Switching Loss Waveforms

# IRG4PF50W

International  
**IR** Rectifier

## Case Outline and Dimensions — TO-247AC



### NOTES:

- 1 DIMENSIONS & TOLERANCING PER ANSI Y14.5M, 1982.
- 2 CONTROLLING DIMENSION : INCH.
- 3 DIMENSIONS ARE SHOWN MILLIMETERS (INCHES).
- 4 CONFORMS TO JEDEC OUTLINE TO-247AC.

### LEAD ASSIGNMENTS

- 1 - GATE
- 2 - COLLECTOR
- 3 - EMITTER
- 4 - COLLECTOR

\* LONGER LEADED (20mm) VERSION AVAILABLE (TO-247AD) TO ORDER ADD "-E" SUFFIX TO PART NUMBER

**CONFORMS TO JEDEC OUTLINE TO-247AC (TO-3P)**

Dimensions in Millimeters and (Inches)

International  
**IR** Rectifier

**WORLD HEADQUARTERS:** 233 Kansas St., El Segundo, California 90245, Tel: (310) 322 3331

**EUROPEAN HEADQUARTERS:** Hurst Green, Oxted, Surrey RH8 9BB, UK Tel: ++ 44 1883 732020

**IR CANADA:** 15 Lincoln Court, Brampton, Ontario L6T 3Z2, Tel: (905) 453 2200

**IR GERMANY:** Saalburgstrasse 157, 61350 Bad Homburg Tel: ++ 49 6172 96590

**IR ITALY:** Via Liguria 49, 10071 Borgaro, Torino Tel: ++ 39 11 451 0111

**IR FAR EAST:** 171 (K&H Bldg.) 30-4 Nishi-ikebukuro 3-chome, Toshima-ku, Tokyo Japan Tel: 81 33 983 0086

**IR SOUTHEAST ASIA:** 315 Outram Road, #10-02 Tan Boon Liat Building, Singapore 16907 Tel: 65 221 8371

Data and specifications subject to change without notice.

4/98



Note: For the most current drawings please refer to the IR website at:  
<http://www.irf.com/package/>