

FAN1112

1A 1.2V Low Dropout Linear Regulator

Features

- Low dropout voltage
- Load regulation: 0.05% typical
- Trimmed current limit
- On-chip thermal limiting
- Standard SOT-223 and TO-252 packages
- Three-terminal fixed 1.2V

Applications

- Post regulator for switching supplies
- Supply for low-voltage processors

Description

The FAN1112 is a 1.2V low dropout three-terminal regulator with 1A output current capability. The device has been optimized for low voltage where transient response and minimum input voltage are critical.

Current limit is trimmed to ensure specified output current and controlled short-circuit current. On-chip thermal limiting provides protection against any combination of overload and ambient temperatures that would create excessive junction temperatures.

Unlike PNP type regulators where up to 10% of the output current is wasted as quiescent current, the quiescent current of the FAN1112 flows into the load, increasing efficiency.

The FAN1112 regulator is available in the industry-standard SOT-223 and TO-252 (DPAK) power packages.

Typical Application

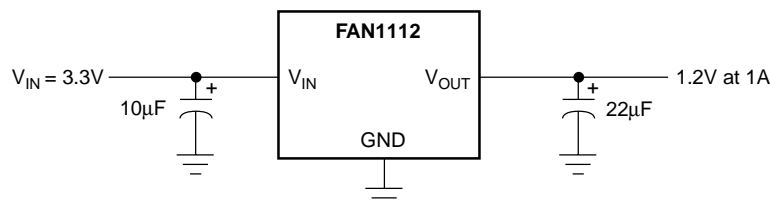

Pin Assignments

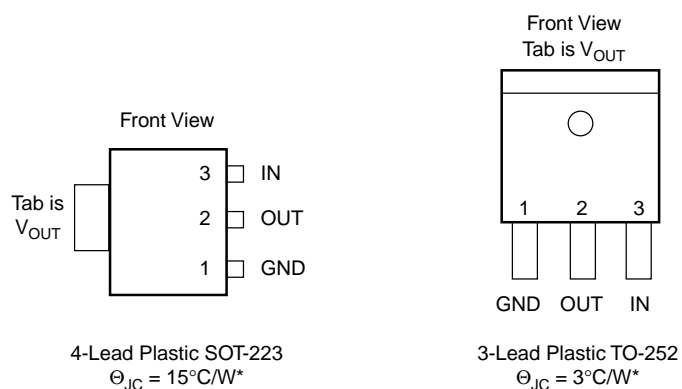

*With package soldered to 0.5 square inch copper area over backside ground plane or internal power plane., Θ_{JA} can vary from 30°C/W to more than 50°C/W . Other mounting techniques may provide better thermal resistance than 30°C/W .

Absolute Maximum Ratings

| Parameter | Min. | Max. | Unit |
|---------------------------------------|------|--------------|--------------------|
| V_{IN} | | 18 | V |
| $(V_{IN} - V_{OUT}) * I_{OUT}$ | | See Figure 1 | |
| Operating Junction Temperature Range | 0 | 125 | $^{\circ}\text{C}$ |
| Storage Temperature Range | -65 | 150 | $^{\circ}\text{C}$ |
| Lead Temperature (Soldering, 10 sec.) | | 300 | $^{\circ}\text{C}$ |

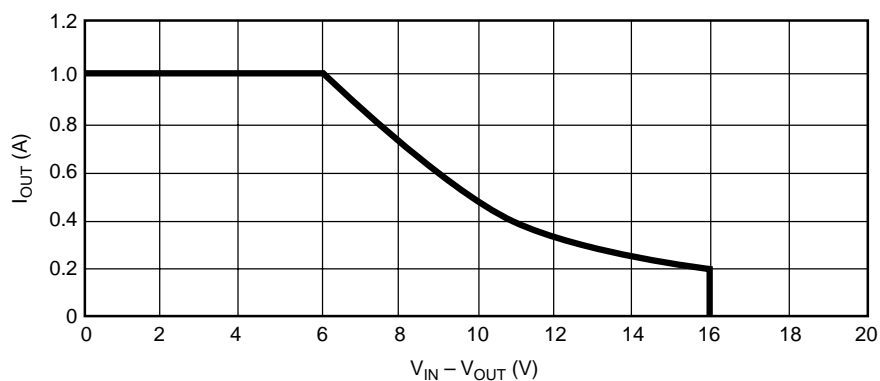

Figure 1. Absolute Maximum Safe Operating Area

Electrical Characteristics

Operating Conditions: $V_{IN} \leq 7V$, $T_J = 25^\circ C$ unless otherwise specified.

The • denotes specifications which apply over the specified operating temperature range.

| Parameter | Conditions | Min. | Typ. | Max. | Units |
|---|---|---------|-------|-------|--------------|
| Output Voltage ³ | $10mA \leq I_{OUT} \leq 1A$ FAN1112, $3.0V \leq V_{IN} \leq 7.2V$ | • 1.140 | 1.200 | 1.260 | V |
| Line Regulation ^{1,2} | $3.0V \leq V_{IN} \leq 12V$, $I_{OUT} = 10mA$ | • | 0.005 | 0.2 | % |
| Load Regulation ^{1,2} | $(V_{IN} - V_{OUT}) = 2V$, $10mA \leq I_{OUT} \leq 1A$ | • | 0.05 | 0.5 | % |
| Dropout Voltage | $\Delta V_{REF} = 1\%$, $I_{OUT} = 1A$ | • | 1.100 | 1.200 | V |
| Current Limit | $(V_{IN} - V_{OUT}) = 2V$ | • 1.1 | 1.5 | | A |
| GND Pin Current | | • | 35 | 120 | μA |
| GND Pin Current Change | $3.0V \leq V_{IN} \leq 7V$, $10mA \leq I_{OUT} \leq 1A$ | • | 0.2 | 5 | μA |
| Minimum Load Current | $3.0V \leq V_{IN} \leq 15V$ | • 10 | | | mA |
| Quiescent Current | $V_{IN} = 7V$ | • | 4 | 13 | mA |
| Ripple Rejection | $f = 120Hz$, $C_{OUT} = 22\mu F$ Tantalum, $(V_{IN} - V_{OUT}) = 3V$, $I_{OUT} = 1A$ | | 60 | 72 | dB |
| Thermal Regulation | $T_A = 25^\circ C$, 30ms pulse | | 0.004 | 0.02 | %/W |
| Temperature Stability | | • | 0.5 | | % |
| Long-Term Stability | $T_A = 125^\circ C$, 1000hrs. | | 0.03 | 1.0 | % |
| RMS Output Noise (% of V_{OUT}) | $T_A = 25^\circ C$, $10Hz \leq f \leq 10kHz$ | | 0.003 | | % |
| Thermal Resistance, Junction to Case | SOT-223 | | 15 | | $^\circ C/W$ |
| | TO-252 | | 3 | | $^\circ C/W$ |
| Thermal Shutdown | Junction Temperature | | 155 | | $^\circ C$ |
| Thermal Shutdown Hysteresis | | | 10 | | $^\circ C$ |

Notes:

1. See thermal regulation specifications for changes in output voltage due to heating effects. Load and line regulation are measured at a constant junction temperature by low duty cycle pulse testing.
2. Line and load regulation are guaranteed up to the maximum power dissipation (18W). Power dissipation is determined by input/output differential and the output current. Guaranteed maximum output power will not be available over the full input/output voltage range.
3. Output current must be limited to meet the absolute maximum ratings of the part.

Typical Performance Characteristics

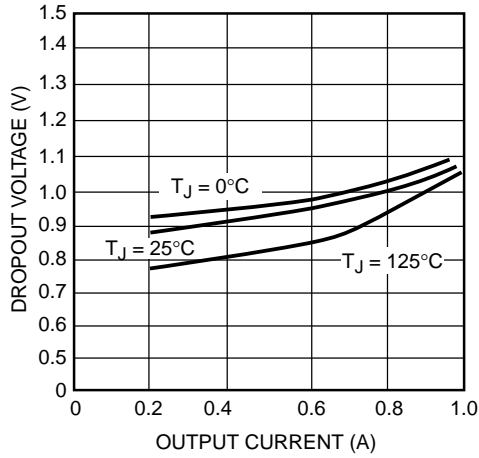

Figure 2. Dropout Voltage vs. Output Current

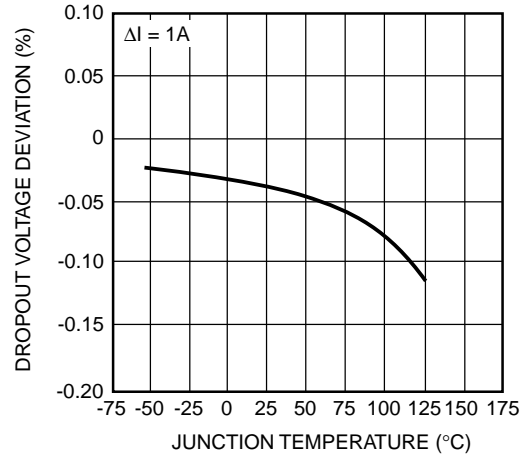

Figure 3. Load Regulation vs. Temperature

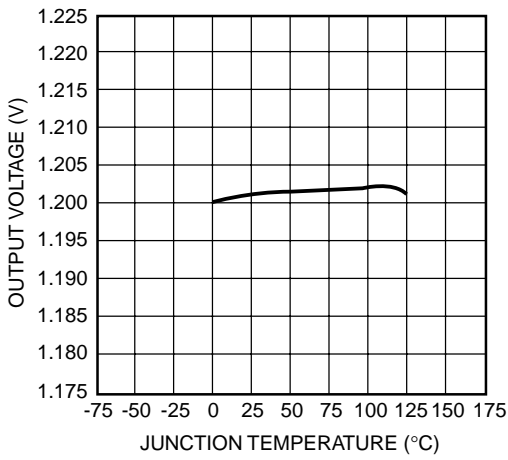

Figure 4. Reference Voltage vs. Temperature

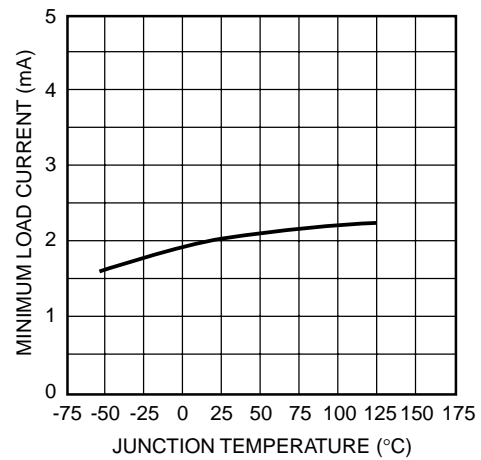

Figure 5. Minimum Load Current vs. Temperature

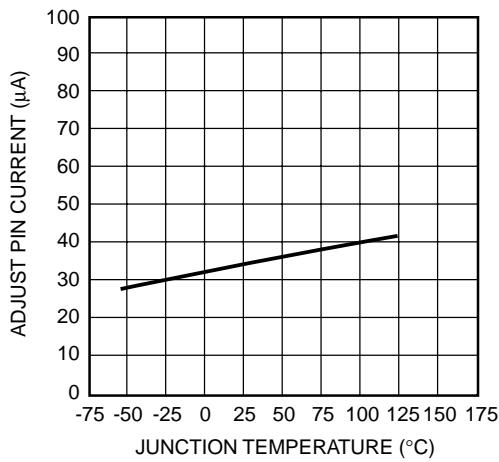

Figure 6. GND Pin Current vs. Temperature

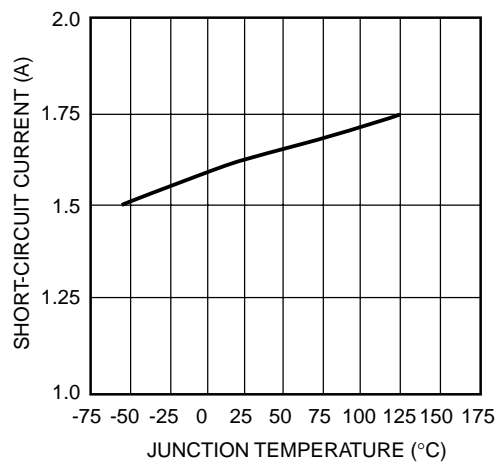

Figure 7. Short-Circuit Current vs. Temperature

Typical Performance Characteristics (continued)

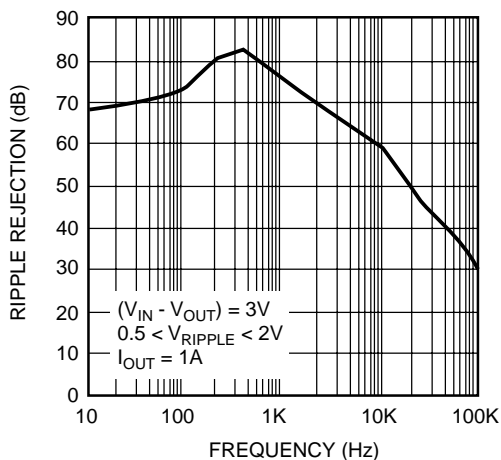

Figure 8. Ripple Rejection vs. Frequency

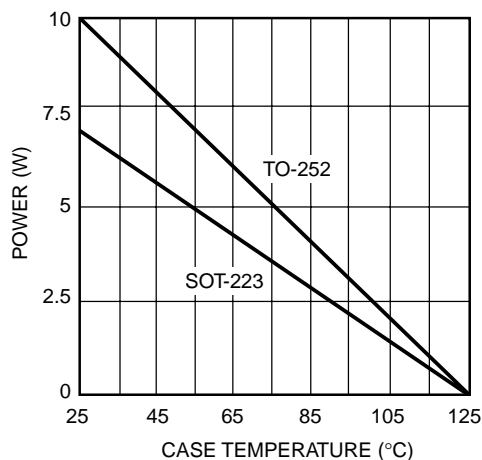
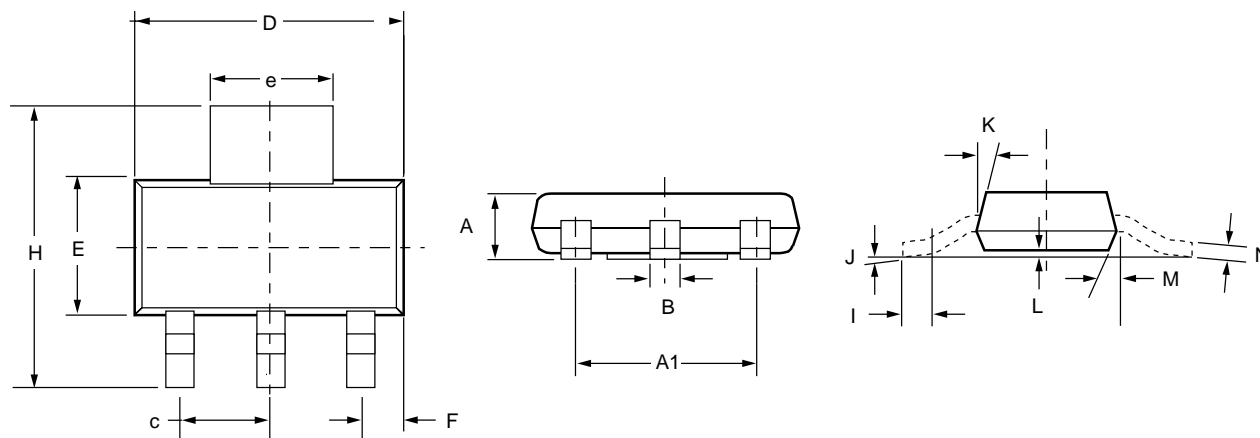

Figure 9. Maximum Power Dissipation

Mechanical Dimensions

4-Lead SOT-223 Package

| Symbol | Inches | | Millimeters | | Notes |
|--------|--------|-------|-------------|-------|-------|
| | Min. | Max. | Min. | Max. | |
| A | — | .071 | — | 1.80 | |
| A1 | — | .181 | — | 4.80 | |
| B | .025 | .033 | .640 | .840 | |
| c | — | .090 | — | 2.29 | |
| D | .248 | .264 | 6.30 | 6.71 | |
| E | .130 | .148 | 3.30 | 3.71 | |
| e | .115 | .124 | 2.95 | 3.15 | |
| F | .033 | .041 | .840 | 1.04 | |
| H | .264 | .287 | 6.71 | 7.29 | |
| I | .012 | — | .310 | — | |
| J | — | 10° | — | 10° | |
| K | 10° | 16° | 10° | 16° | |
| L | .0008 | .0040 | .0203 | .1018 | |
| M | 10° | 16° | 10° | 16° | |
| N | .010 | .014 | .250 | .360 | |



Mechanical Dimensions (continued)

3-Lead TO-252 Package

| Symbol | Inches | | Millimeters | | Notes |
|--------|----------|------|-------------|-------|-------|
| | Min. | Max. | Min. | Max. | |
| A | .086 | .094 | 2.19 | 2.39 | |
| b | .025 | .035 | 0.64 | 0.89 | |
| b2 | .030 | .045 | 0.76 | 1.14 | |
| b3 | .205 | .215 | 5.21 | 5.46 | 4 |
| c | .018 | .024 | 0.46 | 0.61 | |
| c2 | .018 | .023 | 0.46 | 0.58 | |
| D | .210 | .245 | 5.33 | 6.22 | 1 |
| E | .250 | .265 | 6.35 | 6.73 | 1 |
| e | .090 BSC | | 2.29 BSC | | |
| H | .370 | .410 | 9.40 | 10.41 | |
| L | .055 | .070 | 1.40 | 1.78 | 3 |
| L1 | .108 REF | | 2.74 REF | | |
| L3 | .035 | .080 | 0.89 | 2.03 | 4 |
| L4 | .025 | .040 | 0.64 | 1.02 | |

Notes:

1. Dimensions are exclusive of mold flash, metal burrs or interlead protrusion.
2. Stand off-height is measured from lead tip with ref. to Datum -B-.
3. Foot length is measured with ref. to Datum -A- with lead surface.
4. Thermal pad contour optional within dimension b3 and L3.
5. Formed leads to be planar with respect to one another at seating place -C-.
6. Dimensions and tolerances per ASME Y14.5M-1994.

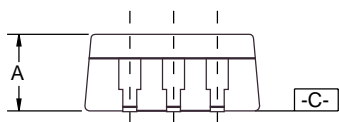
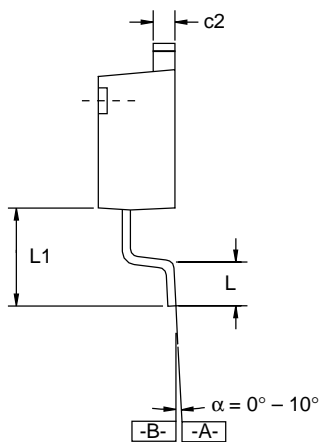
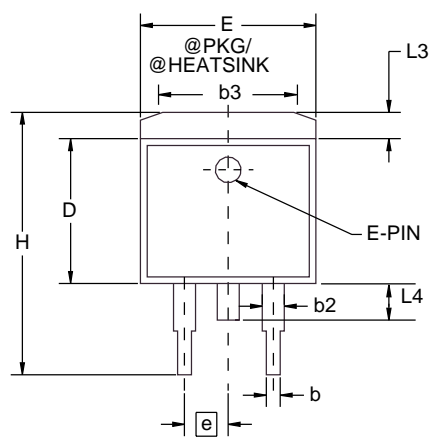

Ordering Information

| Product Number | Package |
|----------------|---------|
| FAN1112D | TO-252 |
| FAN1112S | SOT-223 |

DISCLAIMER

FAIRCHILD SEMICONDUCTOR RESERVES THE RIGHT TO MAKE CHANGES WITHOUT FURTHER NOTICE TO ANY PRODUCTS HEREIN TO IMPROVE RELIABILITY, FUNCTION OR DESIGN. FAIRCHILD DOES NOT ASSUME ANY LIABILITY ARISING OUT OF THE APPLICATION OR USE OF ANY PRODUCT OR CIRCUIT DESCRIBED HEREIN; NEITHER DOES IT CONVEY ANY LICENSE UNDER ITS PATENT RIGHTS, NOR THE RIGHTS OF OTHERS.

LIFE SUPPORT POLICY

FAIRCHILD'S PRODUCTS ARE NOT AUTHORIZED FOR USE AS CRITICAL COMPONENTS IN LIFE SUPPORT DEVICES OR SYSTEMS WITHOUT THE EXPRESS WRITTEN APPROVAL OF THE PRESIDENT OF FAIRCHILD SEMICONDUCTOR CORPORATION. As used herein:

1. Life support devices or systems are devices or systems which, (a) are intended for surgical implant into the body, or (b) support or sustain life, and (c) whose failure to perform when properly used in accordance with instructions for use provided in the labeling, can be reasonably expected to result in a significant injury of the user.
2. A critical component in any component of a life support device or system whose failure to perform can be reasonably expected to cause the failure of the life support device or system, or to affect its safety or effectiveness.

www.fairchildsemi.com