

**NICHIA CORPORATION**

## **SPECIFICATIONS FOR WHITE LED**

### **NSSW006T**

- Pb-free Reflow Soldering Application
- RoHS Compliant

## SPECIFICATIONS

### (1) Absolute Maximum Ratings

| Item                  | Symbol    | Absolute Maximum Rating | Unit |
|-----------------------|-----------|-------------------------|------|
| Forward Current       | $I_F$     | 35                      | mA   |
| Pulse Forward Current | $I_{FP}$  | 100                     | mA   |
| Reverse Voltage       | $V_R$     | 5                       | V    |
| Power Dissipation     | $P_D$     | 123                     | mW   |
| Operating Temperature | $T_{opr}$ | -30~85                  | °C   |
| Storage Temperature   | $T_{stg}$ | -40~100                 | °C   |
| Junction Temperature  | $T_J$     | 103                     | °C   |

\* Absolute Maximum Ratings at  $T_A=25^{\circ}\text{C}$ .

\*  $I_{FP}$  conditions with pulse width  $\leq 10\text{ms}$  and duty cycle  $\leq 10\%$ .

### (2) Initial Electrical/Optical Characteristics

| Item   | Symbol   | Condition         | Typ   | Unit |
|--|----------|-------------------|-------|------|
| Forward Voltage                                  | $V_F$    | $I_F=20\text{mA}$ | 3.2   | V    |
| Luminous Intensity<br>(Chromaticity Coordinate1) | $I_v$    | $I_F=20\text{mA}$ | 2.2   | cd   |
| Luminous Flux<br>(Chromaticity Coordinate1)      | $\Phi_v$ | $I_F=20\text{mA}$ | 5.9   | lm   |
| Chromaticity Coordinate1                         | x        | $I_F=20\text{mA}$ | 0.31  | -    |
|  | y        | $I_F=20\text{mA}$ | 0.32  | -    |
| Luminous Intensity<br>(Chromaticity Coordinate2) | $I_v$    | $I_F=20\text{mA}$ | 2.05  | cd   |
| Luminous Flux<br>(Chromaticity Coordinate2)      | $\Phi_v$ | $I_F=20\text{mA}$ | 5.5   | lm   |
| Chromaticity Coordinate2                         | x        | $I_F=20\text{mA}$ | 0.300 | -    |
|  | y        | $I_F=20\text{mA}$ | 0.295 | -    |

\* Characteristics at  $T_A = 25^{\circ}\text{C}$ .

\* The Chromaticity Coordinates are derived from the CIE 1931 Chromaticity Diagram.

## RANKS

| Item               | Rank | Min | Max | Unit |
|--------------------|------|-----|-----|------|
| Forward Voltage    | -    | 2.8 | 3.5 | V    |
| Reverse Current    | -    | -   | 50  | μA   |
| Luminous Intensity | A22  | 2.2 | 2.3 | cd   |
|                    | A21  | 2.1 | 2.2 |      |
|                    | A20  | 2.0 | 2.1 |      |
|                    | A19  | 1.9 | 2.0 |      |
|                    | A18  | 1.8 | 1.9 |      |
|                    | A17  | 1.7 | 1.8 |      |
|                    | A16  | 1.6 | 1.7 |      |

### Color Ranks

|   | Rank a52 |        |        |        |
|---|----------|--------|--------|--------|
| x | 0.2800   | 0.2720 | 0.2820 | 0.2880 |
| y | 0.2480   | 0.2580 | 0.2720 | 0.2620 |

|   | Rank a56 |        |        |        |
|---|----------|--------|--------|--------|
| x | 0.2830   | 0.2800 | 0.2880 | 0.2910 |
| y | 0.2440   | 0.2480 | 0.2620 | 0.2580 |

|   | Rank a57 |        |        |
|---|----------|--------|--------|
| x | 0.2720   | 0.2793 | 0.2820 |
| y | 0.2580   | 0.2755 | 0.2720 |

|   | Rank a62 |        |        |        |
|---|----------|--------|--------|--------|
| x | 0.2880   | 0.2820 | 0.2910 | 0.2960 |
| y | 0.2620   | 0.2720 | 0.2870 | 0.2760 |

|   | Rank a66 |        |        |        |
|---|----------|--------|--------|--------|
| x | 0.2910   | 0.2880 | 0.2960 | 0.2980 |
| y | 0.2580   | 0.2620 | 0.2760 | 0.2710 |

|   | Rank a67 |        |        |        |
|---|----------|--------|--------|--------|
| x | 0.2820   | 0.2793 | 0.2887 | 0.2910 |
| y | 0.2720   | 0.2755 | 0.2916 | 0.2870 |

|   | Rank bj2 |        |        |        |
|---|----------|--------|--------|--------|
| x | 0.2960   | 0.2910 | 0.2990 | 0.3040 |
| y | 0.2760   | 0.2870 | 0.3010 | 0.2900 |

|   | Rank bj6 |        |        |        |
|---|----------|--------|--------|--------|
| x | 0.2980   | 0.2960 | 0.3040 | 0.3062 |
| y | 0.2710   | 0.2760 | 0.2900 | 0.2853 |

|   | Rank bj7 |        |        |        |
|---|----------|--------|--------|--------|
| x | 0.2910   | 0.2887 | 0.2968 | 0.2990 |
| y | 0.2870   | 0.2916 | 0.3058 | 0.3010 |

|   | Rank bk2 |        |        |        |
|---|----------|--------|--------|--------|
| x | 0.3040   | 0.2990 | 0.3070 | 0.3120 |
| y | 0.2900   | 0.3010 | 0.3150 | 0.3040 |

|   | Rank bk6 |        |        |        |
|---|----------|--------|--------|--------|
| x | 0.3062   | 0.3040 | 0.3120 | 0.3142 |
| y | 0.2853   | 0.2900 | 0.3040 | 0.2993 |

|   | Rank bk7 |        |        |        |
|---|----------|--------|--------|--------|
| x | 0.2990   | 0.2968 | 0.3048 | 0.3070 |
| y | 0.3010   | 0.3058 | 0.3198 | 0.3150 |

- \* Ranking at  $T_A=25^{\circ}\text{C}$ .
- \* Reverse Current at  $V_R=5\text{V}$ .
- \* Tolerance of measurements of the Forward Voltage is  $\pm 3\%$ .
- \* Tolerance of measurements of the Luminous Intensity is  $\pm 7\%$ .
- \* Tolerance of measurements of the Chromaticity Coordinate is  $\pm 0.005$ .
- \* Basically, a shipment shall consist of the LEDs of a combination of the above ranks.  
The percentage of each rank in the shipment shall be determined by Nichia.

CHROMATICITY DIAGRAM

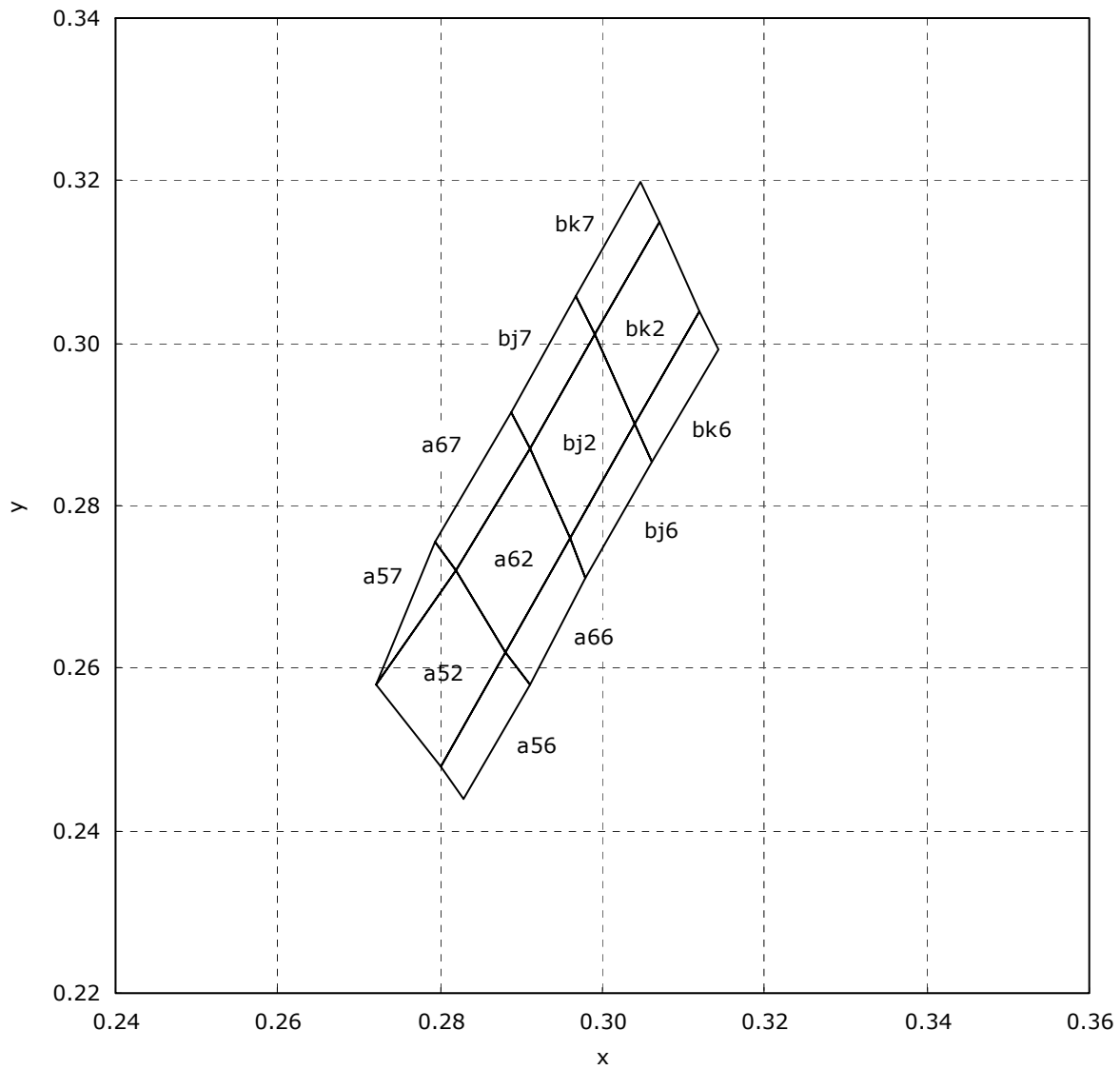

# OUTLINE DIMENSIONS

\* 本製品はRoHS指令に適合しております。  
This product complies with RoHS Directive.

NSSW006  
管理番号 No. STS-DA7-0434

(単位 Unit: mm, 公差 Tolerance: ±0.1)

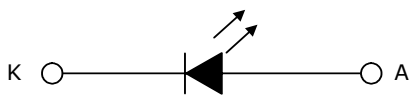
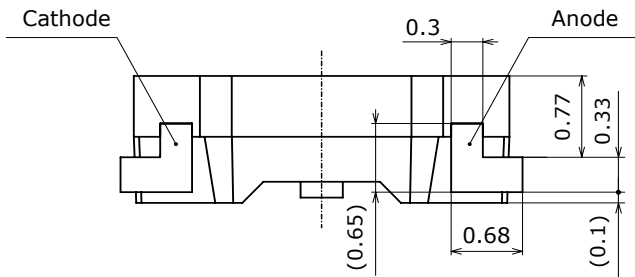
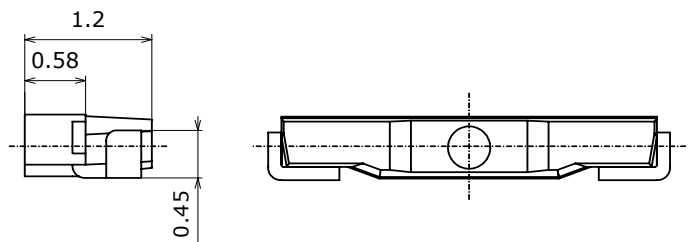
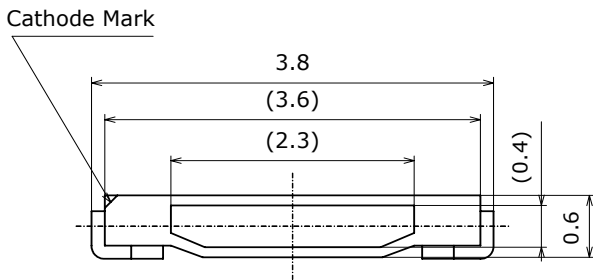
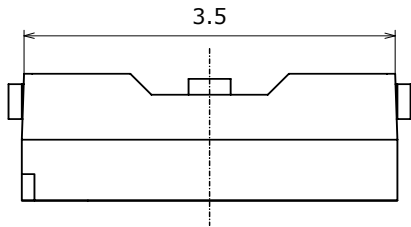

| 項目 Item                                    | 内容 Description  |
|--|---|
| パッケージ材質<br>Package Materials               | 耐熱性ポリマー<br>Heat-Resistant Polymer                                       |
| 封止樹脂材質<br>Encapsulating Resin<br>Materials | シリコン樹脂<br>(拡散剤+蛍光体入り)<br>Silicone Resin<br>(with diffuser and phosphor) |
| 電極材質<br>Electrodes Materials               | 銅合金+銀メッキ<br>Ag-plated Copper Alloy                                      |
| 質量<br>Weight                               | 0.0049g(TYP)  |

\* バリは寸法に含まないものとします。  
Dimensions do not include mold flash or metal burr.

## SOLDERING

### • Recommended Reflow Soldering Condition(Lead-free Solder)

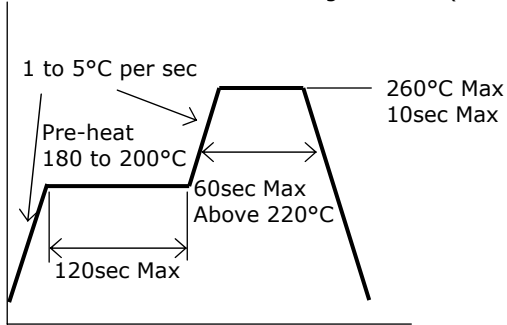

### • Recommended Manual Soldering Condition

|                |           |
|----------------|-----------|
| Temperature    | 350°C Max |
| Soldering Time | 3sec Max  |

### • Recommended Soldering Pad Pattern

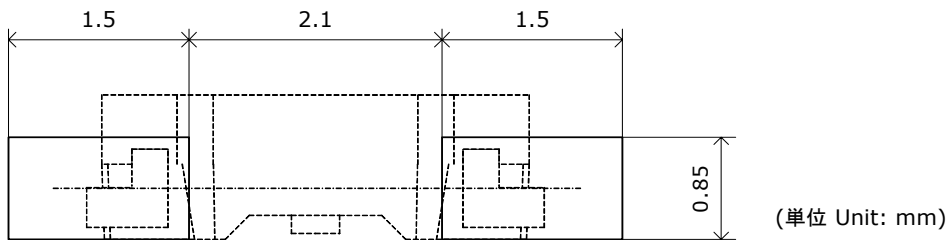

- \* The product is designed to be reflow soldered to a PCB. If you use dip soldering for the products, Nichia cannot guarantee its reliability.
- \* Reflow soldering must not be performed more than twice. Manual soldering must only be done once.
- \* Care should be taken to avoid cooling at a rapid rate and ensure the peak temperature ramps down slowly.
- \* Customer is advised to use nitrogen reflow soldering as air flow process can cause optical degradation due to the heat and atmosphere of reflow soldering.
- \* Repairing should not be done after the LEDs have been soldered. When repairing is unavoidable, a double-head soldering iron should be used.  
It should be confirmed beforehand whether the characteristics of the LEDs will or will not be damaged by repairing.
- \* When soldering, avoid applying any stress to the LED package while heated.

# TAPE AND REEL DIMENSIONS

## テーピング部 Tape

Nxxx006x  
管理番号 No. STS-DA7-0168

(単位 Unit: mm)

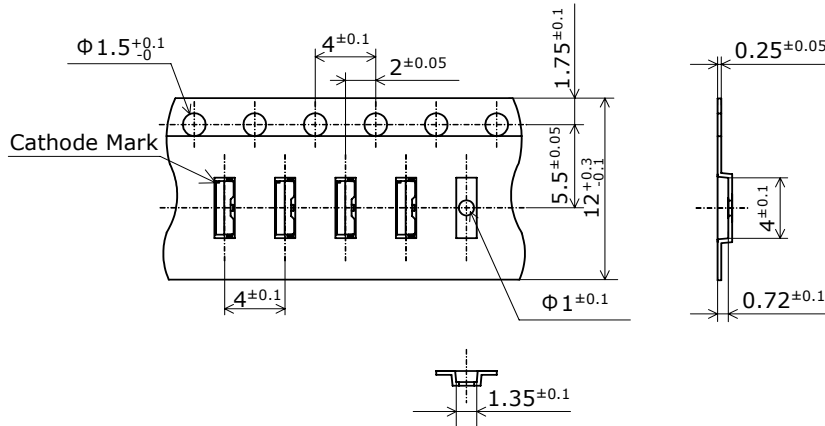

## トレーラ部/リーダ部 Trailer and Leader

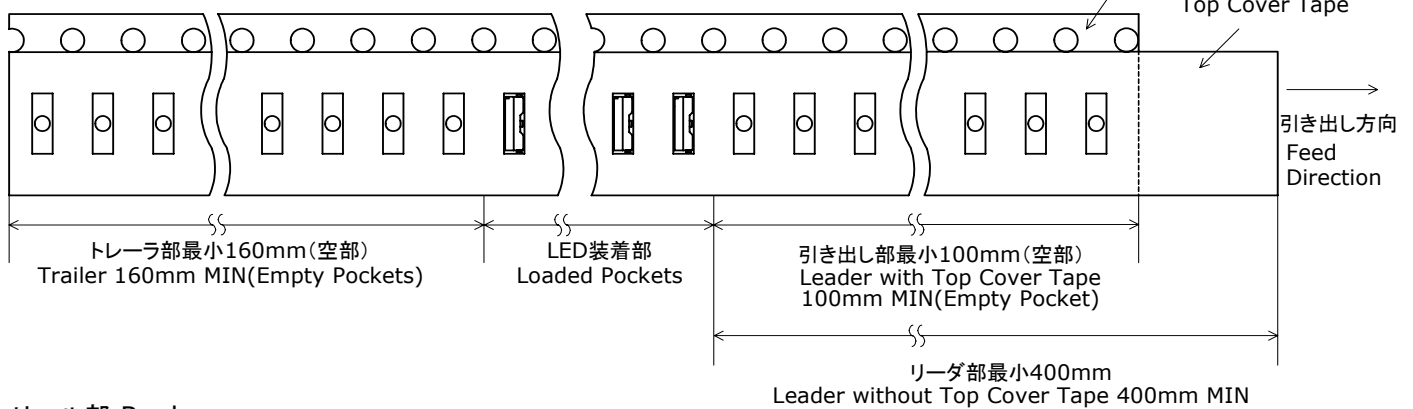

## リール部 Reel

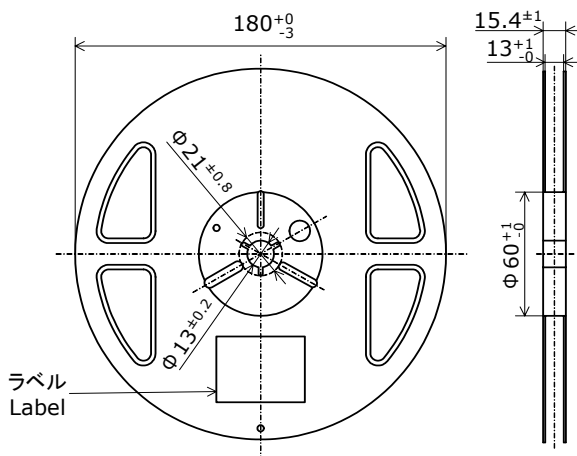

\* 数量は1リールにつき 5000個入りです。  
Quantity per reel=5000pcs

\* JIS C 0806電子部品テーピングに準拠しています。  
The tape packing method complies with JIS C 0806  
(Packaging of Electronic Components on Continuous Tapes).

PACKAGING - TAPE & REEL

シリカゲルとともにリールをアルミ防湿袋に入れ、熱シールにより封をします。  
The reel is placed in the moisture proof bag with a moisture absorbent material. The bag is heat sealed.

Nxxxxxxx  
管理番号 No. STS-DA7-0006A

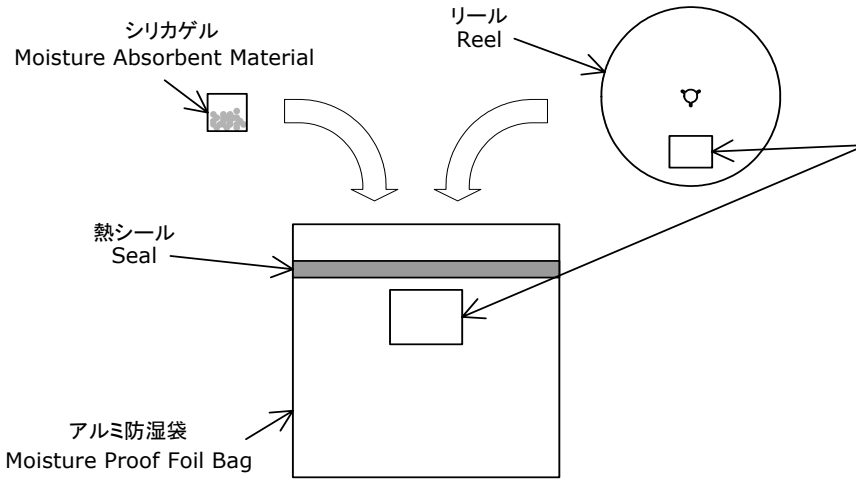

ラベル Label

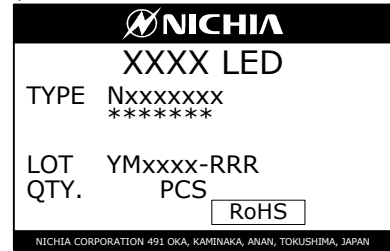

アルミ防湿袋を並べて入れ、ダンボールで仕切ります。  
The moisture proof foil bags are packed in a cardboard box with corrugated partition.

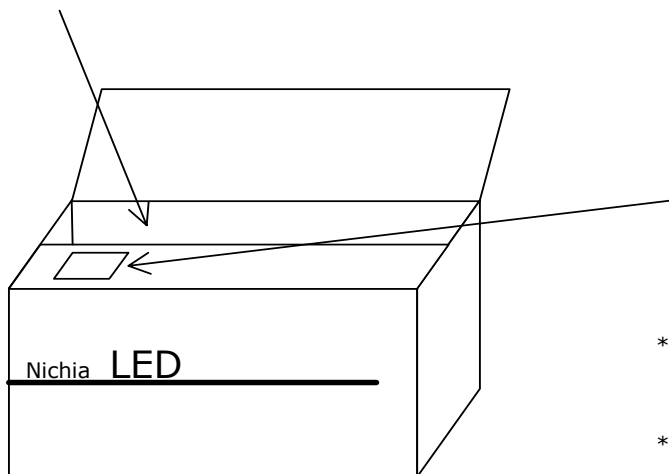

ラベル Label



- \* 客先型名を\*\*\*\*\*で示します。  
客先型名が設定されていない場合は空白です。  
\*\*\*\*\* is the customer part number.  
If not provided, it is not indicated on the label.
- \* ロット表記方法についてはロット番号の項を参照して下さい。  
For details, see "LOT NUMBERING SCHEME" in this document.
- \* ランク分けがない場合はランク表記はありません。  
The label does not have the RANK field for un-ranked products.

- \* 本製品はテーピングしたのち、輸送の衝撃から保護するためダンボールで梱包します。  
The products are taped and reeled, and then packed in moisture-proof bags.  
The moisture-proof bags are packed in cardboard boxes to prevent damage during shipment.
- \* 取り扱いに際して、落下させたり、強い衝撃を与えたりしますと、製品を損傷させる原因になりますので注意して下さい。  
Do not drop the cardboard box or expose it to shock. If the box falls, the products could be damaged.
- \* ダンボールには防水加工がされておきませんので、梱包箱が水に濡れないよう注意して下さい。  
The cardboard box is not water-resistant. Do not expose to water.
- \* 輸送、運搬に際して弊社よりの梱包状態あるいは同等の梱包を行って下さい。  
Customer is advised to pack the products in the original packaging or equivalent in transit.



## LOT NUMBERING SCHEME

Lot Number is presented by using the following alphanumeric code.

YMxxxx - RRR

Y - Year

| Year | Y |
|------|---|
| 2009 | 9 |
| 2010 | A |
| 2011 | B |
| 2012 | C |
| 2013 | D |
| 2014 | E |

M - Month

| Month | M | Month | M |
|-------|---|-------|---|
| 1     | 1 | 7     | 7 |
| 2     | 2 | 8     | 8 |
| 3     | 3 | 9     | 9 |
| 4     | 4 | 10    | A |
| 5     | 5 | 11    | B |
| 6     | 6 | 12    | C |

xxxx-Nichia's Product Number

RRR-Ranking by Color Coordinates, Ranking by Luminous Intensity

DERATING CHARACTERISTICS

NSSW006  
 管理番号 No. STS-DA7-0581

周囲温度-許容順電流特性  
 Ambient Temperature vs  
 Allowable Forward Current

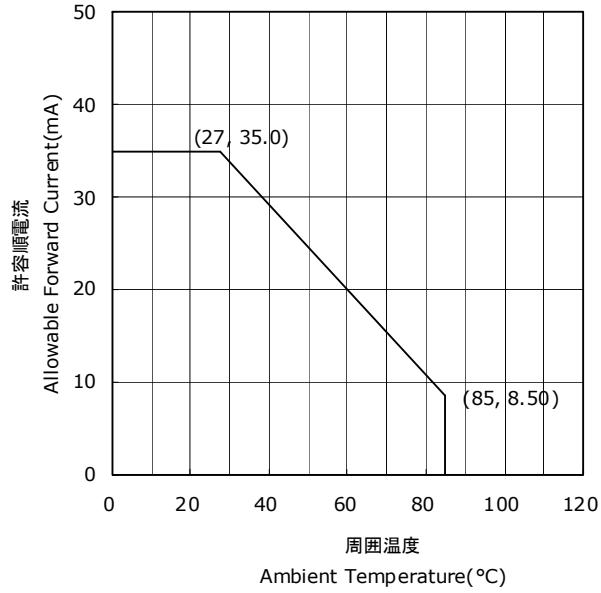

デューティー比-許容順電流特性  
 Duty Ratio vs  
 Allowable Forward Current

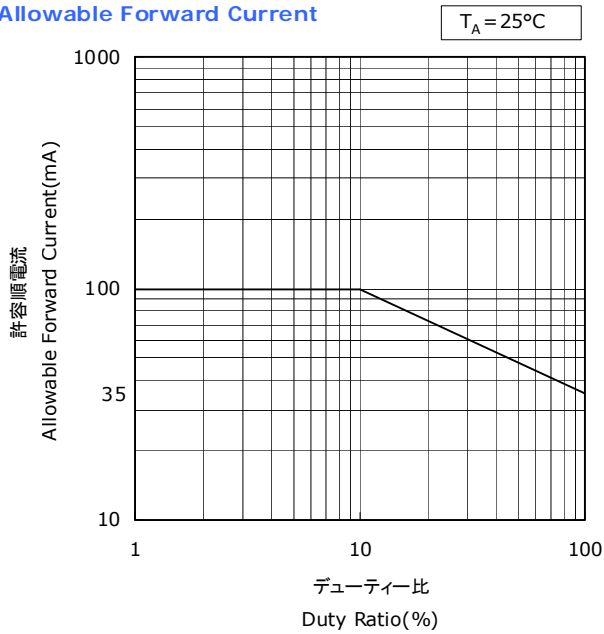

# OPTICAL CHARACTERISTICS

\* 本特性は参考です。  
All characteristics shown are for reference only and are not guaranteed.

NSSW006  
管理番号 No. STS-DA7-0820

## 発光スペクトル Spectrum

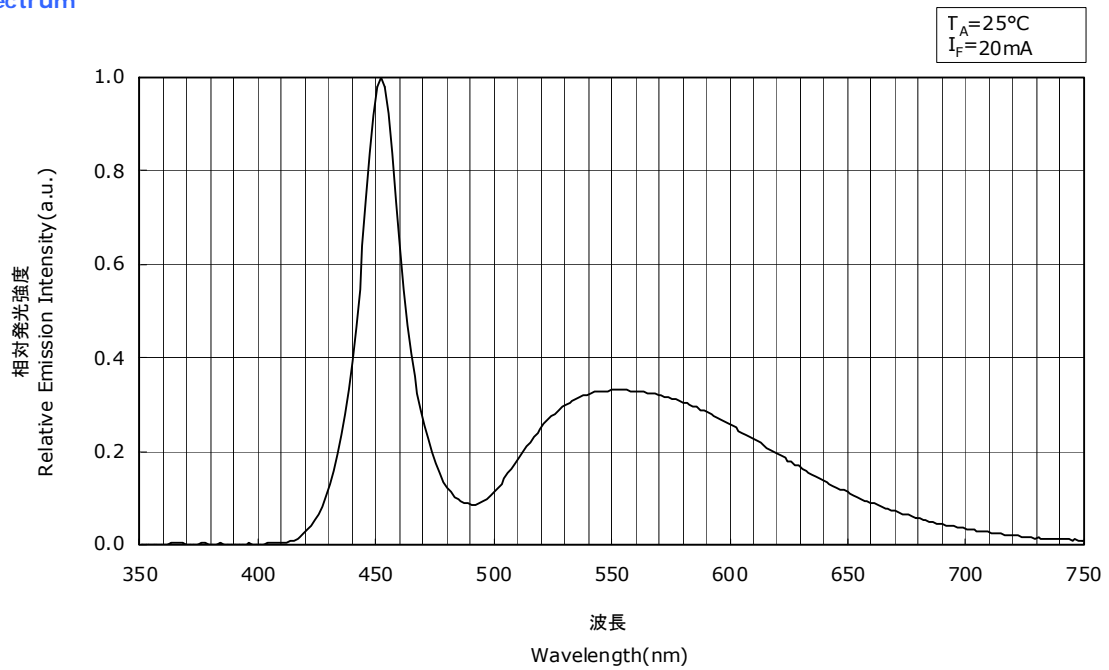

## 指向特性 Directivity

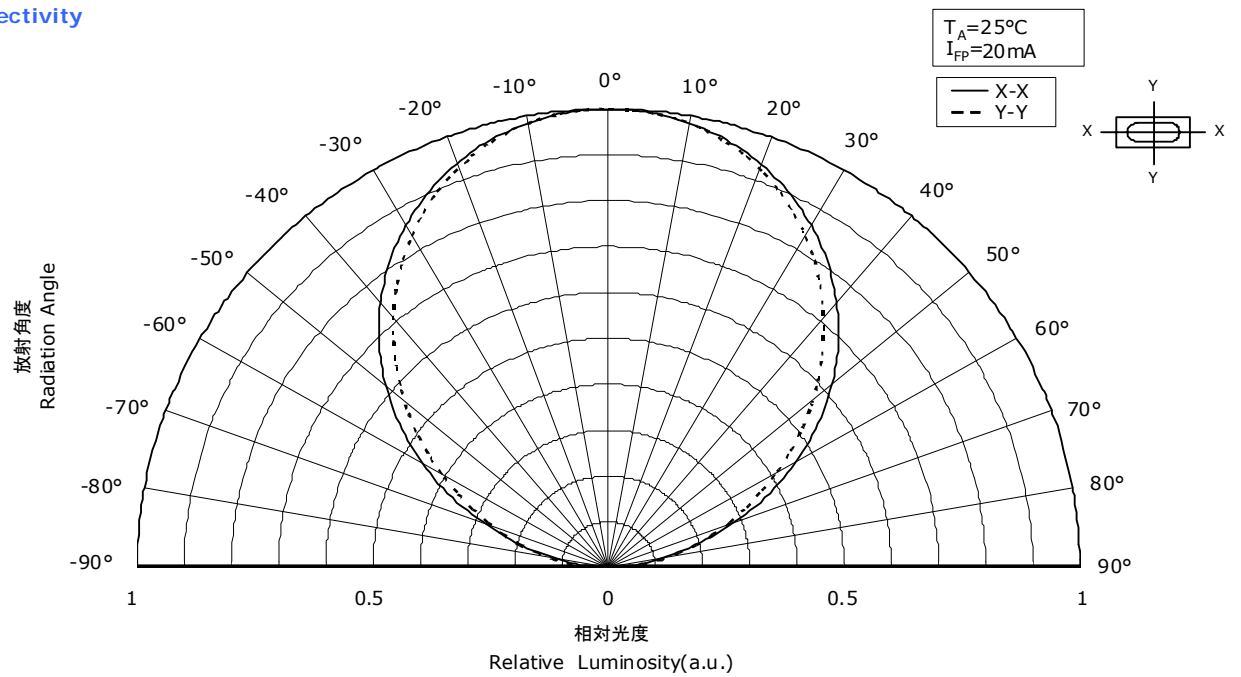

# FORWARD CURRENT CHARACTERISTICS / TEMPERATURE CHARACTERISTICS

\* 本特性は参考です。  
All characteristics shown are for reference only and are not guaranteed.

NSSW006  
管理番号 No. STS-DA7-0821

**順電圧-順電流特性**  
**Forward Voltage vs Forward Current**

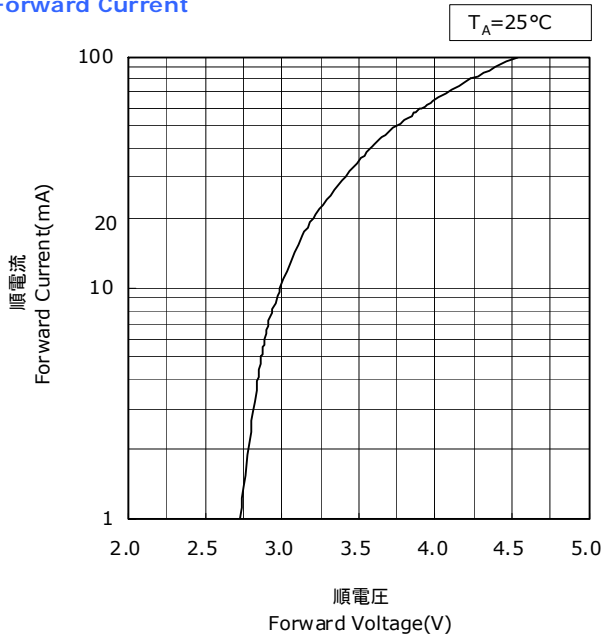

**周囲温度-順電圧特性**  
**Ambient Temperature vs Forward Voltage**

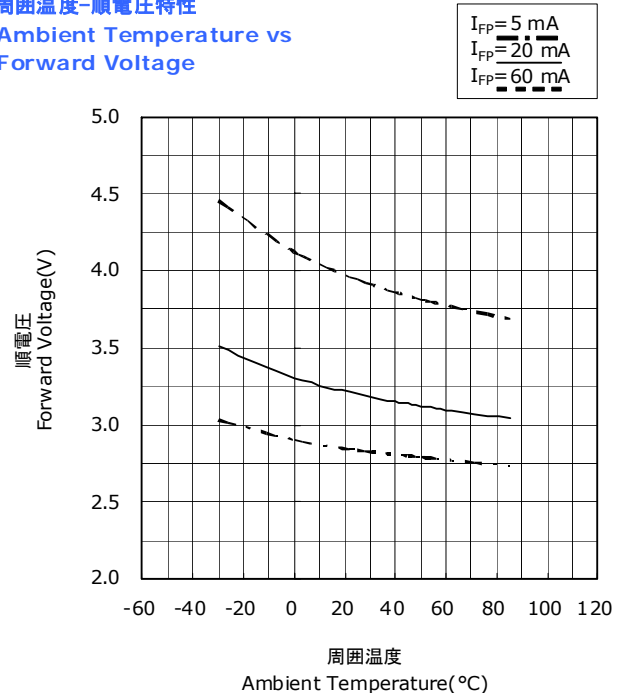

**順電流-相対光度特性**  
**Forward Current vs Relative Luminosity**

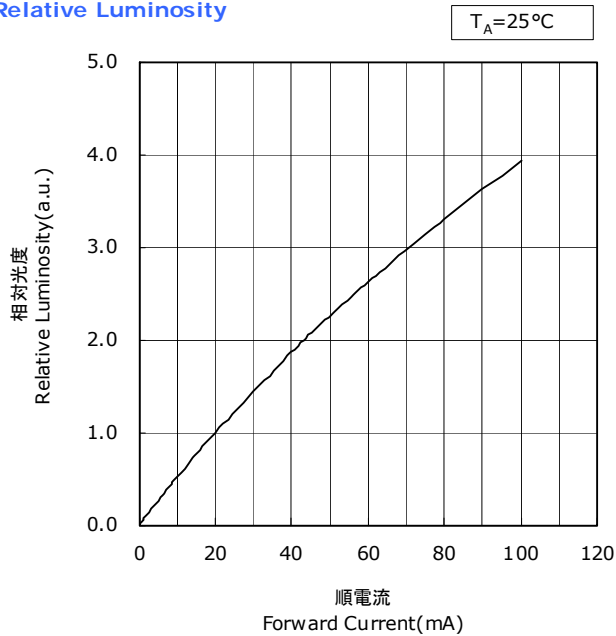

**周囲温度-相対光度特性**  
**Ambient Temperature vs Relative Luminosity**

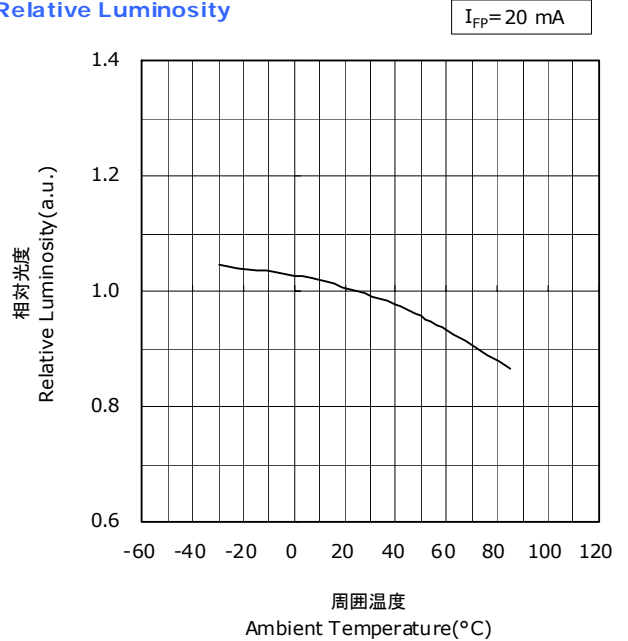

# FORWARD CURRENT CHARACTERISTICS / TEMPERATURE CHARACTERISTICS

\* 本特性は参考です。

All characteristics shown are for reference only and are not guaranteed.

NSSW006  
管理番号 No. STS-DA7-0822

順電流-色度特性  
Forward Current vs Chromaticity Coordinate

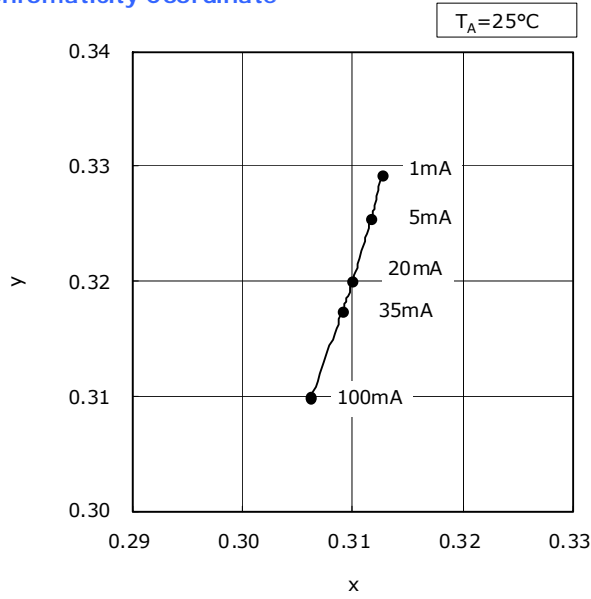

周囲温度-色度特性  
Ambient Temperature vs Chromaticity Coordinate

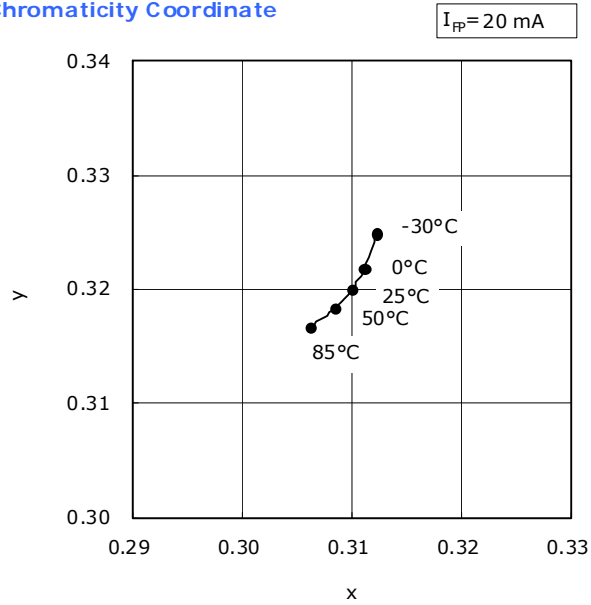

## RELIABILITY

## (1) Tests and Results

| Test  | Reference Standard     | Test Conditions   | Test Duration | Failure Criteria # | Units Failed/Tested |
|---|------------------------|---|---------------|--------------------|---------------------|
| Resistance to Soldering Heat (Reflow Soldering) | JEITA ED-4701 300 301  | $T_{\text{slid}}=260^{\circ}\text{C}$ , 10sec, 2reflows,<br>Precondition: $30^{\circ}\text{C}$ , 70%RH, 168hr                                     |               | #1                 | 0/50                |
| Solderability (Reflow Soldering)                | JEITA ED-4701 303 303A | $T_{\text{slid}}=245\pm 5^{\circ}\text{C}$ , 5sec,<br>Lead-free Solder(Sn-3.0Ag-0.5Cu)  |               | #2                 | 0/50                |
| Thermal Shock                                   | JEITA ED-4701 300 307  | $0^{\circ}\text{C}$ to $100^{\circ}\text{C}$ , 15sec dwell  | 20cycles      | #1                 | 0/50                |
| Temperature Cycle                               | JEITA ED-4701 100 105  | $-40^{\circ}\text{C}(30\text{min})\sim 25^{\circ}\text{C}(5\text{min})\sim 100^{\circ}\text{C}(30\text{min})\sim 25^{\circ}\text{C}(5\text{min})$ | 100cycles     | #1                 | 0/50                |
| Moisture Resistance (Cyclic)                    | JEITA ED-4701 200 203  | $25^{\circ}\text{C}\sim 65^{\circ}\text{C}\sim -10^{\circ}\text{C}$ , 90%RH,<br>24hr per cycle  | 10cycles      | #1                 | 0/50                |
| High Temperature Storage                        | JEITA ED-4701 200 201  | $T_A=100^{\circ}\text{C}$   | 1000hours     | #1                 | 0/50                |
| Temperature Humidity Storage                    | JEITA ED-4701 100 103  | $T_A=60^{\circ}\text{C}$ , RH=90%   | 1000hours     | #1                 | 0/50                |
| Low Temperature Storage                         | JEITA ED-4701 200 202  | $T_A=-40^{\circ}\text{C}$   | 1000hours     | #1                 | 0/50                |
| Room Temperature Operating Life Condition 1     |                        | $T_A=25^{\circ}\text{C}$ , $I_F=20\text{mA}$  | 1000hours     | #1                 | 0/50                |
| Room Temperature Operating Life Condition 2     |                        | $T_A=25^{\circ}\text{C}$ , $I_F=35\text{mA}$  | 500hours      | #1                 | 0/50                |
| High Temperature Operating Life                 |                        | $T_A=85^{\circ}\text{C}$ , $I_F=8.5\text{mA}$   | 1000hours     | #1                 | 0/50                |
| Temperature Humidity Operating Life             |                        | $60^{\circ}\text{C}$ , RH=90%, $I_F=15\text{mA}$  | 500hours      | #1                 | 0/50                |
| Low Temperature Operating Life                  |                        | $T_A=-30^{\circ}\text{C}$ , $I_F=20\text{mA}$   | 1000hours     | #1                 | 0/50                |
| Vibration                                       | JEITA ED-4701 400 403  | $200\text{m/s}^2$ , 100~2000~100Hz,<br>4cycles, 4min, each X, Y, Z  | 48minutes     | #1                 | 0/50                |
| Board Bending                                   | JEITA ED-4702B 003     | 1bend to a deflection of 3mm<br>for $5\pm 1\text{sec}$  |               | #1                 | 0/50                |
| Soldering Joint Shear Strength                  | JEITA ED-4702B 002 3   | 5N, $10\pm 1\text{sec}$   |               | #1                 | 0/50                |

## NOTES:

Measurements are performed after allowing the LEDs to return to room temperature.

## (2) Failure Criteria

| Criteria # | Items                       | Conditions        | Failure Criteria              |
|------------|-----------------------------|-------------------|-------------------------------|
| #1         | Forward Voltage( $V_F$ )    | $I_F=20\text{mA}$ | $> \text{U.S.L.} \times 1.1$  |
|            | Luminous Intensity( $I_V$ ) | $I_F=20\text{mA}$ | $< \text{L.S.L.} \times 0.7$  |
|            | Reverse Current( $I_R$ )    | $V_R=5\text{V}$   | $> \text{U.S.L.} \times 2.0$  |
| #2         | Solderability               | -                 | Less than 95% solder coverage |

U.S.L. : Upper Specification Limit    L.S.L. : Lower Specification Limit

## CAUTIONS

### (1) Storage

| Conditions |                             | Temperature                | Humidity              | Time                             |
|------------|-----------------------------|----------------------------|-----------------------|----------------------------------|
| Storage    | Before Opening Aluminum Bag | $\leq 30^{\circ}\text{C}$  | $\leq 90\% \text{RH}$ | Within 1 Year from Delivery Date |
|            | After Opening Aluminum Bag  | $\leq 30^{\circ}\text{C}$  | $\leq 70\% \text{RH}$ | $\leq 168 \text{hours}$          |
| Baking     |                             | $65 \pm 5^{\circ}\text{C}$ | -                     | $\geq 24 \text{hours}$           |

- This product is compliant to JEDEC MSL 3 or equivalent. See IPC/JEDEC STD-020 for the details of the moisture sensitivity levels.
- Interface delamination can occur due to vaporization and expansion of absorbed moisture in the LED packages caused by soldering heat, which may result in degradation in optical performance.  
To minimize moisture absorption into the products during the transportation and storage, the products are packed in a moisture-proof aluminum bag. Desiccants (silica gel) inside the packing turn from blue to red as it absorbs moisture.
- After opening the moisture-proof aluminum bag, the products should be completed soldering process within the range of the conditions above. If unused LEDs remain, they should be stored with desiccants (silica gel) in hermetically sealed container. Nichia recommends using the original moisture-proof bag for storage.
- After the "Period After Opening" specified above, or if the desiccants (silica gel) are no longer blue, the products need to be baked. Note that baking must only be done once.
- Customer is advised to keep the LEDs in an airtight container when not in use as exposure to a corrosive environment might cause the plated metal parts of the product to tarnish, which might lead to difficulties in soldering and/or adverse effects on optical characteristics. It is also recommended to return the LEDs to the original moisture proof bag and seal the moisture proof bag again.
- After assembly and during use, silver plating can be affected by the corrosive gases emitted by components and materials in close proximity of the LEDs within an end product, and the gases entering into the product from the external atmosphere. The above should be taken into consideration when designing. After assembly and during use, silver plating can be affected by the corrosive gases emitted by components and materials in close proximity of the LEDs within an end product, and the gases entering into the product from the external atmosphere. The above should be taken into consideration when designing. Resin materials, in particular, may contain substances which affects on silver plating, such as halogen.
- To avoid condensation, the products must not be stored in the areas where temperature and humidity fluctuate greatly.

### (2) Directions for Use

- In designing a circuit, the current through each LED must not exceed the Absolute Maximum Rating specified for each LED. It is recommended to use Circuit B which regulates the current flowing through each LED. In the meanwhile, when driving LEDs with a constant voltage in Circuit A, the current through the LEDs may vary due to the variation in Forward Voltage characteristics of the LEDs.

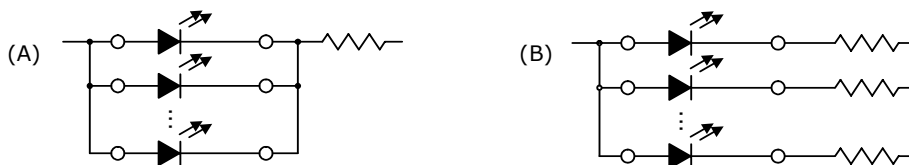

- This product should be operated in forward bias. A driving circuit must be designed so that the product is not subjected to either forward or reverse voltage while it is off. In particular, if a reverse voltage is continuously applied to the product, such operation can cause migration resulting in LED damage.
- For stabilizing the LED characteristics, it is recommended to operate at 10% of the rated current or higher.
- Care must be taken to ensure that the reverse voltage will not exceed the Absolute Maximum Rating when using the LEDs with matrix drive.
- For outdoor use, necessary measures should be taken to prevent water, moisture and salt air damage.

### (3) Handling Precautions

- When handling the product, do not touch it directly with bare hands as it may contaminate the surface and affect on optical characteristics. In the worst cases, excessive force to the product might result in catastrophic failure due to package damage and/or wire breakage.
- When handling the product with tweezers, make sure that excessive force is not applied to the resin portion of the product. Failure to comply can cause the resin portion of the product to be cut, chipped, delaminated and/or deformed, and wire to be broken, and thus resulting in catastrophic failure.
- If the product is dropped, it might be damaged.
- Do not stack assembled PCBs together. Failure to comply can cause the resin portion of the product to be cut, chipped, delaminated and/or deformed, and wire to be broken, and thus resulting in catastrophic failure.

### (4) Design Consideration

- PCB warpage after mounting the products onto a PCB can cause the package to break.  
The LEDs should be placed so as to minimize the stress on the LEDs due to PCB bow and twist.
- The position and orientation of the LEDs affect how much mechanical stress is exerted on the LEDs placed near the score lines.  
The LEDs should be placed so as to minimize the stress on the LEDs due to board flexing.
- Board separation must be performed using special jigs, not with hands.

### (5) Electrostatic Discharge (ESD)

- The products are sensitive to static electricity or surge voltage. An ESD event may damage its die or reduce its reliability performance. When handling the products, measures against electro static discharge, including the followings, are strongly recommended.
  - Eliminating the charge;
    - Wrist strap, ESD footwear and garments, ESD floors
    - Grounding the equipment and tools at workstation
    - ESD table/shelf mat (conductive materials)
- Proper grounding techniques are required for all devices, equipment and machinery used in the assembly of the products.  
Also note that surge protection should be considered in the design of customer products.
- If tools or equipment contain insulating materials, such as glass or plastic, proper measures against electro static discharge, including the followings, are strongly recommended.
  - Dissipating the charge with conductive materials
  - Preventing the charge generation with moisture
  - Neutralizing the charge with ionizers
- When performing the characteristics inspection of the LEDs in your application, customer is advised to check on the LEDs whether or not they are damaged by ESD. Such damage can be detected during forward voltage measurement or light up test at low current. (the recommended current is 1mA or lower)
- ESD-damaged LEDs may have an increased leakage current, current flow at low voltage, or no longer light up at low current.  
Failure Criteria:  $V_F < 2.0V$  at  $I_F = 0.5mA$

### (6) Thermal Management

- Thermal management is an important factor when designing your product by using the LEDs.  
The rise in LED die temperature can be affected by PCB thermal resistance or/and LED spacing as mounted on the board.  
Customer is advised to design the product to ensure that the LED die temperature does not exceed the required maximum Junction Temperature ( $T_J$ ).
- Drive current should be determined for the surrounding ambient temperature ( $T_A$ ) to dissipate the heat from the product.

### (7) Cleaning

- If required, isopropyl alcohol (IPA) should be used. Other solvents may cause premature failure to the LEDs due to the damage to the resin portion. The effects of such solvents should be verified prior to use.  
In addition, the use of CFCs such as Freon is heavily regulated.
- Ultrasonic cleaning is not recommended for the LEDs since it may adversely effect on the LEDs by the ultrasonic power and LED assembled condition.  
If it is unavoidable, customer is advised to check prior to use that the cleaning will not damage the LEDs.



## (8) Eye Safety

- The International Electrical Commission (IEC) published in 2006, IEC 62471:2006 Photobiological safety of lamps and lamp systems which includes LEDs within its scope. Meanwhile LEDs were removed from the scope of the IEC 60825-1:2007 laser safety standard, the 2001 edition of which included LED sources within its scope. However, keep it mind that some countries and regions have adopted standards based on the IEC laser safety standard IEC 60825-1:2001 which includes LEDs within its scope. Following IEC 62471:2006, most of Nichia LEDs can be classified as belonging to either Exempt Group or Risk Group 1. Especially a high-power LED, that emits light containing blue wavelengths, may be in Risk Group 2. Great care should be taken when viewing directly the LED driven at high current or the LED with optical instruments, which greatly increase the hazard to your eyes.
- Viewing a flashing light may cause eye discomfort. When incorporating the LED into your product, precaution should be taken to avoid adverse effect on human body caused by the light stimulus.

## (9) Others

- The LEDs described in this brochure are intended to be used for ordinary electronic equipment (such as office equipment, communications equipment, measurement instruments and household appliances). Consult Nichia's sales staff in advance for information on the applications in which exceptional quality and reliability are required, particularly when the failure or malfunction of the LEDs may directly jeopardize life or health (such as for airplanes, aerospace, submersible repeaters, nuclear reactor control system, automobiles, traffic control equipment, life support systems and safety devices).
- The customer shall not reverse engineer by disassembling or analysis of the LEDs without having prior written consent from Nichia. When defective LEDs are found, the customer shall inform Nichia directly before disassembling or analysis.
- Customer and Nichia shall agree the official specification of supplied products prior to the start of a customer's volume production.
- The appearance and specifications of the product may be modified for improvement without notice.