

# PRODUCT SPECIFICATION

Model No.: FYLS-1206BUYC

## Features:

- SMD Type
- Size (mm):3.2\*1.6\*1.4
- Emitting Color:Yellow
- SMT package
- Suitable for all SMT assembly and soldering method
- Pb-free Reflow soldering application
- RoHS Compliant



## Applications:

- Light Strips
- LCD Backlight
- Decorative lighting
- Indicators
- Interior automotive
- Illuminations
- Mobile Phones



CUSTOMER APPROVED SIGNATURES	APPROVED BY	CHECKED BY	PREPARED BY

NINGBO FORYARD OPTOELECTRONICS CO.,LTD

Add:NO.115 Qixin Road Ningbo Zhejiang China

Zip:315051

Tel: 0086-574-87933652 87927870 87922206

Fax: 0086-574-87927917

E-mail:Sales@foryard.com (General)

[Http://www.foryard.com](http://www.foryard.com)

[Http://www.foryard.com](http://www.foryard.com)

Page : 1/8

Model No.: FYLS-1206BUYC

■ Mechanical Dimensions

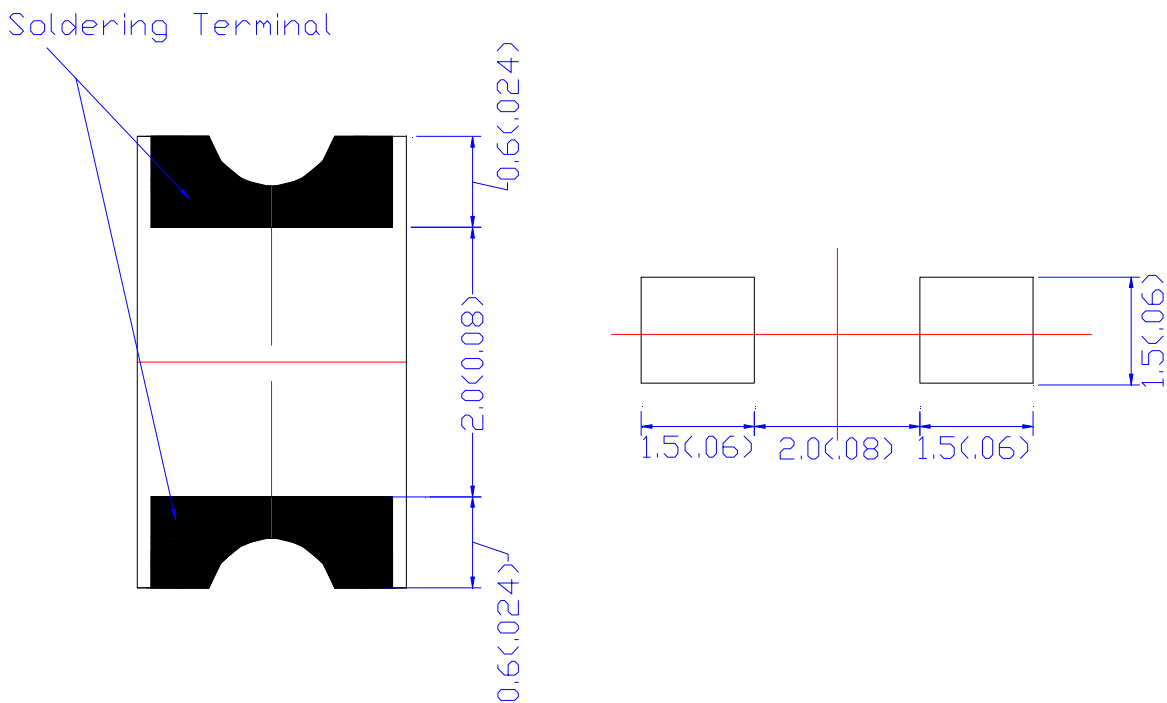
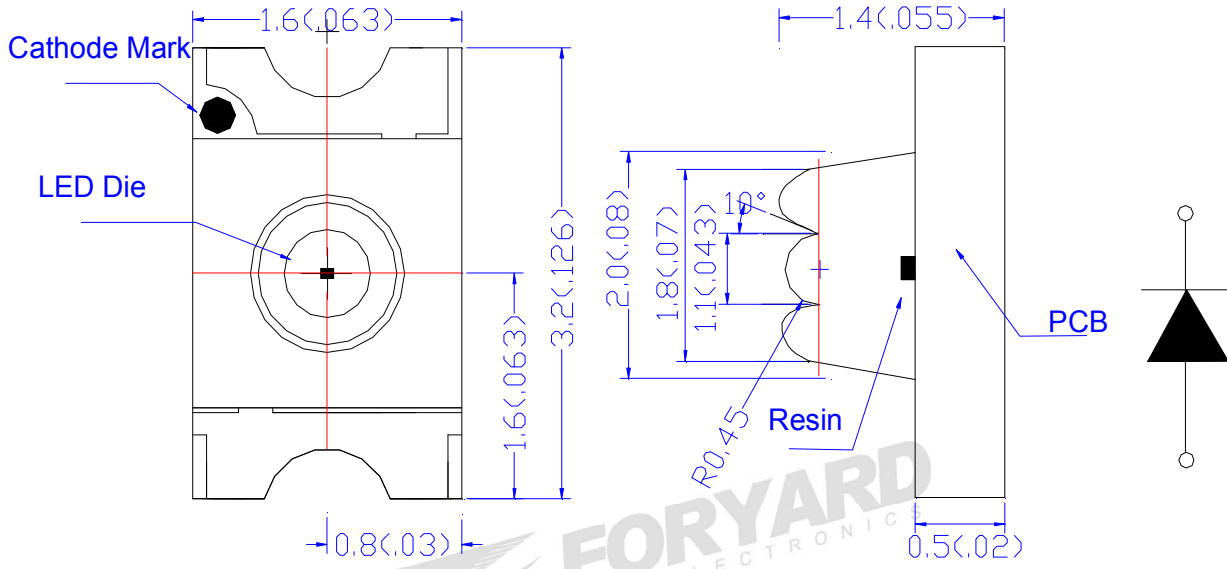

Notes:

1. Dimension in millimeter [inch], tolerance is  $\pm 0.25$  [.010].
2. The specifications, characteristics and technical data described in the datasheet are subject to change without prior notice.

Model No.: FYLS-1206BUYC

■ Absolute Maximum Ratings(Ta=25° C)

Items	Symbol	Absolute maximum Rating	Unit
Forward Current(DC)	IF	30	mA
Peak Forward Current*	IFP	100	mA
Power Dissipation	PD	78	Mw
Operation Temperature	Topr	-40° C~+85° C	°C
Storage Temperature	Tstg	-40°C~+100°C	°C
Reverse Voltage	VR	5	V
Soldering Temperature	Tsol	Reflow Soldering:250°C/5sec	

\*Pulse width  $\leq$  1msec duty  $\leq$  1/10

■ Typical Electrical &Optical Charcteristics(Ta=25°C)

Items	Symbol	Condition	Min.	Typ.	Max	Unit
Forward Voltage	VF	IF = 20mA	1.80	---	2.60	V
Reverse Current	IR	VR = 5V			10	uA
Peak Emission Wavelength	$\lambda_p$	IF = 20mA		593		nm
Dominant Wavelength	$\lambda_D$	IF = 20mA		592		nm
Luminous Intensity	IV	IF = 20mA		270		mcd
50% Power Angle	2 $\theta_{1/2}$	IF = 20mA	---	30	---	Deg

■ Material

Item	Reflector	Wire	Encapsulate	Chip
Material	/	Gold	Silicone	AlGaInP

Note:

- 1.Luminous Intensity is based on the Foryard standards.
- 2.Pay attention about static for InGaN

**Model No.: FYLS-1206BUYC**

**Typical Eletrical/Optical Characteristics Curves(Ta=25° C Unless Otherwise Noted)**

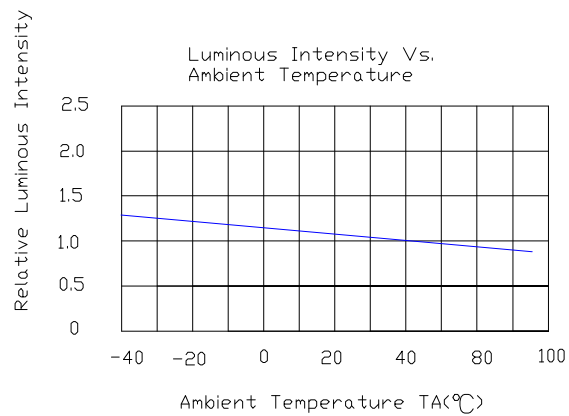
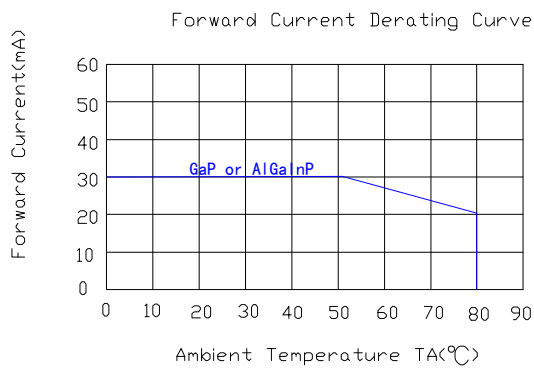
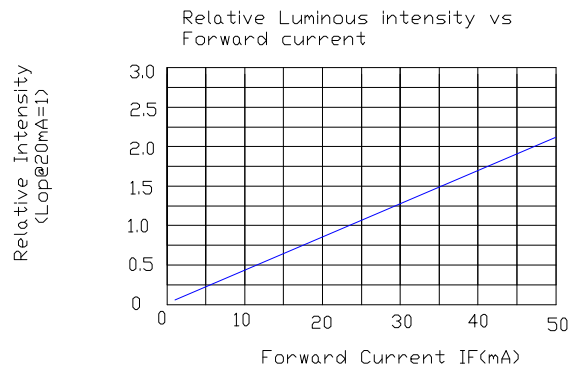
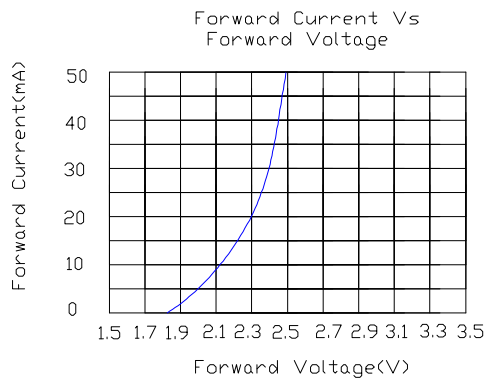
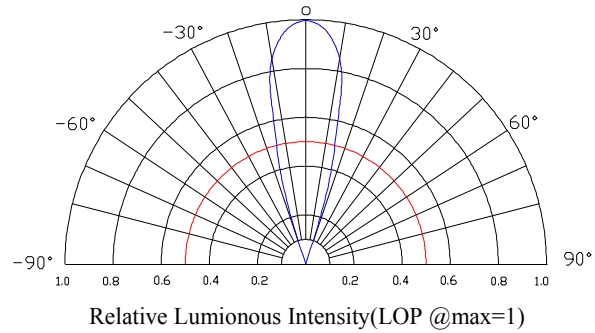
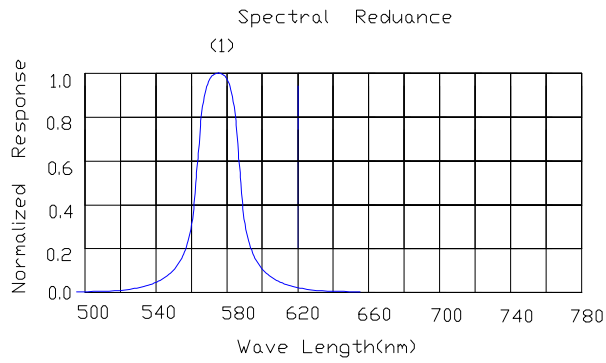

Model No.: FYLS-1206BUYC

■ Packing Diagram

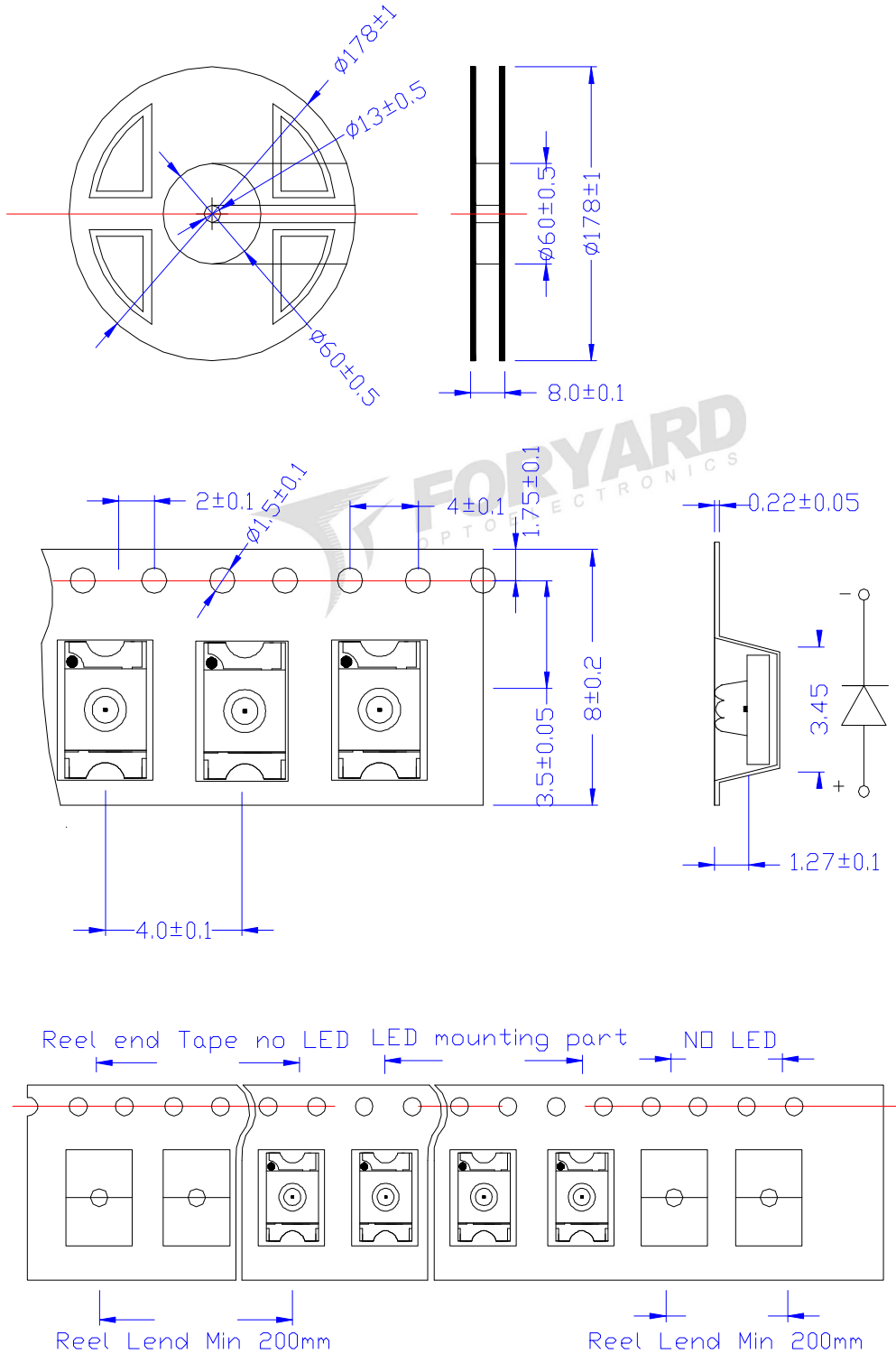

Note: The specifications are subject to change without notice. Please contact us for updated information.

**Model No.: FYLS-1206BUYC**

**■ Packing Diagram**

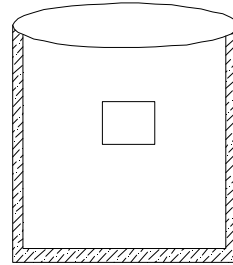
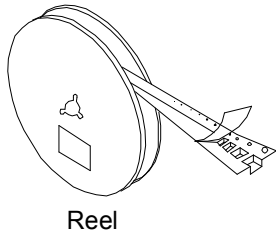

1206B 3000/Reel

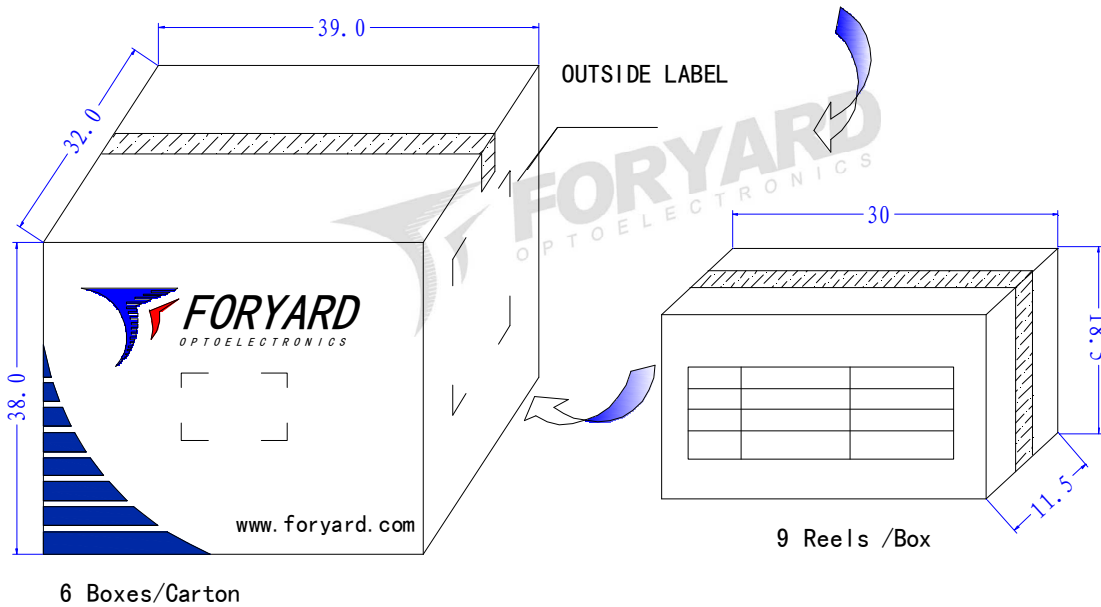

OUTSIDE LABEL

Note: The specifications are subject to change without notice. Please contact us for updated information.

**Model No.: FYLS-1206BUYC**

**■ Precautions for use:**

**1. Storage**

To prevent moisture absorption into SMD LEDs during the transportation and storage , the LEDs are packed in a moisture-barrier bag. Desiccants and a humidity indicator are packed together with the LEDs as secondary protection

The shelf life of LEDs stored in the original sealed bag at <math> < 40^{\circ}\text{C}</math> and <math> < 90\% \text{ RH}</math> is 12 months. Baking is required if the shelf life has expired

Before opening the packaging , check for air leaks in the bag.

After the bag is opened, the SMD LEDs must be stored at <math> < 30^{\circ}\text{C}</math> and <math> < 60\% \text{ RH}</math>. Under these conditions, SMD LEDs must be used within 24 hours. If the LEDs are not within 24 hours after removal from the bag , baking is required Take the material out of the packaging bag before baking. Do not open the oven door frequently during the baking process.

**2. Soldering**

**(1) Manual soldering with a soldering Iron**

Use a soldering iron of less than 25 watts is recommended . The iron temperature must be kept below <math> 315^{\circ}\text{C}</math> And soldering time no more than 2 seconds.

The epoxy resin of an SMD LED should not contact the tip of the soldering iron.

No mechanical stress should be exerted on the resin portion of an SMD LED during soldering.

Handling of an SMD LED should be done only when the package has been cooled down to below <math> 40^{\circ}\text{C}</math>

**(2)Reflow soldering**

**Temperature profile**

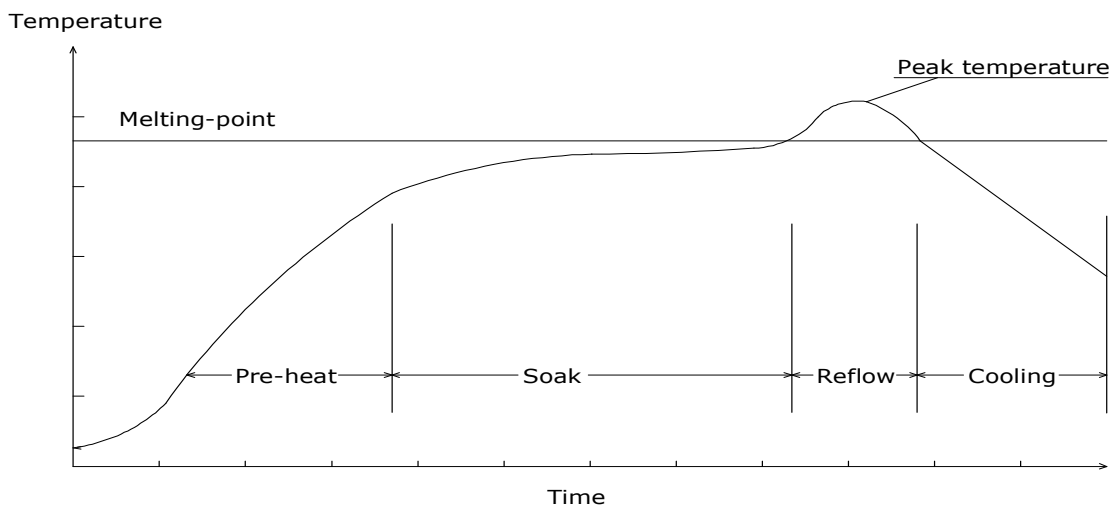

**Model No.: FYLS-1206BUYC**

Solder=Sn63-Pb37	Solder= Pb-Free
Average ramp-up rate:4°C/sec.max	Average ramp-up rate:4°C/sec.max
Peak preheat temperature:100-150°C	Peak preheat temperature:100-150°C
preheat time:100seconds.max	preheat time:100seconds.max
ramp-down rate:6°C/sec.max	ramp-down rate:6°C/sec.max
Peak temperature:230°C	Peak temperature:250°C
Time within 5°C of actual peak temperature=10 sec. max	Time within 5°C of actual peak temperature=10 sec. max
Duration above 183°C is 80 sec. max	Duration above 217°C is 80 sec. max

SMD LED should not be modified after soldering. If modification cannot be avoided, the modification must be pre-qualified to avoid damage to the SMD LEDs.

Reflow soldering should not be done more than one time

No stress should be exerted on the package during soldering.

(3) Recommend Soldering pad design(unit=mm)

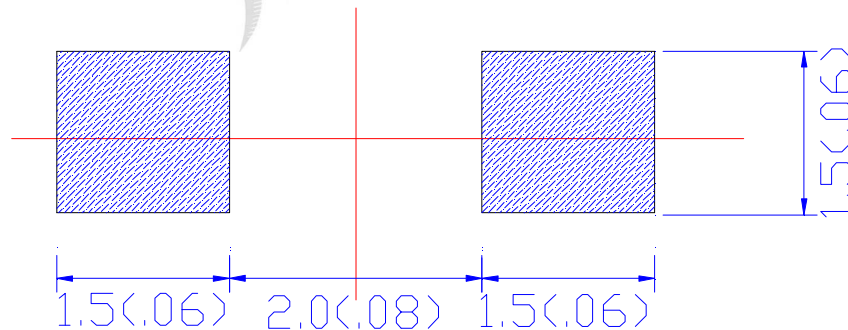

3. Static Electricity

Static Electricity and surge voltage damage the LEDs. So it is recommended that an ESD wrist band, ESD shoe strap or an anti-electrostatic glove be used when handling the LEDs.

All devices, equipment and machinery must be properly grounded

4. Others

Reverse voltage should not exceed the absolute maximum rating on the data sheet. The colour of the LEDs is changed slightly an operating current and thermal.

This device should not be used in any type of fluid such as water, oil, organic solvent and etc

When washing is required, IPA (Isopropyl Alcohol) should be used.

The influence of ultrasonic cleaning on the leds depends on factors such as ultrasonic power and the way.

High-brightness LED light may injure human eyes. Avoid looking directly into lighted LED

The appearance and specifications of the product may be modified for improvement without notice.