

Model. No.	FYL-1804PGC1A
Rev.	A

# PRODUCT SPECIFICATION

**Model No.: FYL-1804PGC1A**

Descriptions:
■ Dice material: InGaN.
■ Emitting Color: Super bright Pure Green.
■ Device Outline: $\Phi$ 1.8mm nipple type.
■ Lens Type: Water clear.



CUSTOMER APPROVED SIGNATURES	APPROVED BY	CHECKED BY	PREPARED BY

**NINGBO FORYARD OPTOELECTRONICS CO.,LTD.**

**Add:** NO.115 Qixin Road Ningbo Zhejiang China

**Zip:** 315051

**Tel:** 0086-574-87933652 87927870 87922206

**Fax:** 0086-574-87927917

**E-mail:** Sales@foryard.com (General)

[Http://www.foryard.com](http://www.foryard.com)

[Http://www.foryard.com](http://www.foryard.com)

Model. No.	FYL-1804PGC1A
Rev.	A

## ■ Features

1. Low power consumption.
2. High efficiency.
3. General purpose leads.
4. High intensity.
5. RoHs compliant.

## ■ Package configuration

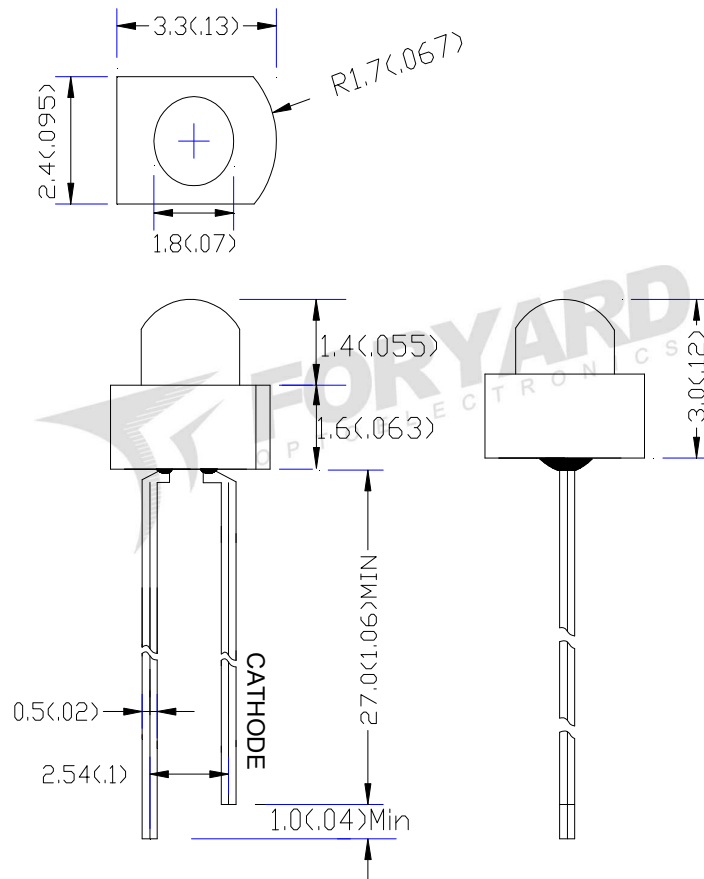

### Notes:

1. All dimensions are millimeters (inches)
2. Tolerance is  $\pm 0.25\text{mm} (.010\text{'})$  unless otherwise noted.
3. The specifications, characteristics and technical data described in the datasheet are subject to change without prior notice.

■ Absolute maximum ratings( $T_a=25\text{ }^\circ\text{C}$ )

Parameter	MAX.	Unit
Power Dissipation	90	mW
Peak Forward Current (1/10 Duty Cycle, 0.1ms Pulse Width)	100	mA
Continuous Forward Current	25	mA
Derating Linear From 50°C	0.4	mA/°C
Reverse Voltage	5	V
Operating Temperature Range	-40°C to +85°C	
Storage Temperature Range	-40°C to +100°C	
Lead Soldering Temperature[4mm(.157") From Body]	260°C for 5 Seconds	

■ Electrical and optical characteristics( $T_a=25\text{ }^\circ\text{C}$ )

Parameter	Symbol	Min.	Typ.	Max.	Unit	Test Condition
Luminous Intensity	$I_v$	-	22000	-	mcd	$I_F=20\text{mA}$
Viewing Angle	$2\theta_{1/2}$	-	20	-	Deg	
Peak Emission Wavelength	$\lambda_p$	-	520	-	nm	
Dominant Wavelength	$\lambda_d$	517	522	527	nm	
Spectral Line Half-Width	$\Delta\lambda$	-	30	-	nm	
Forward Voltage	$V_F$	2.8	3.2	3.6	V	
Reverse Current	$I_R$			10	$\mu\text{A}$	$V_R=5\text{V}$

## ■ Typical Electrical Characteristics Curves

(25 °c Ambient Temperature Unless Otherwise Noted)

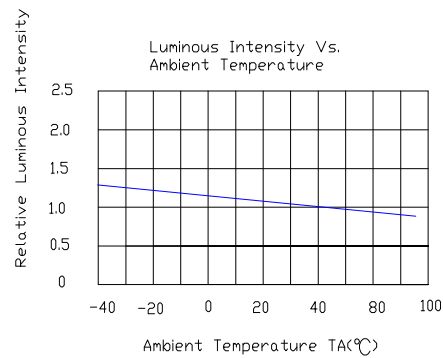
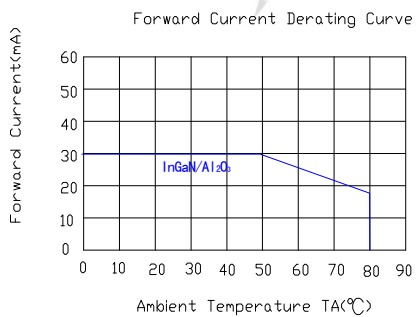
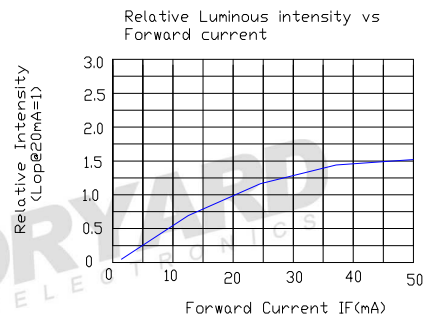
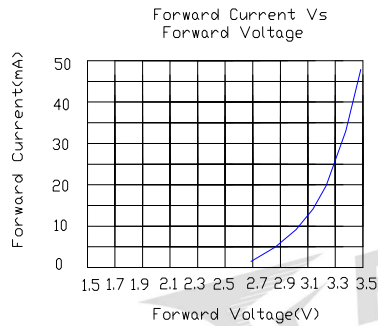
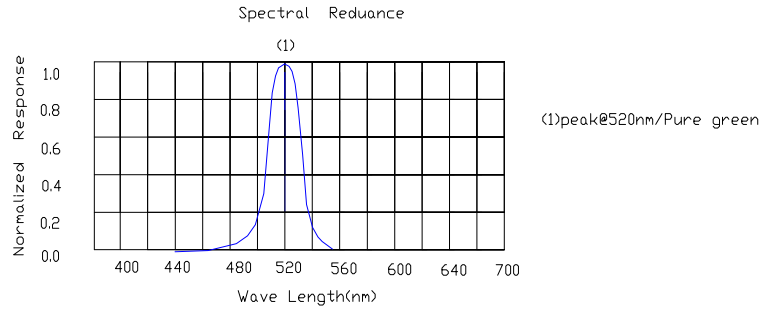

## Radiation pattern.

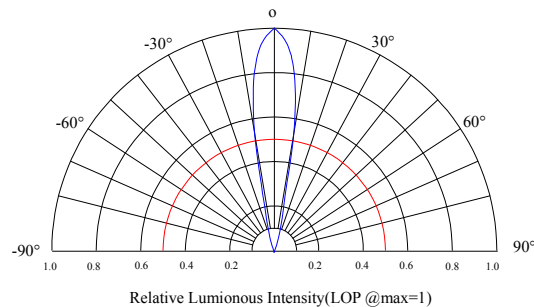

Model. No.	FYL-1804PGC1A
Rev.	A

■ LAMP PACKING.

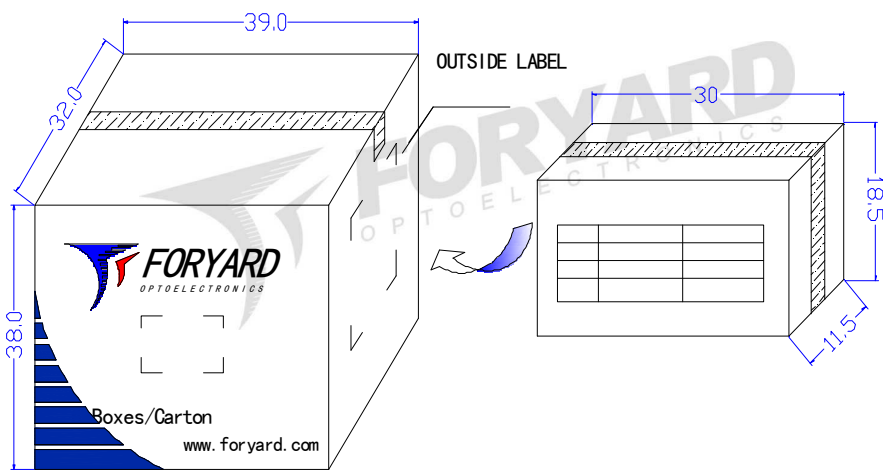
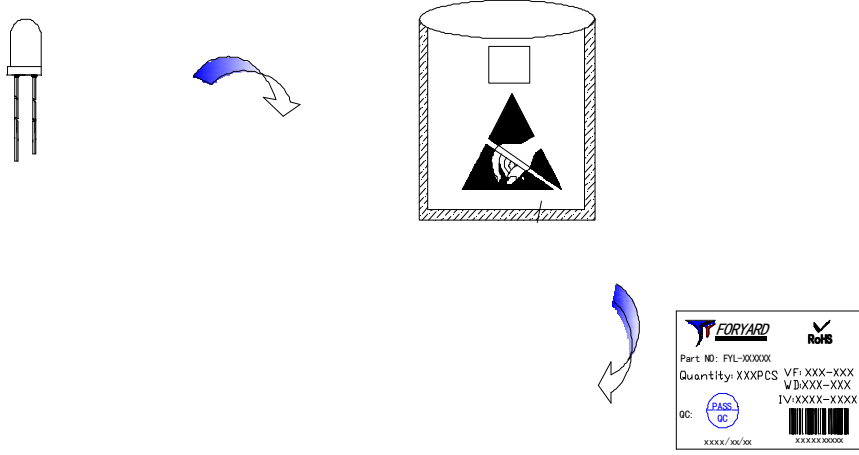

OUTSIDE LABEL