

Model. No.	FYL-5044PGC1E
Rev.	A

# PRODUCT SPECIFICATION

**Model No.: FYL-5044PGC1E**

Descriptions:
■ Dice material: InGaN.
■ Emitting Color: Super bright Pure Green.
■ Device Outline: Φ5mm cylinder type.
■ Lens Type: Water clear.



CUSTOMER APPROVED SIGNATURES	APPROVED BY	CHECKED BY	PREPARED BY

**NINGBO FORYARD OPTOELECTRONICS CO.,LTD.**

**Add:** NO.115 Qixin Road Ningbo Zhejiang China

**Zip:** 315051

**Tel:** 0086-574-87933652 87927870 87922206

**Fax:** 0086-574-87927917

**E-mail:** Sales@foryard.com (General)

[Http://www.foryard.com](http://www.foryard.com)

[Http://www.foryard.com](http://www.foryard.com)



■ Absolute maximum ratings( $T_a=25\text{ }^\circ\text{C}$ )

Parameter	MAX.	Unit
Power Dissipation	90	mW
Peak Forward Current (1/10 Duty Cycle, 0.1ms Pulse Width)	100	mA
Continuous Forward Current	25	mA
Derating Linear From 50°C	0.4	mA/°C
Reverse Voltage	5	V
Operating Temperature Range	-40°C to +85°C	
Storage Temperature Range	-40°C to +100°C	
Lead Soldering Temperature[4mm(.157") From Body]	260°C for 5 Seconds	

■ Electrical and optical characteristics( $T_a=25\text{ }^\circ\text{C}$ )

Parameter	Symbol	Min.	Typ.	Max.	Unit	Test Condition
Luminous Intensity	$I_v$	-	2000	-	mcd	$I_F=20\text{mA}$
Viewing Angle	$2\theta_{1/2}$	-	90	-	Deg	
Peak Emission Wavelength	$\lambda_p$	-	520	-	nm	
Dominant Wavelength	$\lambda_d$	517	522	527	nm	
Spectral Line Half-Width	$\Delta\lambda$	-	30	-	nm	
Forward Voltage	$V_F$	2.8	3.2	3.6	V	
Reverse Current	$I_R$			10	$\mu\text{A}$	$V_R=5\text{V}$

## ■ Typical Electrical Characteristics Curves

(25 °c Ambient Temperature Unless Otherwise Noted)

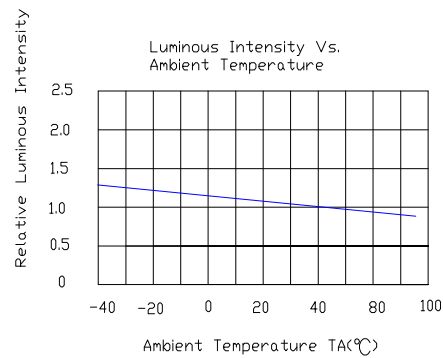
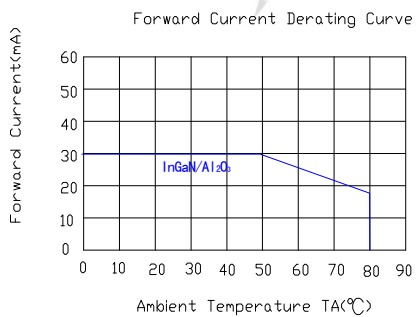
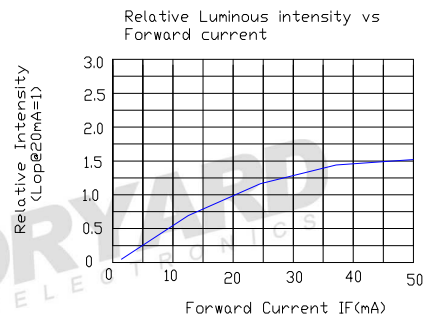
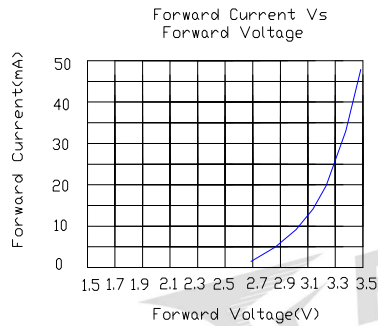
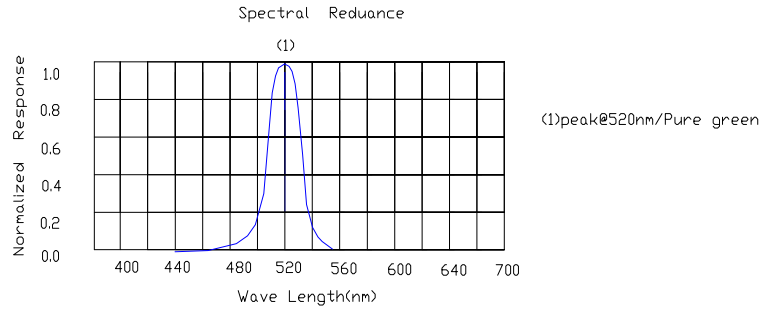

## Radiation pattern.

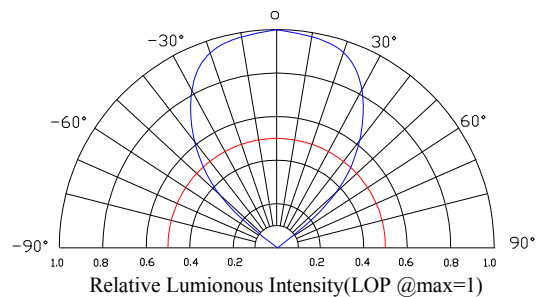

<b>Model. No.</b>	FYL-5044PGC1E
<b>Rev.</b>	A

■ LAMP PACKING.

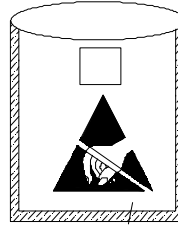
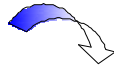

5mm 500PCS/Polybag

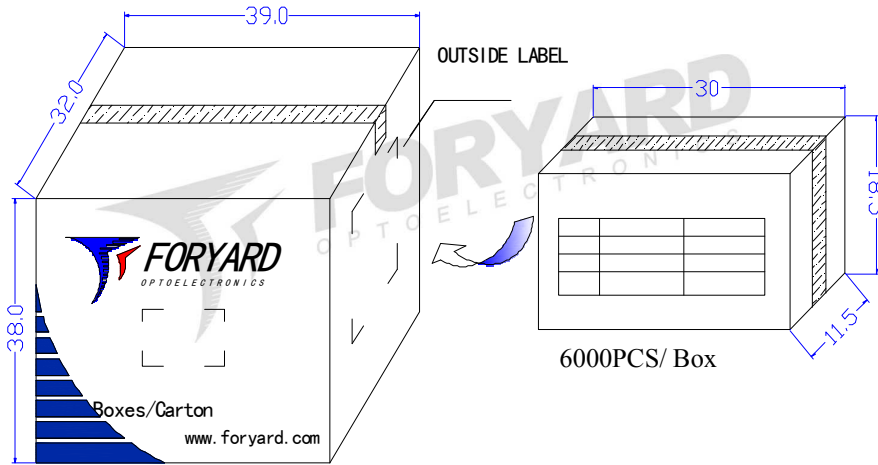
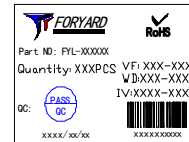

36000PCS/ Carton

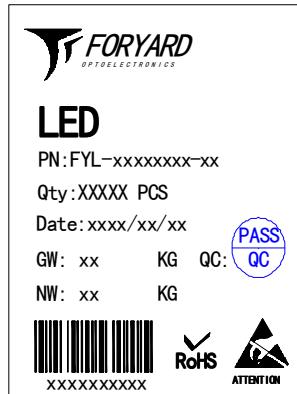

OUTSIDE LABEL