

Model. No.	FYL-4012UGC1B
Rev.	A

PRODUCT SPECIFICATION

Model No.: FYL-4012UGC1B

Descriptions:
■ Dice material: AlGaInP
■ Emitting Color: Super bright Yellow Green.
■ Device Outline: Φ4mm round type.
■ Lens Type: Water clear.



CUSTOMER APPROVED SIGNATURES	APPROVED BY	CHECKED BY	PREPARED BY

NINGBO FORYARD OPTOELECTRONICS CO.,LTD.

Add: NO.115 Qixin Road Ningbo Zhejiang China

Zip: 315051

Tel: 0086-574-87933652 87927870 87922206

Fax: 0086-574-87927917

E-mail: Sales@foryard.com (General)

Http://www.foryard.com

[Http://www.foryard.com](http://www.foryard.com)

Model. No.	FYL-4012UGC1B
Rev.	A

■ Features

1. Low power consumption.
2. High efficiency.
3. General purpose leads.
4. High intensity.
5. RoHs compliant.

■ Package configuration

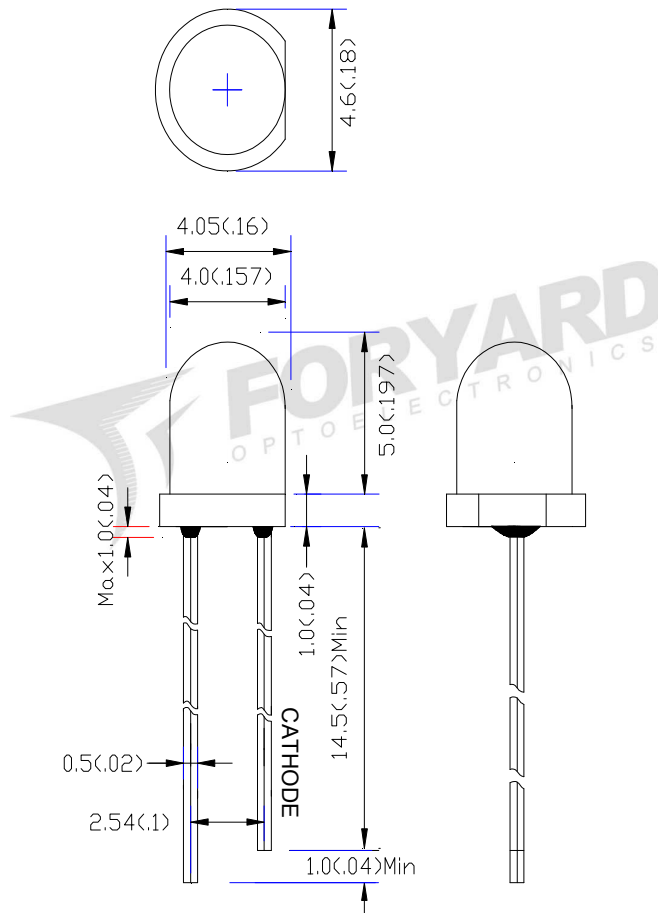

Notes:

1. All dimensions are millimeters (inches)
2. Tolerance is $\pm 0.25\text{mm}$ ($.010''$) unless otherwise noted.
3. The specifications, characteristics and technical data described in the datasheet are subject to change without prior notice.

■ Absolute maximum ratings($T_a=25\text{ }^\circ\text{C}$)

Parameter	MAX.	Unit
Power Dissipation	75	mW
Peak Forward Current (1/10 Duty Cycle, 0.1ms Pulse Width)	100	mA
Continuous Forward Current	30	mA
Derating Linear From 50°C	0.4	mA/°C
Reverse Voltage	5	V
Operating Temperature Range	-40°C to +85°C	
Storage Temperature Range	-40°C to +100°C	
Lead Soldering Temperature[4mm(.157") From Body]	260°C for 5 Seconds	

■ Electrical and optical characteristics($T_a=25\text{ }^\circ\text{C}$)

Parameter	Symbol	Min.	Typ.	Max.	Unit	Test Condition
Luminous Intensity	I_v	-	1000	-	mcd	$I_F=20\text{mA}$
Viewing Angle	$2\theta_{1/2}$	-	30	-	Deg	
Peak Emission Wavelength	λ_p	563	568	573	nm	
Dominant Wavelength	λ_d	565	570	575	nm	
Spectral Line Half-Width	$\Delta\lambda$	-	20	-	nm	
Forward Voltage	V_F	1.8	2.1	2.6	V	
Reverse Current	I_R			10	μA	$V_R=5\text{V}$

■ Typical Electrical Characteristics Curves

(25 °c Ambient Temperature Unless Otherwise Noted)

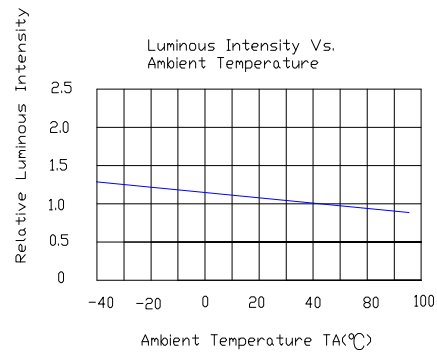
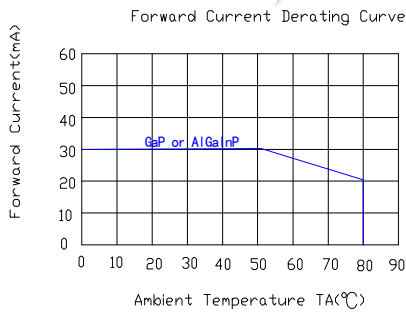
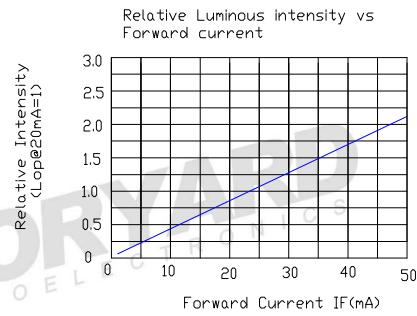
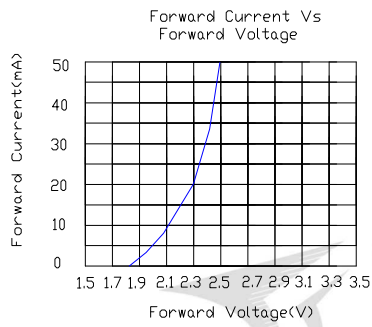
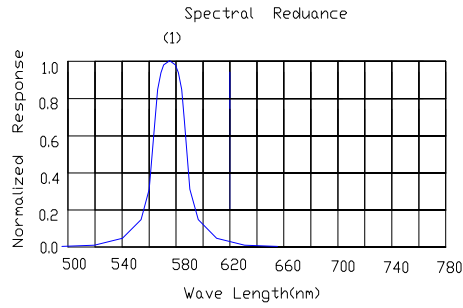

Radiation pattern.

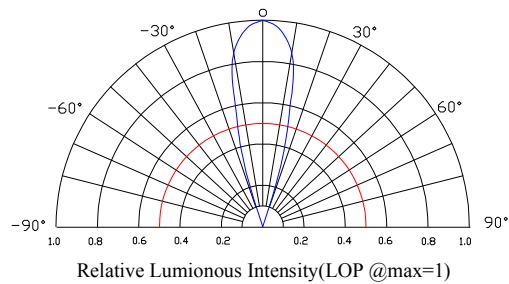

Model. No.	FYL-4012UGC1B
Rev.	A

■ LAMP PACKING

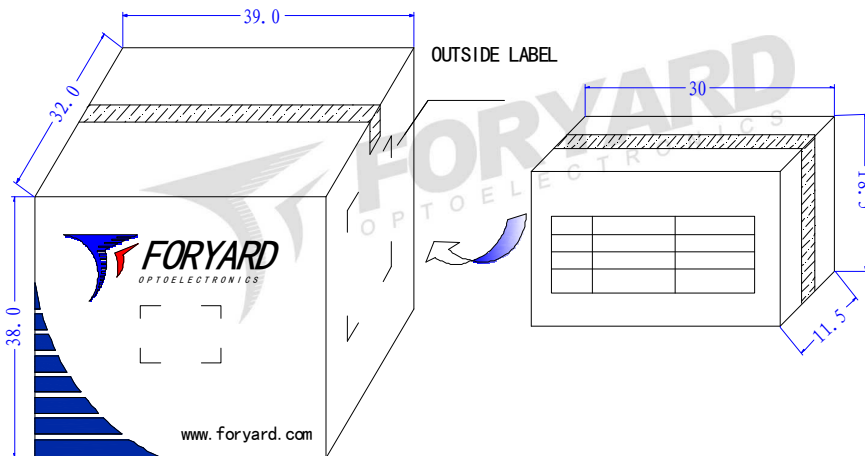
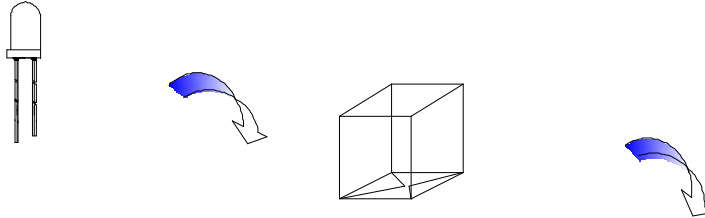

OUTSIDE LABEL