

Model. No.	FYL-3014GD1A
Rev.	A

PRODUCT SPECIFICATION

Model No.: FYL-3014GD1A

Descriptions:
■ Dice material: GaP
■ Emitting Color: Yellow Green
■ Device Outline: Φ3mm round type.
■ Lens Type: Green diffused



CUSTOMER APPROVED SIGNATURES	APPROVED BY	CHECKED BY	PREPARED BY

NINGBO FORYARD OPTOELECTRONICS CO.,LTD.

Add: NO.115 Qixin Road Ningbo Zhejiang China

Zip: 315051

Tel: 0086-574-87933652 87927870 87922206

Fax: 0086-574-87927917

E-mail: Sales@foryard.com (General)

Http://www.foryard.com

■ Absolute maximum ratings($T_a=25\text{ }^\circ\text{C}$)

Parameter	MAX.	Unit
Power Dissipation	75	mW
Peak Forward Current (1/10 Duty Cycle, 0.1ms Pulse Width)	100	mA
Continuous Forward Current	30	mA
Derating Linear From 50°C	0.4	mA/°C
Reverse Voltage	5	V
Operating Temperature Range	-40°C to +85°C	
Storage Temperature Range	-40°C to +100°C	
Lead Soldering Temperature[4mm(.157") From Body]	260°C for 5 Seconds	

■ Electrical and optical characteristics($T_a=25\text{ }^\circ\text{C}$)

Parameter	Symbol	Min.	Typ.	Max.	Unit	Test Condition
Luminous Intensity	I_v	-	40	-	mcd	$I_F=20\text{mA}$
Viewing Angle	$2\theta_{1/2}$	-	40	-	Deg	
Peak Emission Wavelength	λ_p	563	568	573	nm	
Dominant Wavelength	λ_d	565	570	575	nm	
Spectral Line Half-Width	$\Delta\lambda$	-	20	-	nm	
Forward Voltage	V_F	1.8	2.1	2.6	V	
Reverse Current	I_R			10	μA	$V_R=5\text{V}$

■ Typical Electrical Characteristics Curves

(25 °c Ambient Temperature Unless Otherwise Noted)

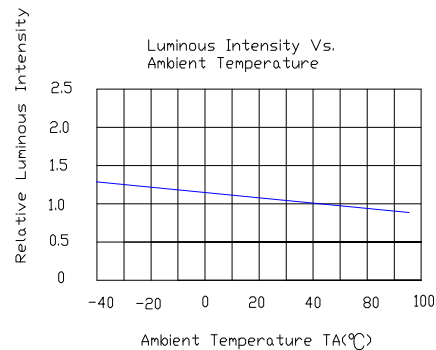
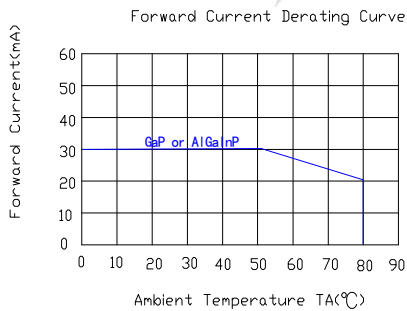
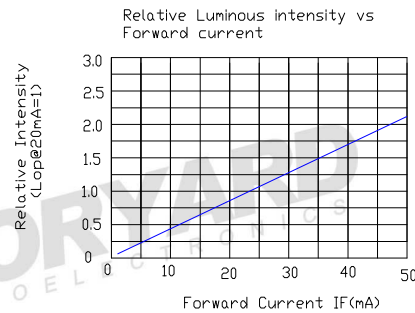
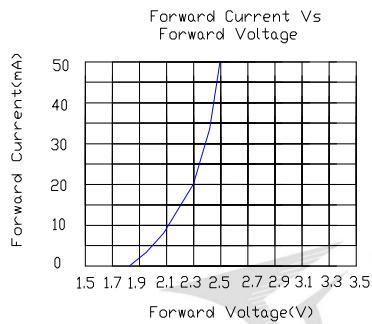
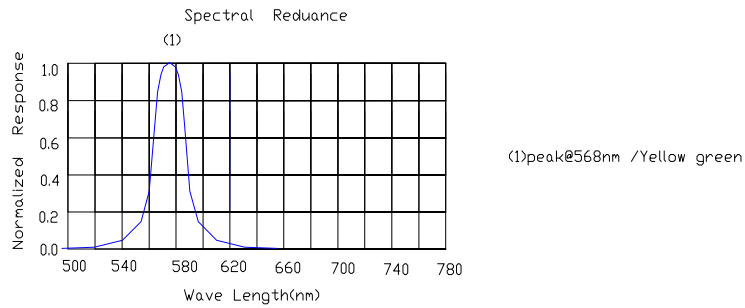

Radiation pattern.

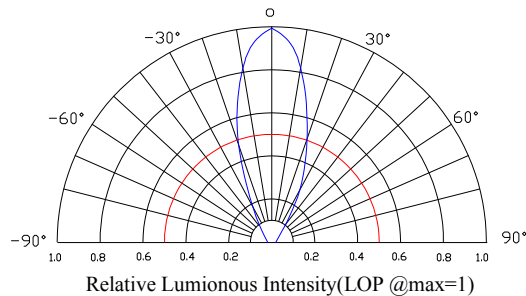

Model. No.	FYL-3014GD1A
Rev.	A

■ LAMP PACKING

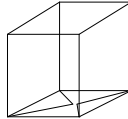

3mm 1000PCS/Polybag

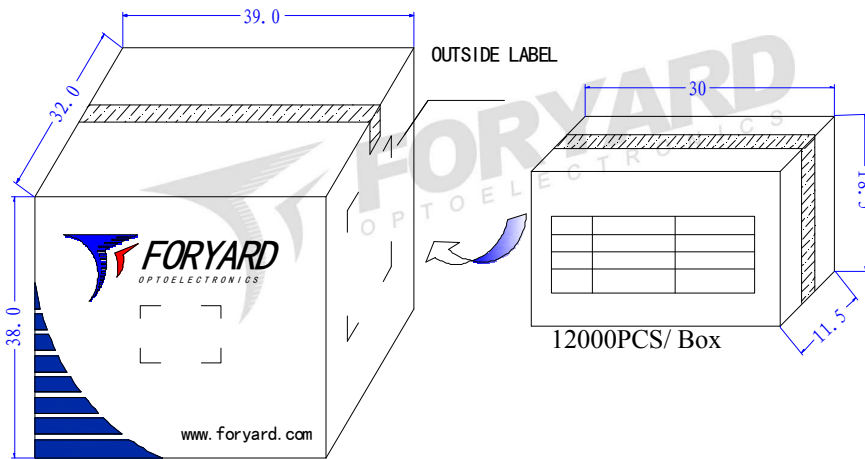

72000PCS/ Carton



OUTSIDE LABEL