

BGS12AL7-6

SPDT RF Switch

Data Sheet

Revision 2.1, 2009-12-09

RF & Protection Devices

Edition 2009-12-09

**Published by
Infineon Technologies AG
81726 Munich, Germany**

**© 2009 Infineon Technologies AG
All Rights Reserved.**

Legal Disclaimer

The information given in this document shall in no event be regarded as a guarantee of conditions or characteristics. With respect to any examples or hints given herein, any typical values stated herein and/or any information regarding the application of the device, Infineon Technologies hereby disclaims any and all warranties and liabilities of any kind, including without limitation, warranties of non-infringement of intellectual property rights of any third party.

Information

For further information on technology, delivery terms and conditions and prices, please contact the nearest Infineon Technologies Office (www.infineon.com).

Warnings

Due to technical requirements, components may contain dangerous substances. For information on the types in question, please contact the nearest Infineon Technologies Office.

Infineon Technologies components may be used in life-support devices or systems only with the express written approval of Infineon Technologies, if a failure of such components can reasonably be expected to cause the failure of that life-support device or system or to affect the safety or effectiveness of that device or system. Life support devices or systems are intended to be implanted in the human body or to support and/or maintain and sustain and/or protect human life. If they fail, it is reasonable to assume that the health of the user or other persons may be endangered.

BGS12AL7-6 SPDT RF Switch
Revision History: 2009-12-09, Revision 2.1
Previous Revision: 2009-11-24, V2.0

Page	Subjects (major changes since last revision)
11	max. Values for Insertion Loss @ $T_A = -30\text{ }^\circ\text{C} \dots +85\text{ }^\circ\text{C}$

Trademarks of Infineon Technologies AG

A-GOLD™, BlueMoon™, COMNEON™, CONVERGATE™, COSIC™, C166™, CROSSAVE™, CanPAK™, CIPOS™, CoolMOS™, CoolSET™, CONVERPATH™, CORECONTROL™, DAVE™, DUALFALC™, DUSLIC™, EasyPIM™, EconoBRIDGE™, EconoDUAL™, EconoPACK™, EconoPIM™, E-GOLD™, EiceDRIVER™, EUPEC™, ELIC™, EPIC™, FALC™, FCOS™, FLEXISLIC™, GEMINAX™, GOLDMOS™, HITFET™, HybridPACK™, INCA™, ISAC™, ISOFACE™, IsoPACK™, IWORX™, M-GOLD™, MIPAQ™, ModSTACK™, MUSLIC™, my-d™, NovalithIC™, OCTALFALC™, OCTAT™, OmniTune™, OmniVia™, OptiMOS™, OPTIVERSE™, ORIGA™, PROFET™, PRO-SIL™, PrimePACK™, QUADFALC™, RASIC™, ReverSave™, SatRIC™, SCEPTRE™, SCOUT™, S-GOLD™, SensoNor™, SEROCCO™, SICOFI™, SIEGET™, SINDRION™, SLIC™, SMARTi™, SmartLEWIS™, SMINT™, SOCRATES™, TEMPFET™, thinQ!™, TrueENTRY™, TriCore™, TRENCHSTOP™, VINAX™, VINETIC™, VIONTIC™, WildPass™, X-GOLD™, XMM™, X-PMU™, XPOSYS™, XWAY™.

Other Trademarks

AMBA™, ARM™, MULTI-ICE™, PRIMECELL™, REALVIEW™, THUMB™ of ARM Limited, UK. AUTOSAR™ is licensed by AUTOSAR development partnership. Bluetooth™ of Bluetooth SIG Inc. CAT-iq™ of DECT Forum. COLOSSUS™, FirstGPS™ of Trimble Navigation Ltd. EMV™ of EMVCo, LLC (Visa Holdings Inc.). EPCOS™ of Epcos AG. FLEXGO™ of Microsoft Corporation. FlexRay™ is licensed by FlexRay Consortium. HYPERTERMINAL™ of Hilgraeve Incorporated. IEC™ of Commission Electrotechnique Internationale. IrDA™ of Infrared Data Association Corporation. ISO™ of INTERNATIONAL ORGANIZATION FOR STANDARDIZATION. MATLAB™ of MathWorks, Inc. MAXIM™ of Maxim Integrated Products, Inc. MICROTEC™, NUCLEUS™ of Mentor Graphics Corporation. Mifare™ of NXP. MIPI™ of MIPI Alliance, Inc. MIPS™ of MIPS Technologies, Inc., USA. muRata™ of MURATA MANUFACTURING CO. OmniVision™ of OmniVision Technologies, Inc. Openwave™ Openwave Systems Inc. RED HAT™ Red Hat, Inc. RFMD™ RF Micro Devices, Inc. SIRIUS™ of Sirius Sattelite Radio Inc. SOLARIS™ of Sun Microsystems, Inc. SPANSION™ of Spansion LLC Ltd. Symbian™ of Symbian Software Limited. TAIYO YUDEN™ of Taiyo Yuden Co. TEAKLITE™ of CEVA, Inc. TEKTRONIX™ of Tektronix Inc. TOKO™ of TOKO KABUSHIKI KAISHA TA. UNIX™ of X/Open Company Limited. VERILOG™, PALLADIUM™ of Cadence Design Systems, Inc. VLYNQ™ of Texas Instruments Incorporated. VXWORKS™, WIND RIVER™ of WIND RIVER SYSTEMS, INC. ZETEX™ of Diodes Zetex Limited.

Last Trademarks Update 2009-10-19

Table of Contents

	Table of Contents	4
	List of Figures	5
	List of Tables	6
1	Features	7
2	Maximum Ratings	9
3	Pin Description	10
4	Electrical Specifications	11
5	Measurement Results	12
6	Package Outlines	14

List of Figures

Figure 1	Functional Diagram	8
Figure 2	Pin Configuration (top view)	10
Figure 3	Measurement Results (@ T = 25°C)	12
Figure 4	Application Board: No External Components Necessary	13
Figure 5	Deembedding Board	13
Figure 6	Package TSLP7-6	14
Figure 7	Marking Info	14
Figure 8	Board pad (SMD) & Apertures	14
Figure 9	Tape and Reel	15

List of Tables

Table 1	Maximum Ratings	9
Table 2	Operation Ranges	9
Table 3	Pin Description	10
Table 4	Truth Table	10
Table 5	Electrical Characteristics	11

1 Features

Main features:

- Low insertion loss
- High port-to-port-isolation
- Low harmonic generation
- On-chip control logic, only one control line required
- High ESD robustness
- No external components required
- General purpose switch for applications up to 3 GHz
- Small leadless package TSLP-7-6
- Lead and halogen free package (RoHS and WEEE compliant)

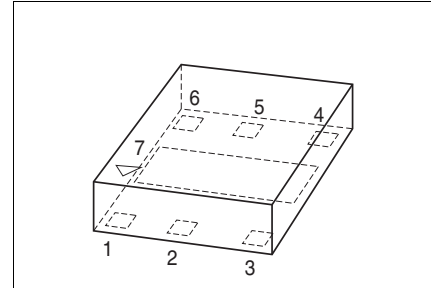

Description

The BGS12AL7-6 General Purpose RF MOS switch is designed to cover a broad range of applications from 30 MHz to 3 GHz. The symmetric design of its single pole double throw configuration, as shown in **Figure 1** offers high design flexibility. This single supply chip integrates on-chip CMOS logic driven by a simple, single-pin CMOS or TTL compatible control input signal. The 0.1 dB compression point exceeds the switch's maximum input power level of 21 dBm, resulting in linear performance at all signal levels. The RF switch has a very low insertion loss of 0.4 dB in the 1 GHz and 0.5 dB in the 2 GHz range.

Unlike GaAs technology, external DC blocking capacitors at the RF ports are only required if DC voltage is applied externally.

Product Name	Package	Chip	Marking
BGS12AL7-6	TSLP7-6	M4781	12

The BGS12AL7-6 RF switch is manufactured in Infineon's patented MOS technology, offering the performance of GaAs with the economy and integration of conventional CMOS including the inherent higher ESD robustness.

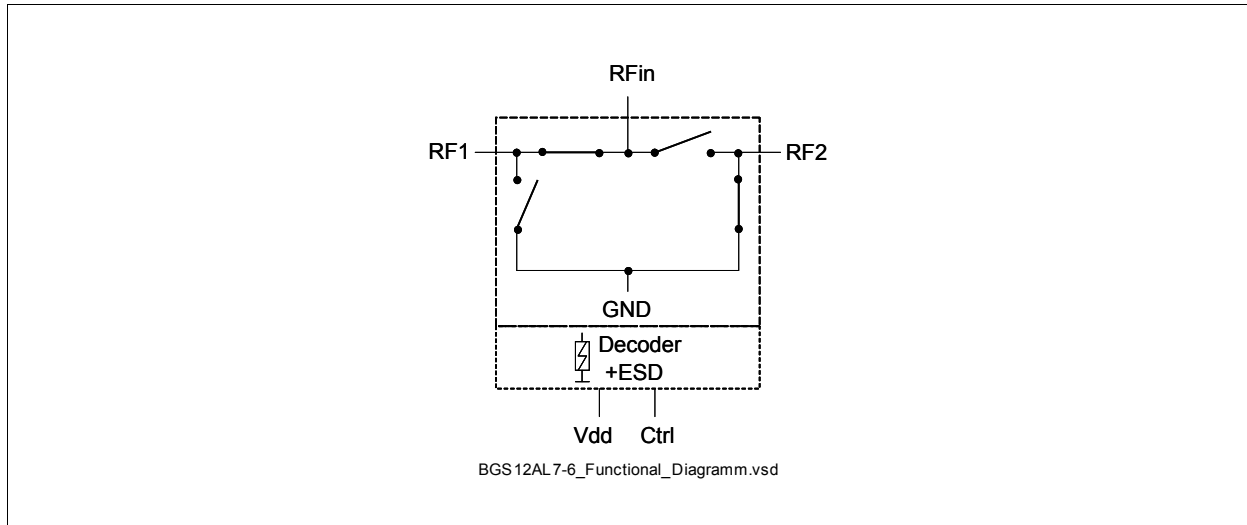

Figure 1 Functional Diagram

2 Maximum Ratings

Table 1 Maximum Ratings

Parameter	Symbol	Values			Unit	Note / Test Condition
		Min.	Typ.	Max.		
Storage temperature range	T_{stg}	-65	–	150	°C	–
DC Voltage at all pins to GND	V_{DC}	–	–	5	V	–
RF power max. at all RF ports	P_{IN}	–	–	24	dBm	–

ESD Capability

Human Body Model IEC61340-3-1	V_{ESD}	–	–	1000	V	–
Machine Model IEC61340-3-2		–	–	100		–
Charge Device Model JEDEC JESD22-C101D		–	–	1500		–

Table 2 Operation Ranges

Parameter	Symbol	Values			Unit	Note / Test Condition
		Min.	Typ.	Max.		
Ambient temperature	T_A	-30	–	85	°C	–
RF Frequency	f	0.03	–	3	GHz	–
Control voltage low	V_{Ctrl}	-0.3	–	0.3	V	–
Control voltage high	V_{CtrlH}	1.4	–	V _{dd}	V	–
Supply voltage ¹⁾	V_{dd}	2.4	–	3.6	V	–
Current consumption V _{dd} Pin (over temperature)	I_{Vdd}	80	–	350	μA	–
Current Consumption V _{ctrl} Pin	I_{Ctrl}	–	–	30	μA	–
Power Range	P_{in}	–	–	–	dBm	–
(VSWR ∞: 1)		–	–	15		–
(VSWR 3: 1)		–	–	18		–
(VSWR 1: 1)		–	–	21		–

1) Supply voltage must be connected before Control Voltage

Attention: Stresses above the max. values listed here may cause permanent damage to the device. Exposure to absolute maximum rating conditions for extended periods may affect device reliability. Maximum ratings are absolute ratings; exceeding only one of these values may cause irreversible damage to the integrated circuit.

3 Pin Description

Table 3 Pin Description

Pin No.	Name	Pin Type	Buffer Type	Function
1	RF2	I/O		RF Port 2 Out
2	GND	GND		Ground
3	RF1	I/O		RF Port 1 Out
4	Vdd	PWR		Supply Voltage
5	RFIN	I/O		RF Port In
6	CTRL	I		Control Pin
7	NC	NC		It is recommended to connect Pin 7 to Ground

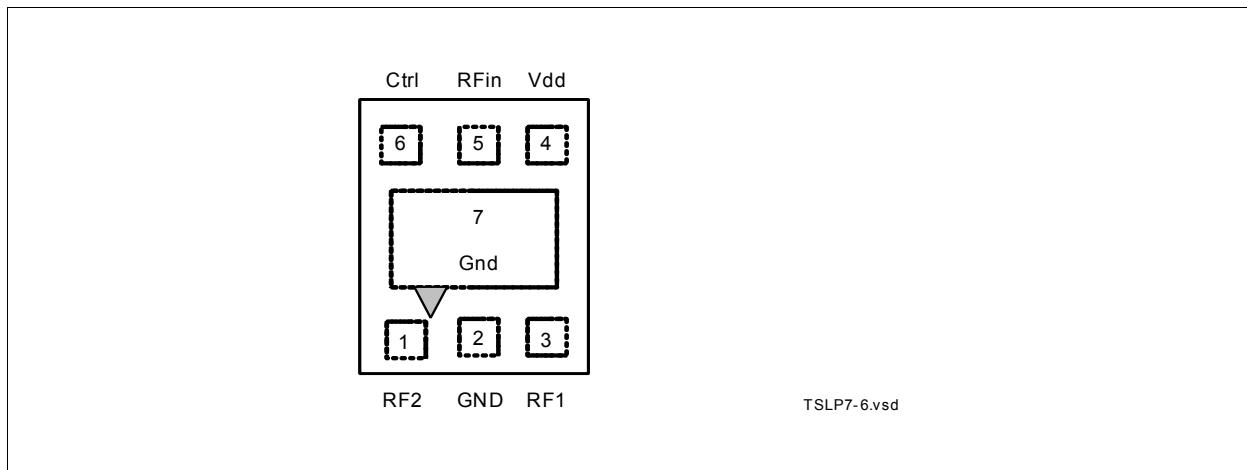

Figure 2 Pin Configuration (top view)

Table 4 Truth Table

Ctrl 1	RF 1	RF 2
0	1	0
1	0	1

4 Electrical Specifications

Test Conditions:

- Termination port impedance: $Z_0 = 50 \Omega$
- Temperature range: $T_A = -30 \text{ °C} \dots +85 \text{ °C}$
- Supply Voltage: $V_{dd} = 2.8 \text{ V}$
- $P_{in} = 15 \text{ dBm}$
- Across operating range of control voltages: $V_{Ctrl} = 1.4 \dots 2.8 \text{ V}$

Table 5 Electrical Characteristics

Parameter	Symbol	Values			Unit	Note / Test Condition
		Min.	Typ.	Max.		
Insertion Loss	IL	–	0.3 ¹⁾	0.5 ¹⁾	dB	$f = 0.1 \text{ GHz}, T_A = 25 \text{ °C}$
		–	0.35	0.6	dB	$f = 1 \text{ GHz}, T_A = 25 \text{ °C}$
		–	0.5	0.7	dB	$f = 2 \text{ GHz}, T_A = 25 \text{ °C}$
		–	–	0.6 ¹⁾	dB	$f = 0.1 \text{ GHz}$
		–	–	0.7 ¹⁾	dB	$f = 1 \text{ GHz}$
		–	–	0.8 ¹⁾	dB	$f = 2 \text{ GHz}$
Return Loss	RL	–	30 ¹⁾	–	dB	$f = 0.1 \text{ GHz}$
		15	20	–	dB	$f = 1 \text{ GHz}$
		12	15	–	dB	$f = 2 \text{ GHz}$
Isolation RFin - RF1	$ISO_{RFin-RF1}$	–	50 ¹⁾	–	dB	$f = 0.1 \text{ GHz}$
		20	32	–	dB	$f = 1 \text{ GHz}$
		15	25	–	dB	$f = 2 \text{ GHz}$
Isolation RFin - RF2	$ISO_{RFin-RF2}$	–	50 ¹⁾	–	dB	$f = 0.1 \text{ GHz}$
		20	32	–	dB	$f = 1 \text{ GHz}$
		15	25	–	dB	$f = 2 \text{ GHz}$
Isolation RF1 - RF2	$ISO_{RF1-RF2}$	–	50 ¹⁾	–	dB	$f = 0.1 \text{ GHz}$
		24	32	–	dB	$f = 1 \text{ GHz}$
		15	25	–	dB	$f = 2 \text{ GHz}$
Isolation RF ports - Vdd, Vctrl	ISO_{RF-DC}	25	30 ¹⁾	–	dB	$f = 1 \text{ GHz}$
		15	20 ¹⁾	–	dB	$f = 2 \text{ GHz}$
Harmonic Generation up to 12.75 GHz	P_{Harm}	–	-75 ¹⁾	-50	dBm	$f = 1 \text{ GHz}$
		–	-80 ¹⁾	-50	dBm	$f = 2 \text{ GHz}$
On Switching Time (10-90%) RF	t_{on}	–	3 ¹⁾	5	μs	$f = 1 \text{ GHz}$
Off Switching Time (10-90%) RF	t_{off}	–	0.5 ¹⁾	5	μs	$f = 1 \text{ GHz}$
Current Consumption at Vdd Pin	I_{dd}	–	140	–	μA	–
Input 0.1 dB compression	$P_{0.1dB}$	21 ¹⁾	–	–	dBm	$f = 1 \text{ GHz}$

1) Not measured in production, verified by design

5 Measurement Results

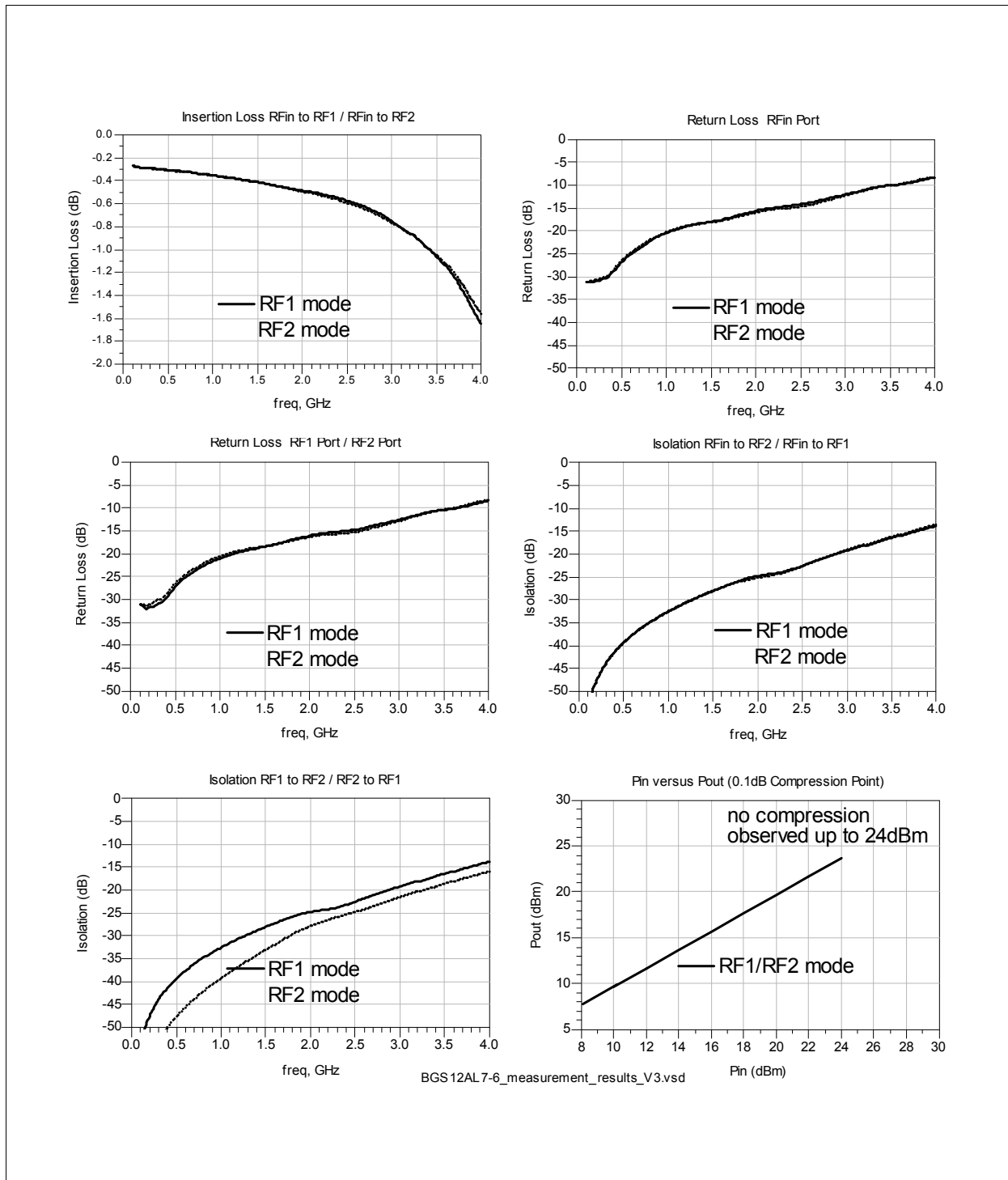

Figure 3 Measurement Results (@ T = 25°C)

Application Board

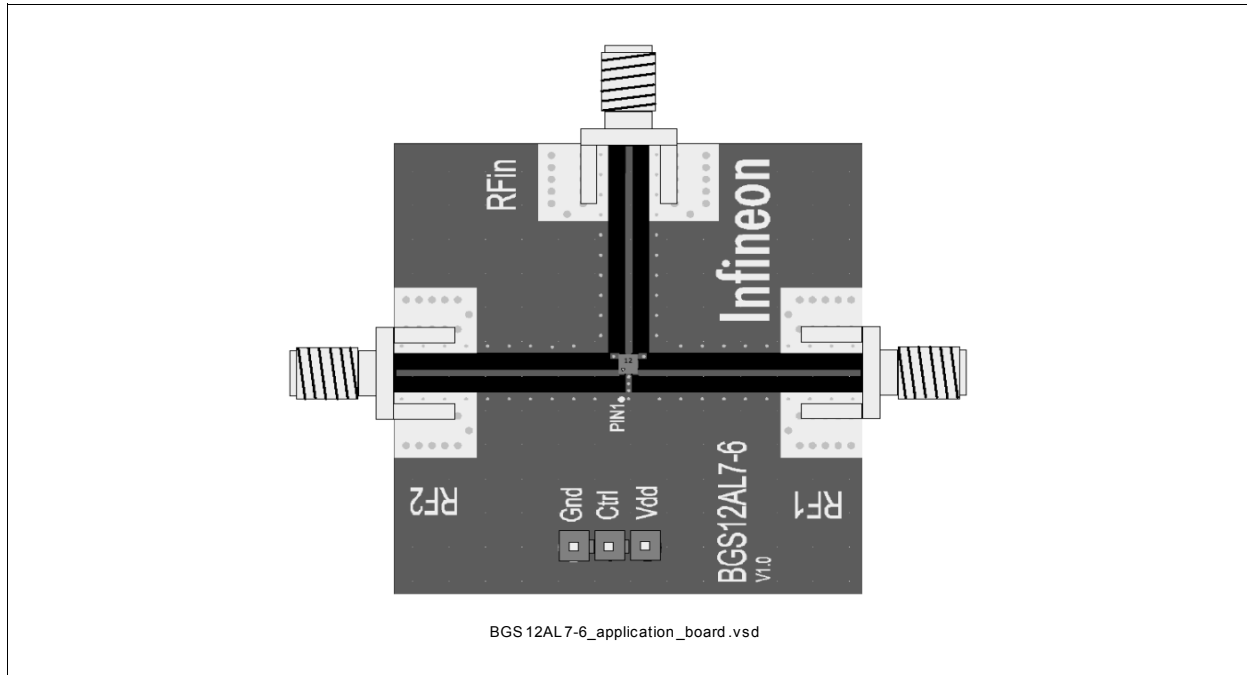

Figure 4 Application Board: No External Components Necessary

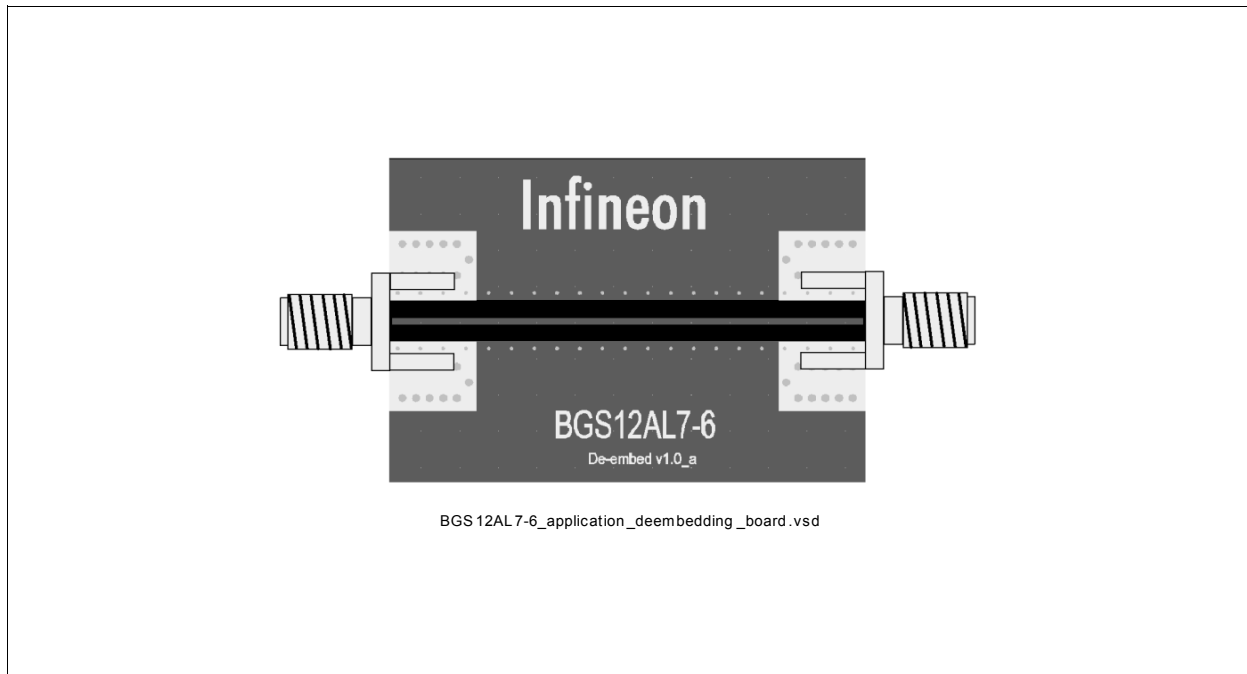

Figure 5 Deembedding Board

6 Package Outlines

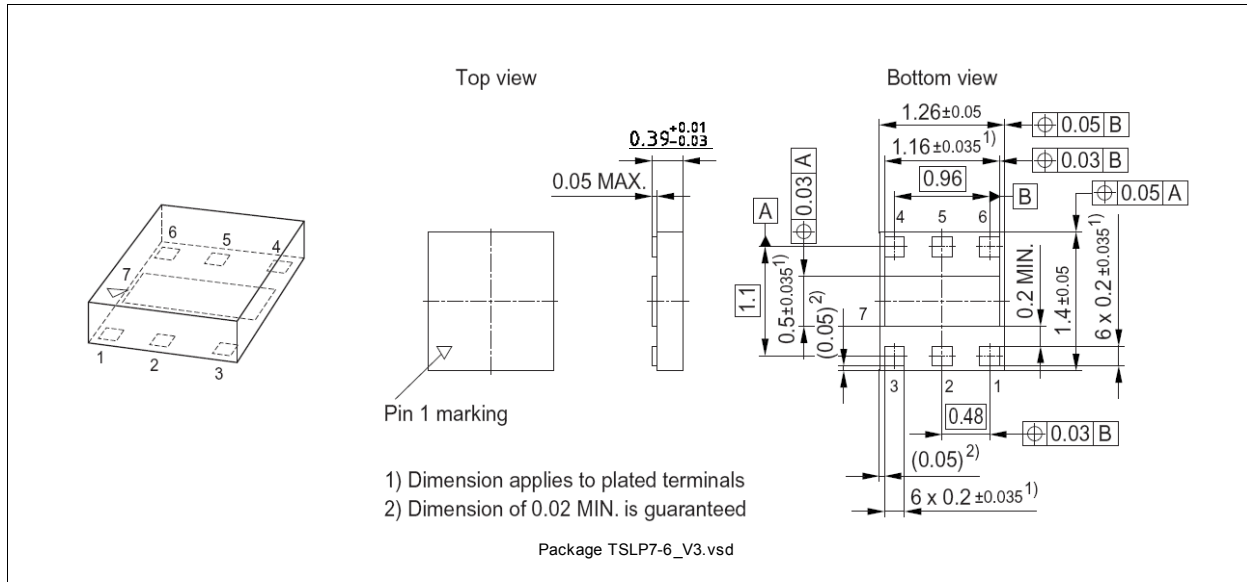

Figure 6 Package TSLP7-6

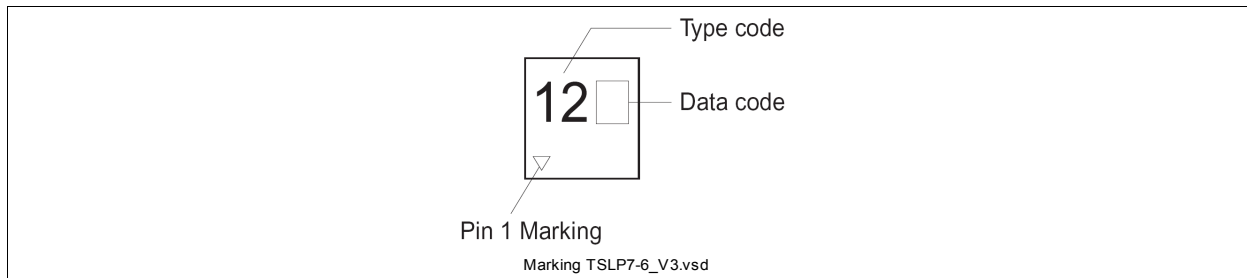

Figure 7 Marking Info

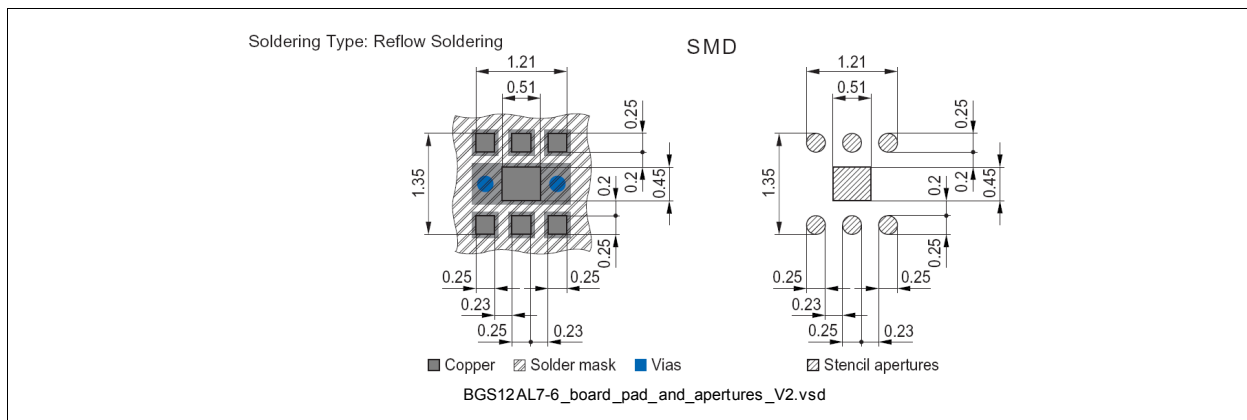

Figure 8 Board pad (SMD) & Apertures

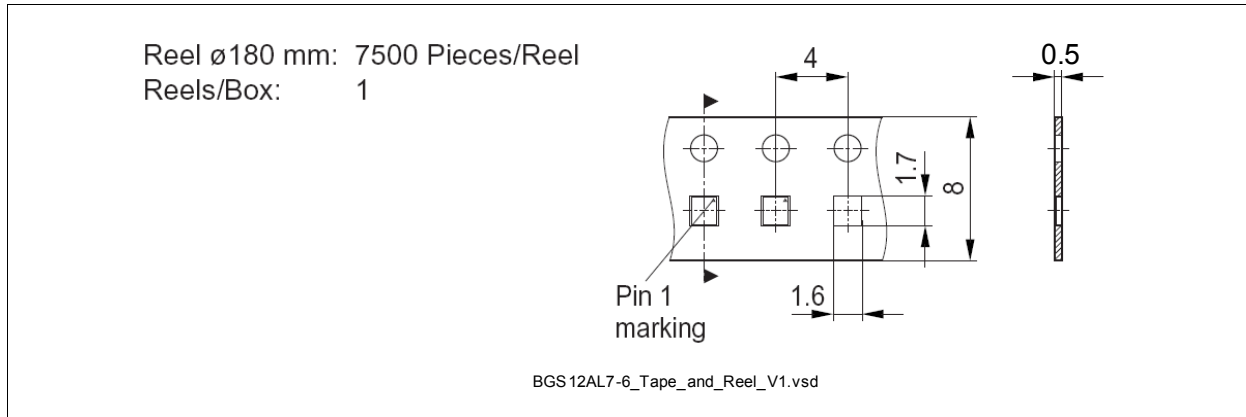

Figure 9 Tape and Reel

Dimensions in mm

You can find all of our packages, sorts of packing and others in our Infineon Internet Page "Products":
<http://www.infineon.com/products>.

www.infineon.com

Published by Infineon Technologies AG