

Silicon Tuning Diodes

- Excellent linearity
- High Q hyperabrupt tuning diode
- Low series resistance
- Designed for low tuning voltage operation for VCO's in mobile communications equipment
- For low frequency control elements such as TCXOs and VCXOs
- Very low capacitance spread
- Pb-free (RoHS compliant) package¹⁾
- Qualified according AEC Q101

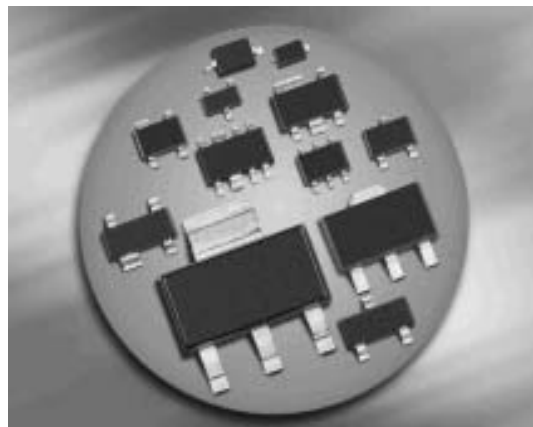

BBY58-02L/V
BBY58-02W
BBY58-03W

BBY58-05W

BBY58-06W

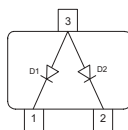
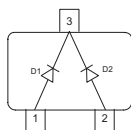
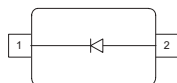

| Type | Package | Configuration | L_S (nH) | Marking |
|-----------|----------|------------------|------------|---------|
| BBY58-02L | TSLP-2-1 | single, leadless | 0.4 | 88 |
| BBY58-02V | SC79 | single | 0.6 | 8 |
| BBY58-02W | SCD80 | single | 0.6 | 88 |
| BBY58-03W | SOD323 | single | 0.6 | 8 yel. |
| BBY58-05W | SOT323 | common cathode | 1.4 | B5s |
| BBY58-06W | SOT323 | common anode | 1.4 | B6s |

Maximum Ratings at $T_A = 25^\circ\text{C}$, unless otherwise specified

| Parameter | Symbol | Value | Unit |
|-----------------------------|-----------|-------------|------|
| Diode reverse voltage | V_R | 10 | V |
| Forward current | I_F | 20 | mA |
| Operating temperature range | T_{op} | -55 ... 150 | °C |
| Storage temperature | T_{stg} | -55 ... 150 | |

¹Pb-containing package may be available upon special request

Electrical Characteristics at $T_A = 25^\circ\text{C}$, unless otherwise specified

| Parameter | Symbol | Values | | | Unit |
|------------------------------------------------------------------------|-----------------|--------|-------|------|----------|
| | | min. | typ. | max. | |
| DC Characteristics | | | | | |
| Reverse current | I_R | | | | nA |
| $V_R = 8\text{ V}$ | | - | - | 10 | |
| $V_R = 8\text{ V}, T_A = 85^\circ\text{C}$ | | - | - | 100 | |
| AC Characteristics | | | | | |
| Diode capacitance | C_T | | | | pF |
| $V_R = 1\text{ V}, f = 1\text{ MHz}$ | | 17.5 | 18.3 | 19.3 | |
| $V_R = 2\text{ V}, f = 1\text{ MHz}$ | | 11.4 | 12.35 | 13.3 | |
| $V_R = 3\text{ V}, f = 1\text{ MHz}$ | | 7.8 | 8.6 | 9.3 | |
| $V_R = 4\text{ V}, f = 1\text{ MHz}$ | | 5.5 | 6 | 6.6 | |
| $V_R = 6\text{ V}, f = 1\text{ MHz}$ | | 3.8 | 4.7 | 5.5 | |
| Capacitance ratio | C_{T1}/C_{T3} | 1.9 | 2.15 | 2.4 | - |
| $V_R = 1\text{ V}, V_R = 3\text{ V}, f = 1\text{ MHz}$ | | | | | |
| Capacitance ratio | C_{T1}/C_{T4} | 2.7 | 3.05 | 3.5 | |
| $V_R = 1\text{ V}, V_R = 4\text{ V}, f = 1\text{ MHz}$ | | | | | |
| Capacitance ratio | C_{T4}/C_{T6} | 1.15 | 1.3 | 1.45 | |
| $V_R = 4\text{ V}, V_R = 6\text{ V}, f = 1\text{ MHz}$ | | | | | |
| Series resistance | r_S | | | | Ω |
| $V_R = 1\text{ V}, f = 470\text{ MHz}, \text{BBY58-02L}, -07\text{L4}$ | | - | 0.3 | - | |
| $V_R = 1\text{ V}, f = 470\text{ MHz}, \text{all other}$ | | - | 0.25 | - | |

Diode capacitance $C_T = f(V_R)$

$f = 1\text{MHz}$

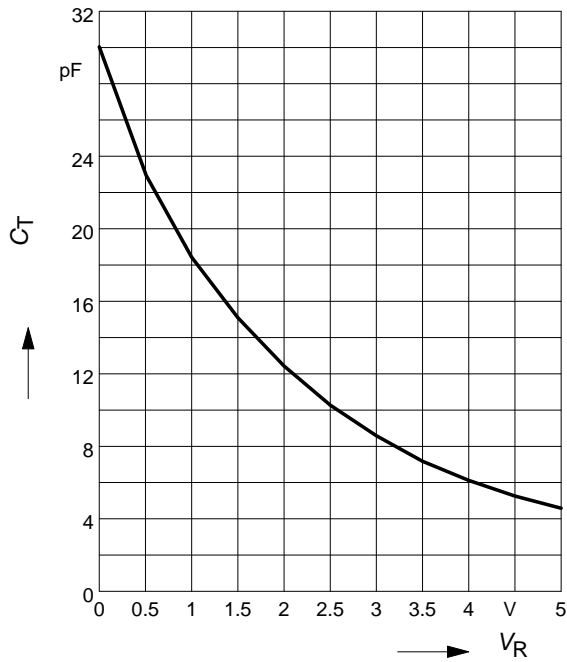

Normalized diode capacitance

$C_{(T_A)}/C_{(25^\circ\text{C})} = f(T_A)$

$f = 1\text{MHz}, V_R = \text{Parameter}$

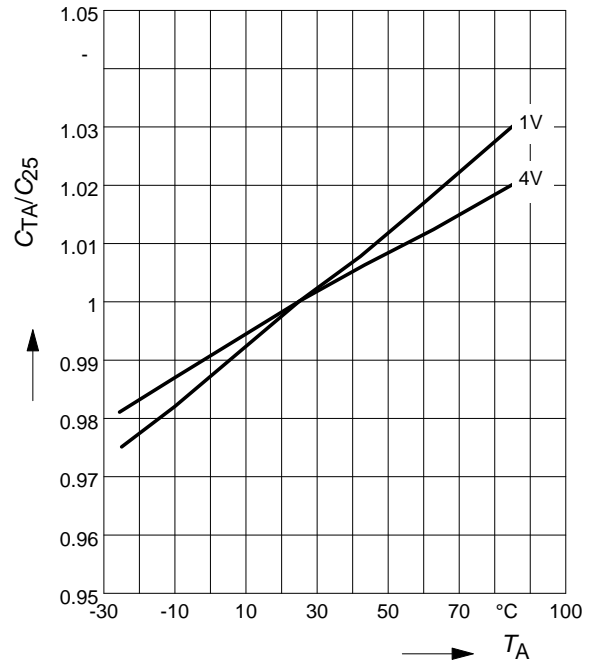

Temperature coefficient of the diode capacitance $T_{CC} = f(V_R)$

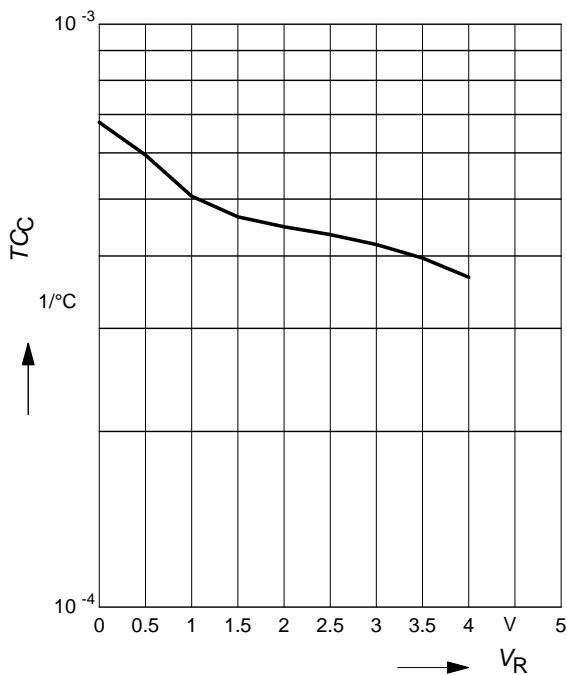

Package Outline

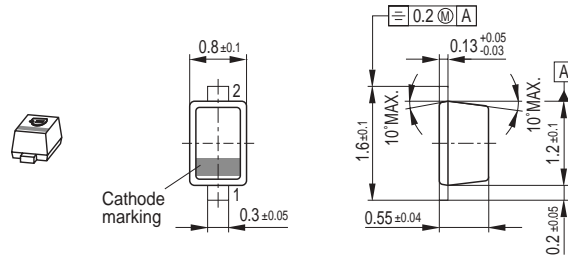

Foot Print

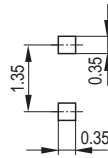

Marking Layout (Example)

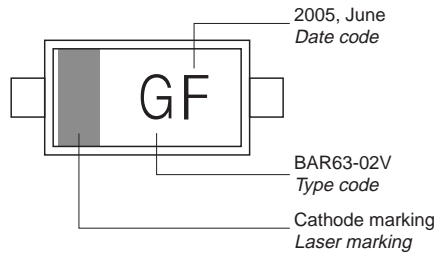

Standard Packing

Reel \varnothing 180 mm = 3.000 Pieces/Reel
 Reel \varnothing 180 mm = 8.000 Pieces/Reel (2 mm Pitch)
 Reel \varnothing 330 mm = 10.000 Pieces/Reel

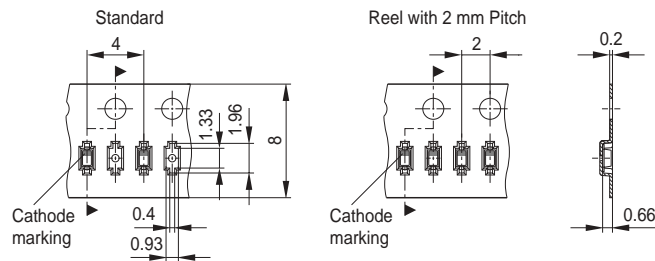

Package Outline

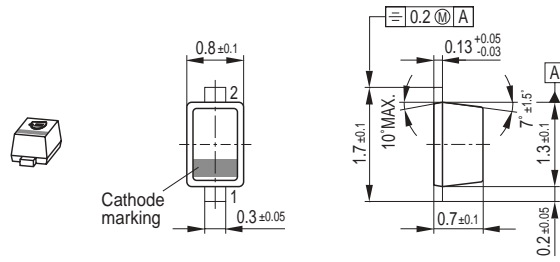

Foot Print

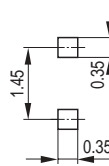

Marking Layout (Example)

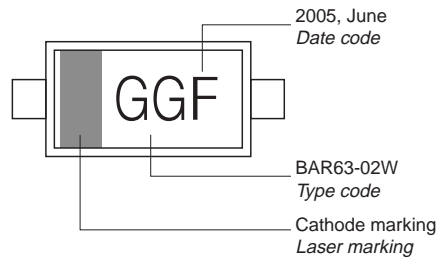

Standard Packing

Reel \varnothing 180 mm = 3.000 Pieces/Reel
 Reel \varnothing 180 mm = 8.000 Pieces/Reel (2 mm Pitch)
 Reel \varnothing 330 mm = 10.000 Pieces/Reel

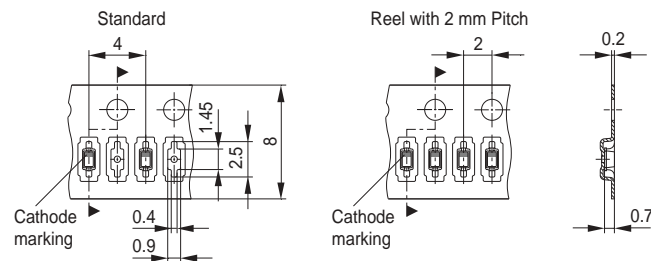

Date Code marking for discrete packages with
one digit (SCD80, SC79, SC75¹⁾) CES-Code

| Month | 2003 | 2004 | 2005 | 2006 | 2007 | 2008 | 2009 | 2010 | 2011 | 2012 | 2013 | 2014 |
|-------|------|------|------|------|------|------|------|------|------|------|------|------|
| 01 | a | p | A | P | a | p | A | P | a | p | A | P |
| 02 | b | q | B | Q | b | q | B | Q | b | q | B | Q |
| 03 | c | r | C | R | c | r | C | R | c | r | C | R |
| 04 | d | s | D | S | d | s | D | S | d | s | D | S |
| 05 | e | t | E | T | e | t | E | T | e | t | E | T |
| 06 | f | u | F | U | f | u | F | U | f | u | F | U |
| 07 | g | v | G | V | g | v | G | V | g | v | G | V |
| 08 | h | x | H | X | h | x | H | X | h | x | H | X |
| 09 | j | y | J | Y | j | y | J | Y | j | y | J | Y |
| 10 | k | z | K | Z | k | z | K | Z | k | z | K | Z |
| 11 | l | 2 | L | 4 | l | 2 | L | 4 | l | 2 | L | 4 |
| 12 | n | 3 | N | 5 | n | 3 | N | 5 | n | 3 | N | 5 |

1) New Marking Layout for SC75, implemented at October 2005.

Package Outline

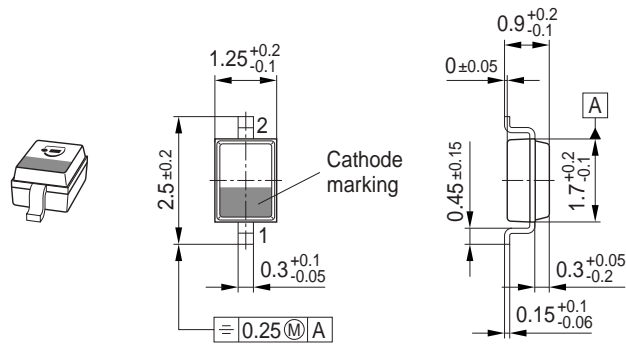

Foot Print

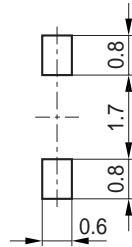

Marking Layout (Example)

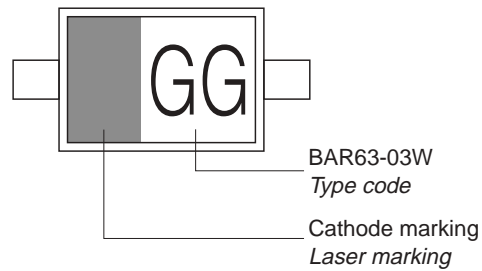

Standard Packing

Reel \varnothing 180 mm = 3.000 Pieces/Reel
 Reel \varnothing 330 mm = 10.000 Pieces/Reel

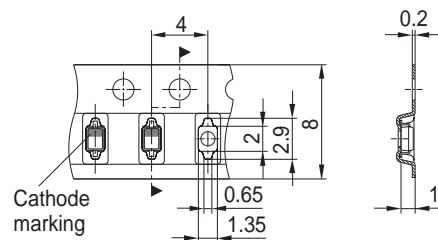

Package Outline

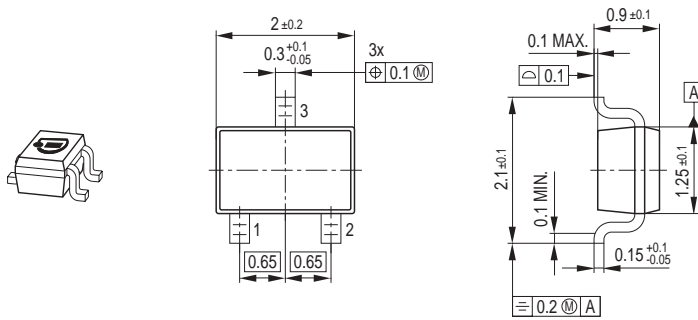

Foot Print

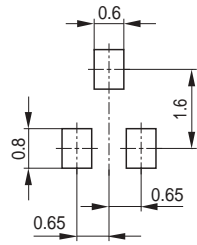

Marking Layout (Example)

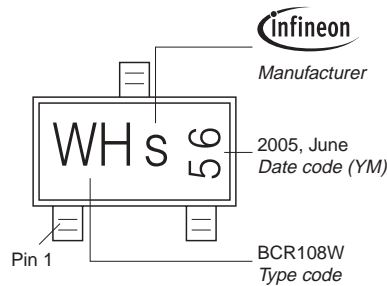

Standard Packing

Reel \varnothing 180 mm = 3.000 Pieces/Reel
 Reel \varnothing 330 mm = 10.000 Pieces/Reel

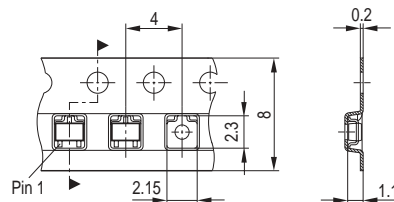

Package Outline

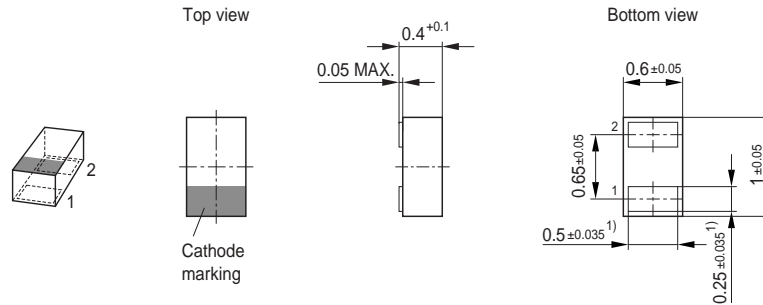

Foot Print

For board assembly information please refer to Infineon website "Packages"

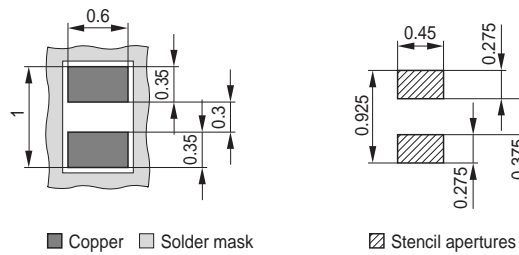

Marking Layout (Example)

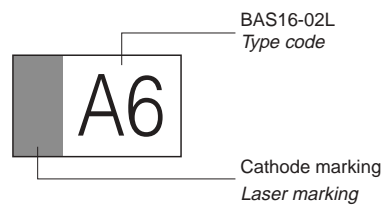

Standard Packing

Reel ø180 mm = 15.000 Pieces/Reel
Reel ø330 mm = 50.000 Pieces/Reel (optional)

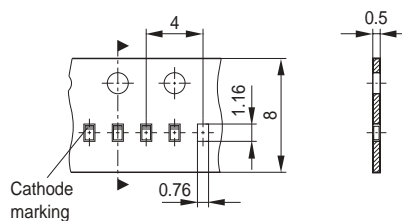

Edition 2006-02-01

Published by

Infineon Technologies AG

81726 München, Germany

© Infineon Technologies AG 2007.

All Rights Reserved.

Attention please!

The information given in this dokument shall in no event be regarded as a guarantee of conditions or characteristics ("Beschaffheitsgarantie"). With respect to any examples or hints given herein, any typical values stated herein and/or any information regarding the application of the device, Infineon Technologies hereby disclaims any and all warranties and liabilities of any kind, including without limitation warranties of non-infringement of intellectual property rights of any third party.

Information

For further information on technology, delivery terms and conditions and prices please contact your nearest Infineon Technologies Office (www.infineon.com).

Warnings

Due to technical requirements components may contain dangerous substances. For information on the types in question please contact your nearest Infineon Technologies Office.

Infineon Technologies Components may only be used in life-support devices or systems with the express written approval of Infineon Technologies, if a failure of such components can reasonably be expected to cause the failure of that life-support device or system, or to affect the safety or effectiveness of that device or system.

Life support devices or systems are intended to be implanted in the human body, or to support and/or maintain and sustain and/or protect human life. If they fail, it is reasonable to assume that the health of the user or other persons may be endangered.