

LED Drivers for High Power LEDs

ILD2035

350 mA Step Down LED Driver

Data Sheet

Revision 1.0, 2011-08-17

Industrial and Multimarket

Edition 2011-08-17

**Published by
Infineon Technologies AG
81726 Munich, Germany**

**© 2011 Infineon Technologies AG
All Rights Reserved.**

Legal Disclaimer

The information given in this document shall in no event be regarded as a guarantee of conditions or characteristics. With respect to any examples or hints given herein, any typical values stated herein and/or any information regarding the application of the device, Infineon Technologies hereby disclaims any and all warranties and liabilities of any kind, including without limitation, warranties of non-infringement of intellectual property rights of any third party.

Information

For further information on technology, delivery terms and conditions and prices, please contact the nearest Infineon Technologies Office (www.infineon.com).

Warnings

Due to technical requirements, components may contain dangerous substances. For information on the types in question, please contact the nearest Infineon Technologies Office.

Infineon Technologies components may be used in life-support devices or systems only with the express written approval of Infineon Technologies, if a failure of such components can reasonably be expected to cause the failure of that life-support device or system or to affect the safety or effectiveness of that device or system. Life support devices or systems are intended to be implanted in the human body or to support and/or maintain and sustain and/or protect human life. If they fail, it is reasonable to assume that the health of the user or other persons may be endangered.

Revision History

Page or Item	Subjects (major changes since previous revision)
Revision 1.0, 2011-08-17	
All	Initial release of data sheet

Trademarks of Infineon Technologies AG

AURIX™, BlueMoon™, C166™, CanPAK™, CIPOS™, CIPURSE™, COMNEON™, EconoPACK™, CoolMOS™, CoolSET™, CORECONTROL™, CROSSAVE™, DAVE™, EasyPIM™, EconoBRIDGE™, EconoDUAL™, EconoPIM™, EiceDRIVER™, eupec™, FCOS™, HITFET™, HybridPACK™, I²RF™, ISOFACE™, IsoPACK™, MIPAQ™, ModSTACK™, my-d™, NovalithIC™, OmniTune™, OptiMOS™, ORIGA™, PRIMARION™, PrimePACK™, PrimeSTACK™, PRO-SIL™, PROFET™, RASIC™, ReverSave™, SatRIC™, SIEGET™, SINDRION™, SIPMOS™, SMARTi™, SmartLEWIS™, SOLID FLASH™, TEMPFET™, thinQ!™, TRENCHSTOP™, TriCore™, X-GOLD™, X-PMU™, XMM™, XPOSYS™.

Other Trademarks

Advance Design System™ (ADS) of Agilent Technologies, AMBA™, ARM™, MULTI-ICE™, KEIL™, PRIMECELL™, REALVIEW™, THUMB™, μVision™ of ARM Limited, UK. AUTOSAR™ is licensed by AUTOSAR development partnership. Bluetooth™ of Bluetooth SIG Inc. CAT-iq™ of DECT Forum. COLOSSUS™, FirstGPS™ of Trimble Navigation Ltd. EMV™ of EMVCo, LLC (Visa Holdings Inc.). EPCOS™ of Epcos AG. FLEXGO™ of Microsoft Corporation. FlexRay™ is licensed by FlexRay Consortium. HYPERTERMINAL™ of Hilgraeve Incorporated. IEC™ of Commission Electrotechnique Internationale. IrDA™ of Infrared Data Association Corporation. ISO™ of INTERNATIONAL ORGANIZATION FOR STANDARDIZATION. MATLAB™ of MathWorks, Inc. MAXIM™ of Maxim Integrated Products, Inc. MICROTEC™, NUCLEUS™ of Mentor Graphics Corporation. Mifare™ of NXP. MIPI™ of MIPI Alliance, Inc. MIPS™ of MIPS Technologies, Inc., USA. muRata™ of MURATA MANUFACTURING CO., MICROWAVE OFFICE™ (MWO) of Applied Wave Research Inc., OmniVision™ of OmniVision Technologies, Inc. Openwave™ Openwave Systems Inc. RED HAT™ Red Hat, Inc. RFMD™ RF Micro Devices, Inc. SIRIUS™ of Sirius Satellite Radio Inc. SOLARIS™ of Sun Microsystems, Inc. SPANSION™ of Spansion LLC Ltd. Symbian™ of Symbian Software Limited. TAIYO YUDEN™ of Taiyo Yuden Co. TEAKLITE™ of CEVA, Inc. TEKTRONIX™ of Tektronix Inc. TOKO™ of TOKO KABUSHIKI KAISHA TA. UNIX™ of X/Open Company Limited. VERILOG™, PALLADIUM™ of Cadence Design Systems, Inc. VLYNQ™ of Texas Instruments Incorporated. VXWORKS™, WIND RIVER™ of WIND RIVER SYSTEMS, INC. ZETEX™ of Diodes Zetex Limited.

Last Trademarks Update 2010-10-26

Table of Contents

	Table of Contents	4
	List of Figures	5
	List of Tables	6
1	Features	8
2	Product Brief	9
3	Maximum Ratings	11
4	Thermal Characteristics	12
5	Electrical Characteristics	14
5.1	DC Characteristics	14
5.2	Switching Characteristics	15
5.3	Digital Signals	15
6	Basic Application Information	16
6.1	Setting the average LED current	16
6.1.1	Temperature Protection Circuit	17
6.2	Switching Parameters	17
7	Application Circuit	24
7.1	Evaluation Board	24
8	Package Information	25

List of Figures

Figure 1	Block Diagram	9
Figure 2	Total Power Dissipation	12
Figure 3	Safe Operating Area	13
Figure 4	Application Circuit	24
Figure 5	ILD2035 on Evaluation Board	24
Figure 6	Package Outline SC74	25
Figure 7	Recommended PCB Footprint for Reflow Soldering	25
Figure 8	Tape Loading	25

List of Tables

Table 1	Pin Definition and Function	10
Table 2	Maximum Ratings	11
Table 3	Maximum Thermal Resistance	12
Table 4	DC Characteristics	14
Table 5	Switching Characteristics	15
Table 6	Digital Control Parameter at Pin EN	15



350 mA Step Down LED Driver with Internal Switch ILD2035

1 Features

- Input voltage range 8 V to 22 V
- Internal switch for up to 400 mA average LED current
- Up to 92 % efficiency
- Over current protection
- Temperature protection mechanism
- Inherent open-circuit LED protection
- Soft-start capability
- Low shut down current
- Typical 3 % output current accuracy
- Minimum external components required
- Small package: SC74



Applications

- LED replacement lamps, e.g. MR16 halogen replacement
- Downlights
- Architectural lighting

Product Name	Package	Pin Configuration						Marking
ILD2035	SC74-6-4	1 = V_S	2 = GND	3 = EN	4 = V_{switch}	5 = GND	6 = V_{sense}	25

2 Product Brief

The ILD2035 is a hysteretic step down LED driver IC for general lighting applications, which is capable to drive high power LEDs with average currents up to 400 mA.

The IC incorporates an input voltage range from 8 to 22 V and an internal power switch. The output current level can be adjusted with an external sense resistor.

Depending on the value of the switching inductor the switching frequency and the voltage ripple can be set.

The precise internal bandgap stabilizes the circuit and provides stable current conditions over temperature range.

To ensure a long lifetime of the LED system, the ILD2035 incorporates an overcurrent protection.

In addition, the integrated thermal protection will actively control the output current to protect the LEDs and the IC against thermal stress and hence ensure longer LED lifetimes.

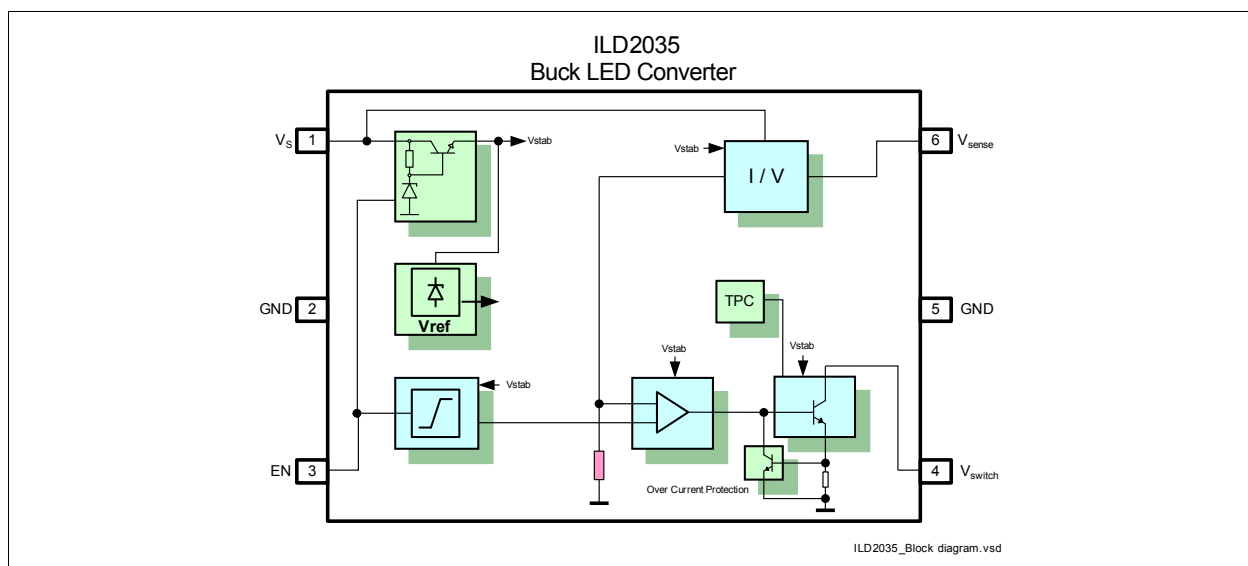

Figure 1 Block Diagram

Pin Definition

Table 1 Pin Definition and Function

Pin No.	Name	Pin Type	Buffer Type	Function
1	V_s	Input	–	Supply voltage
2	GND	GND	–	IC ground
3	EN	Input	–	Chip enable signal
4	V_{switch}	Output	–	Power switch output
5	GND	GND	–	IC ground
6	V_{sense}	Input	–	LED current sense input

3 Maximum Ratings

Table 2 Maximum Ratings

Parameter	Symbol	Values			Unit	Note / Test Condition
		Min.	Typ.	Max.		
Supply voltage	V_S	–	–	24	V	–
Peak output current	I_{Switch}	–	–	550	mA	Hysteretic peak current
Total power dissipation, $T_s \leq 85^\circ\text{C}$	P_{tot}	–	–	1000	mW	–
Junction temperature	T_J	–	–	150	$^\circ\text{C}$	–
Solder temperature of GND pins	T_{SGND}	–	–	125	$^\circ\text{C}$	–
Storage temperature range	T_{STG}	-65	–	150	$^\circ\text{C}$	–
ESD capability at all pins	$V_{ESD\ HBM}$	–	–	4	kV	HBM acc. to JESD22-A114

Attention: Stresses above the max. values listed here may cause permanent damage to the device. Exposure to absolute maximum rating conditions for extended periods may affect device reliability. Maximum ratings are absolute ratings; exceeding only one of these values may cause irreversible damage to the integrated circuit.

4 Thermal Characteristics

Table 3 Maximum Thermal Resistance

Parameter	Symbol	Values			Unit	Note / Test Condition
		Min.	Typ.	Max.		
Junction - soldering point ¹⁾	R_{thJS}	–	–	65	K/W	–

1) For calculation of R_{thJA} please refer to application note AN077 (Thermal Resistance Calculation)

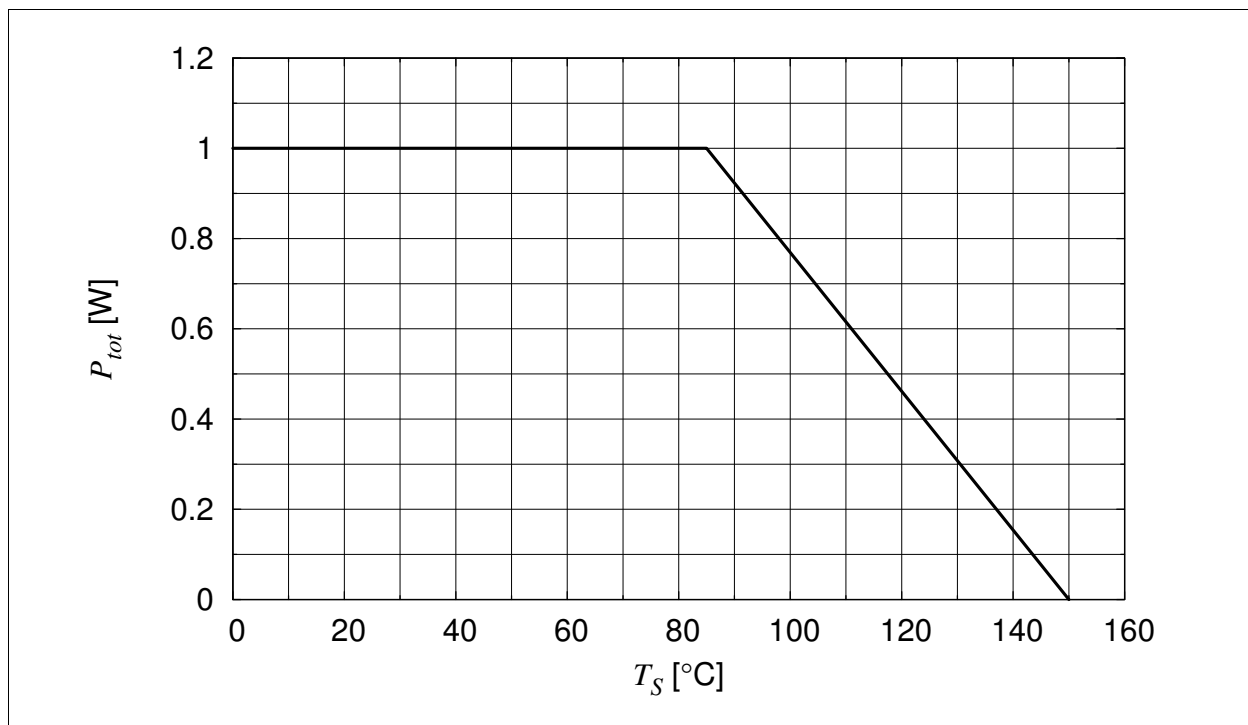

Figure 2 Total Power Dissipation

Equation (1) gives an estimation for the power dissipation of ILD2035.

$$P_{tot} = 1.1V \cdot I_{LED} \cdot duty\ cycle + f_{Switch} \cdot 1\ \mu W \cdot \frac{I_{LED}}{350\ mA} \quad (1)$$

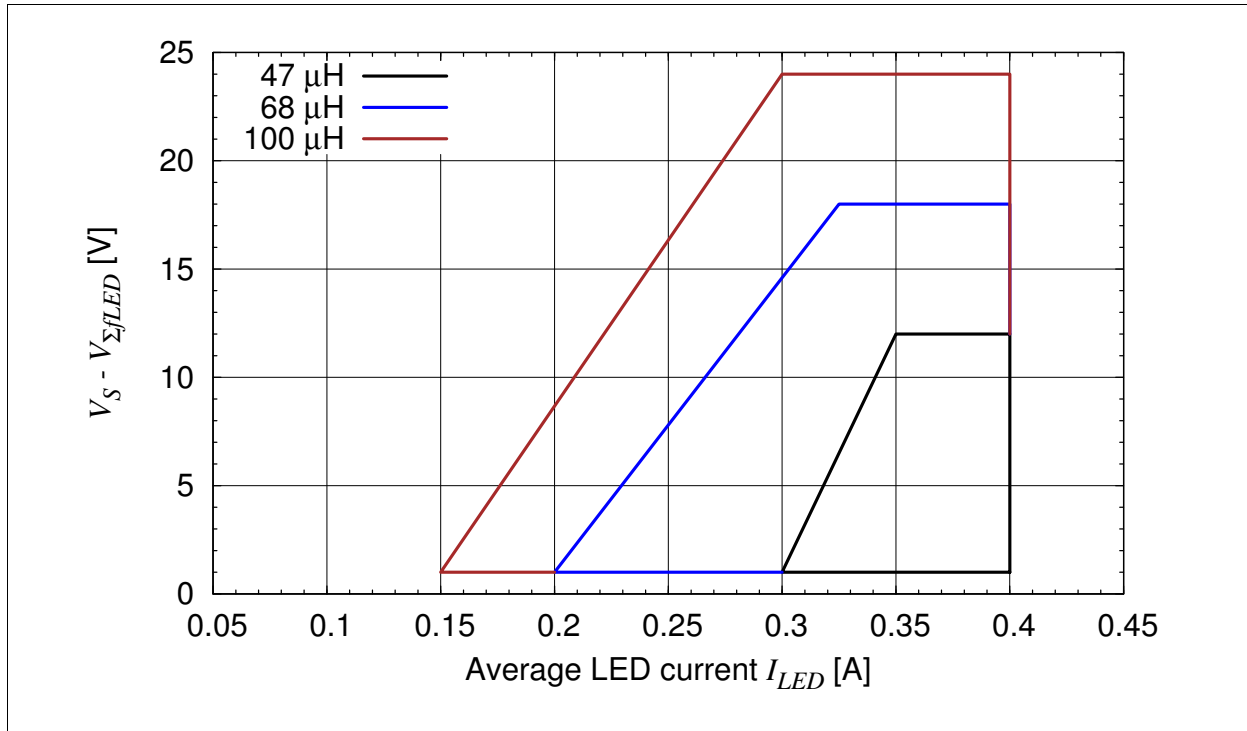

Figure 3 Safe Operating Area

Figure 2 shows the safe operating area for the respective inductance values. The safe operating area consists of the minimum and maximum allowed average LED current and the resulting voltage overhead. The voltage overhead $V_{overhead}$ is the difference between the supply voltage V_S and the sum of the LED forward voltages $V_{\Sigma JLED}$.

Example calculation

3 LEDs in series, $V_{JLED} = 3V$, $I_{LED} = 350$ mA, $V_S = 12$ V

$$V_{overhead} = V_S - V_{\Sigma JLED} = 12\text{ V} - 9\text{ V} = 3\text{ V}$$

→ any of the above coil values can be used

Outside the safe operating area the switching frequency, hysteretic peak current and associated power dissipation P_{tot} of ILD2035 will increase beyond the maximum ratings.

5 Electrical Characteristics

5.1 DC Characteristics

All parameters at $T_A = 25\text{ °C}$, unless otherwise specified.

$V_S = 12\text{ V}$, 3 LEDs, $R_{sense} = 303\text{ m}\Omega$ ($I_{LED} = 375\text{ mA}$), $L = 100\text{ }\mu\text{H}$, $V_{EN} = 12\text{ V}$, $V_{JLED} = 3\text{ V}$

Table 4 DC Characteristics

Parameter	Symbol	Values			Unit	Note / Test Condition
		Min.	Typ.	Max.		
Supply voltage	V_S	8	–	22	V	
Overall current consumption open load	$I_{S\text{ open load}}$	–	2.4	–	mA	$V_S = 12\text{ V}$ $I_{LED} = 0\text{ mA}$
Overall standby current consumption	$I_{S\text{ standby}}$	–	–	1	μA	$V_{EN} = 0\text{ V}$; $V_S = 12\text{ V}$
Current of Sense input	I_{sense}	–	20	–	μA	at any LED current
Enable voltage for standby mode	$V_{EN,Off}$	-0.3	–	0.4	V	
Enable voltage for power on	$V_{EN,On}$	2.5	3	22	V	full LED current
Min. power on puls duration	$t_{EN,On}$	10	–	–	μs	
Input current of enable pin	I_{EN}	–	310	–	μA	$V_{EN} = 12\text{ V}$
Over temperature protection	$T_{S, TSD}$	–	113	–	$^{\circ}\text{C}$	T_S for 10 % I_{LED} reduction, defined by T_J

5.2 Switching Characteristics

All parameters at $T_A = 25\text{ }^\circ\text{C}$, unless otherwise specified.

$V_S = 12\text{ V}$, 3 LEDs, $R_{sense} = 303\text{ m}\Omega$ ($I_{LED} = 375\text{ mA}$), $L = 100\text{ }\mu\text{H}$, $V_{EN} = 12\text{ V}$, $V_{JLED} = 3\text{ V}$

Table 5 Switching Characteristics

Parameter	Symbol	Values			Unit	Note / Test Condition
		Min.	Typ.	Max.		
Switching frequency	f_{Switch}	–	120	–	kHz	
Maximum switching frequency	$f_{Switch\ max}$	–	–	500	kHz	for any coil value
Mean current sense threshold voltage	V_{sense}	–	114	–	mV	
Sense threshold hysteresis	$V_{sensehys}$	–	± 7.5	–	%	
Residual voltage at collector of power transistor	$V_{switch\ on}$	–	1.1	–	V	output switch turned on
Output current accuracy	I_{outacc}	–	± 3	–	%	

5.3 Digital Signals

All parameters at $T_A = 25\text{ }^\circ\text{C}$, unless otherwise specified.

Table 6 Digital Control Parameter at Pin EN

Parameter	Symbol	Values			Unit	Note / Test Condition
		Min.	Typ.	Max.		
Input voltage for power on	V_{On}	2.5	3	22	V	full LED current
Input voltage for power off	V_{Off}	-0.3	–	0.4	V	
Min. power on puls duration	t_{On}	10	–		μs	

6 Basic Application Information

This section covers the basic information required for calculating the parameters for a certain LED application. For detailed application information please visit our web site <http://www.infineon.com/led.apnotes>

6.1 Setting the average LED current

The average output current for the LEDs is set by the external sense resistor R_{sense} . To calculate the value of this resistor a first approximation can be calculated using [Equation \(2\)](#).

V_{sense} is dependent on the supply voltage V_S and the number of LEDs in series.

$$R_{sense} = \frac{V_{sense}}{I_{LED}} \quad (2)$$

Example calculation

$V_S = 12 \text{ V}$, $100 \mu\text{H}$, $V_{JLED} = 3 \text{ V}$, 3 LEDs in series

→ $V_{sense} = 114 \text{ mV}$

$I_{LED} = 375 \text{ mA}$

→ $R_{sense} = 303 \text{ m}\Omega$

An easy way to achieve these resistor values is to connect standard resistors in parallel.

6.1.1 Temperature Protection Circuit

ILD2035 incorporates a temperature protection circuit referring to the junction temperature of the IC. The higher the junction temperature the lower the current of the LEDs. This feature helps to reduce the power dissipation of ILD2035 and the LEDs. Yet still the product specific maximum ratings for the junction temperature need to be observed to avoid a permanent damage of the devices.

ILD2035 has been characterized on ILD4035/4001 application board heated from the backside without additional air flow on the circuit board surface besides natural convection. The size and layout of the circuit board as well as the air flow around it influence the thermal resistance junction to ambient R_{thJA} of ILD2035 and thus its junction temperature. Below figures show the LED current versus soldering point temperature T_S .

LED current versus T_S , $V_S = 12\text{ V}$

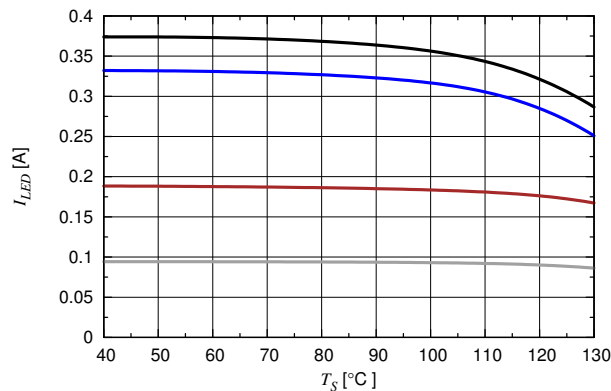

303 mΩ, 100 μH 600 mΩ, 100 μH 333 mΩ, 100 μH
333 mΩ, 100 μH 1200 mΩ, 220 μH 333 mΩ, 100 μH

LED current (relative) versus T_S , $V_S = 12\text{ V}$

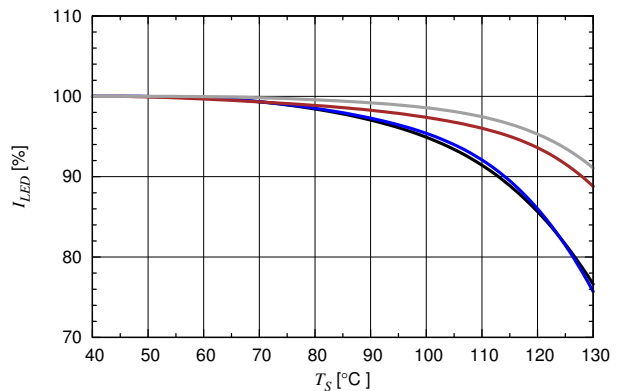

303 mΩ, 100 μH 600 mΩ, 100 μH 333 mΩ, 100 μH
333 mΩ, 100 μH 1200 mΩ, 220 μH 333 mΩ, 100 μH

6.2 Switching Parameters

For all shown parameters ILD2035 has been measured at $T_A = 25\text{ °C}$. Used LEDs have a typical V_{fLED} of 3 V.

$R_{sense} = 303 \text{ m}\Omega$, $L = 47 \text{ }\mu\text{H}$

I_{LED} versus V_S and Number of LEDs

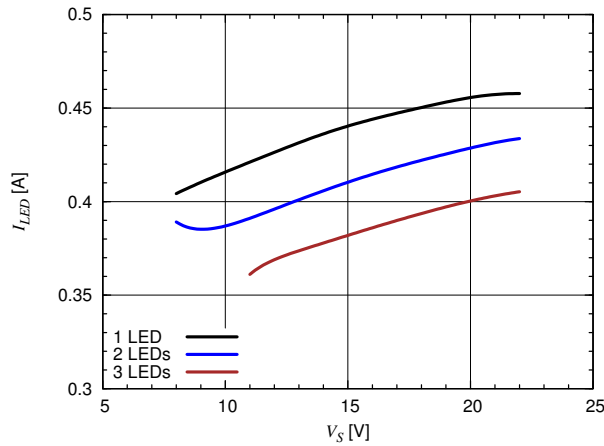

f_{Switch} versus V_S and Number of LEDs

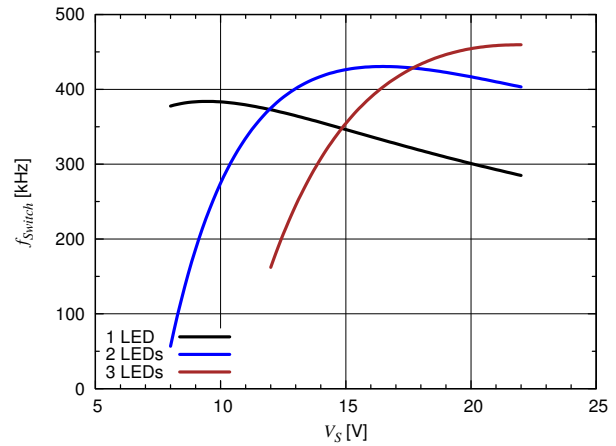

Efficiency versus V_S and Number of LEDs

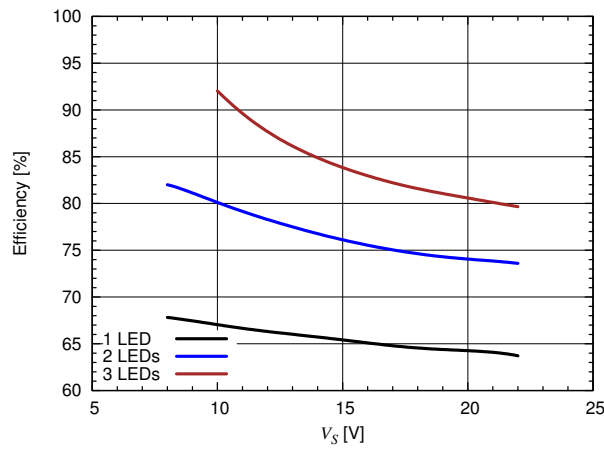

Duty Cycle versus V_S and Number of LEDs

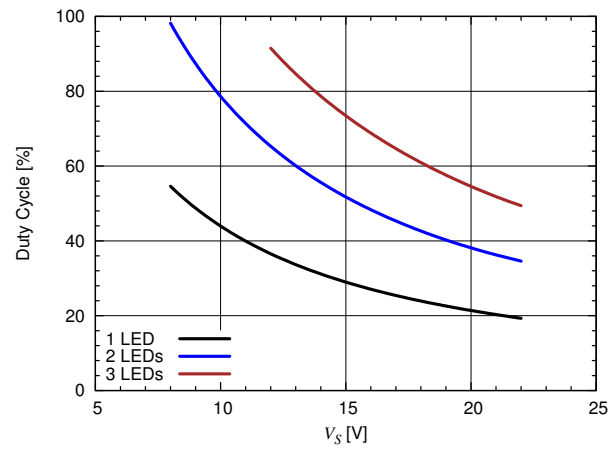

$R_{\text{sense}} = 303 \text{ m}\Omega$, $L = 68 \text{ }\mu\text{H}$

I_{LED} versus V_{S} and Number of LEDs

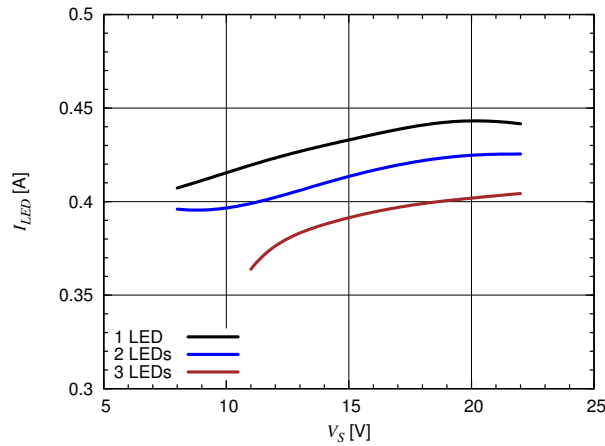

f_{Switch} versus V_{S} and Number of LEDs

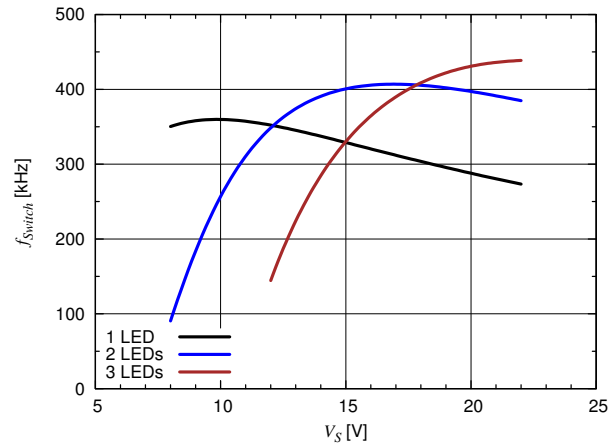

Efficiency versus V_{S} and Number of LEDs

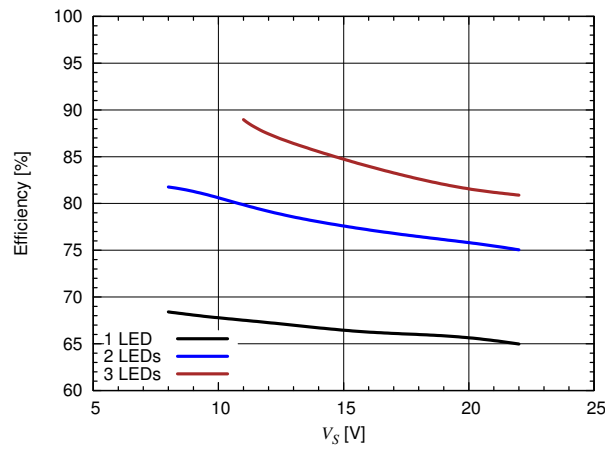

Duty Cycle versus V_{S} and Number of LEDs

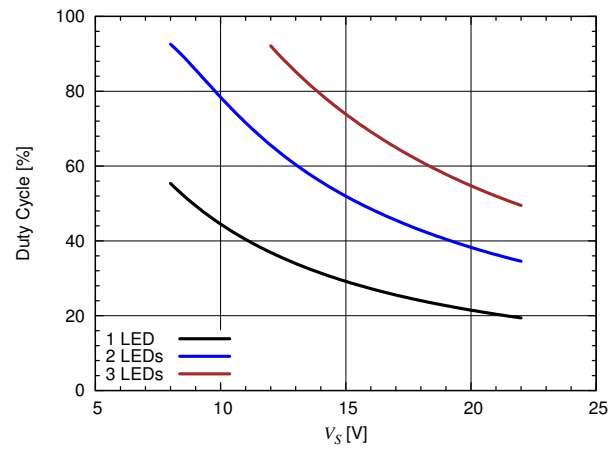

$R_{\text{sense}} = 303 \text{ m}\Omega$, $L = 100 \text{ }\mu\text{H}$

I_{LED} versus V_{S} and Number of LEDs

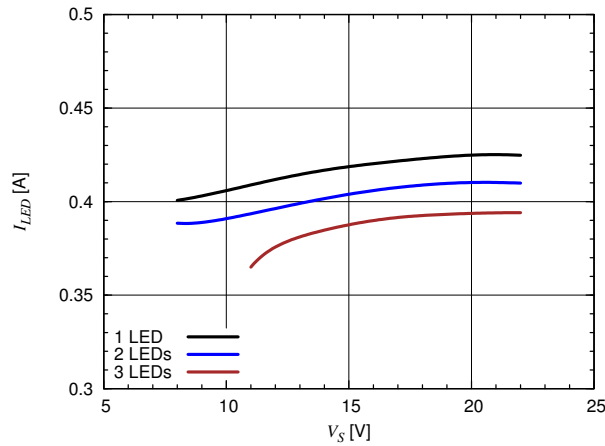

f_{Switch} versus V_{S} and Number of LEDs

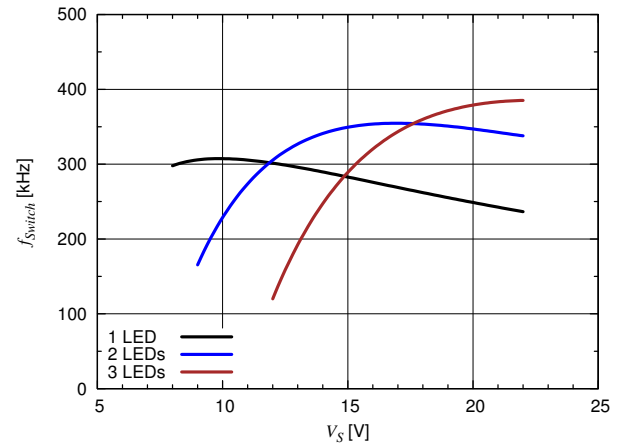

Efficiency versus V_{S} and Number of LEDs

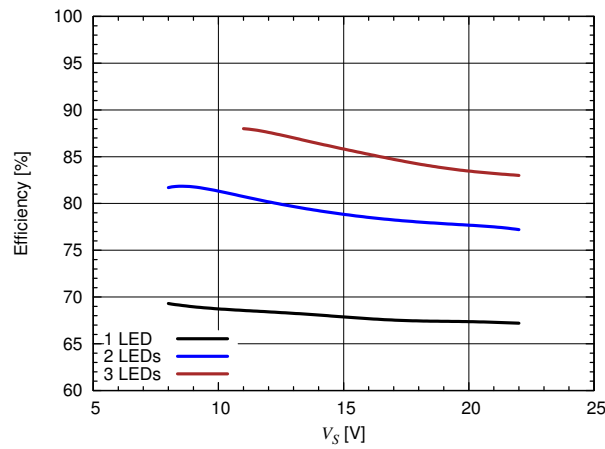

Duty Cycle versus V_{S} and Number of LEDs

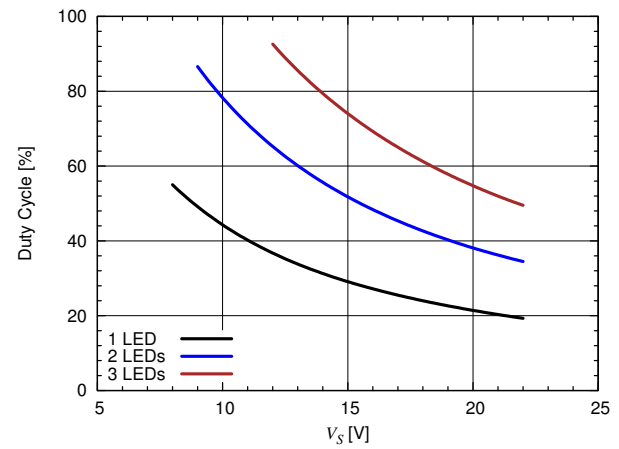

$R_{\text{sense}} = 367 \text{ m}\Omega$, $L = 47 \text{ }\mu\text{H}$

I_{LED} versus V_{S} and Number of LEDs

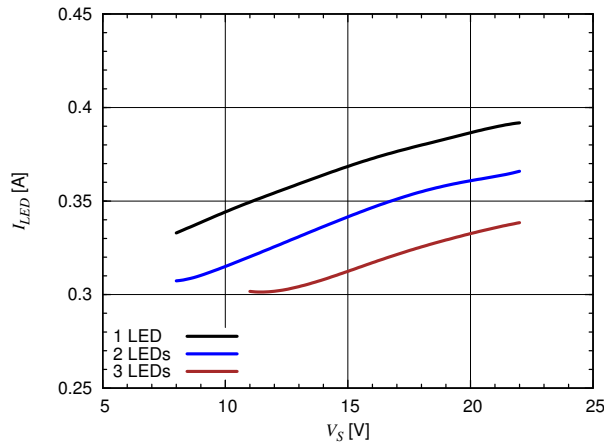

f_{Switch} versus V_{S} and Number of LEDs

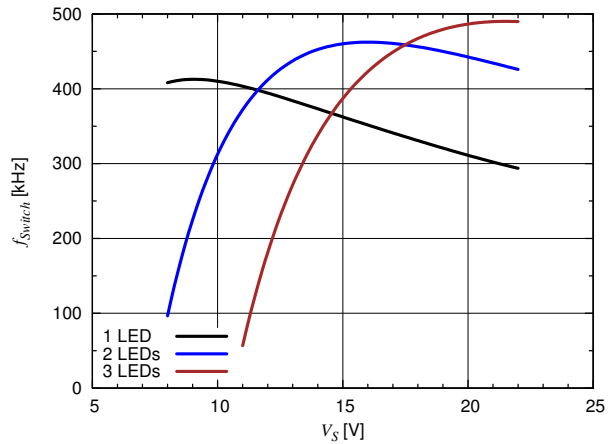

Efficiency versus V_{S} and Number of LEDs

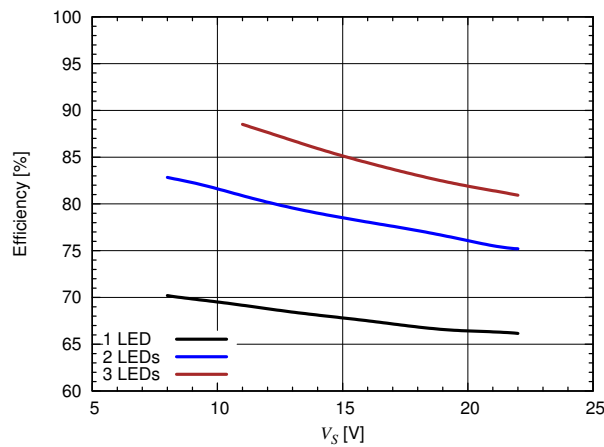

Duty Cycle versus V_{S} and Number of LEDs

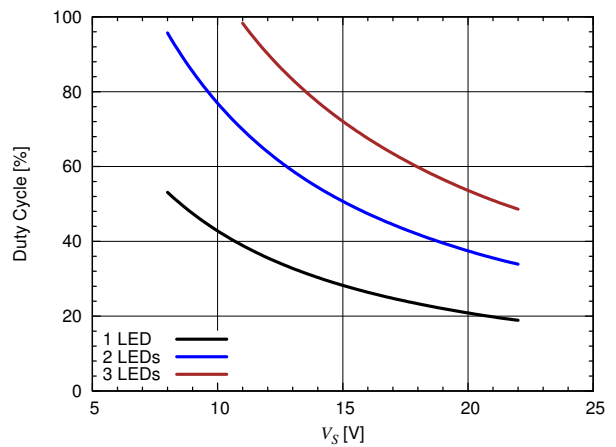

$R_{\text{sense}} = 367 \text{ m}\Omega$, $L = 68 \text{ }\mu\text{H}$

I_{LED} versus V_{S} and Number of LEDs

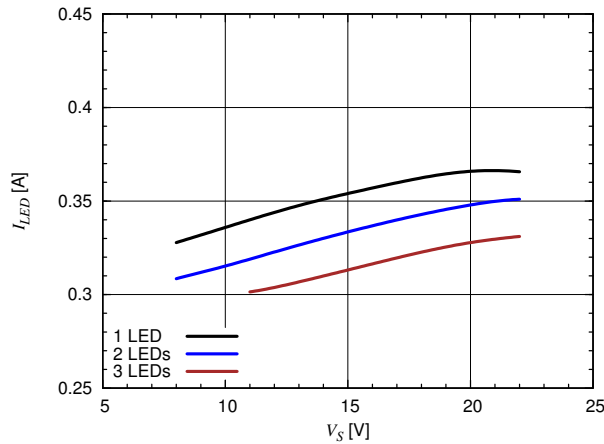

f_{Switch} versus V_{S} and Number of LEDs

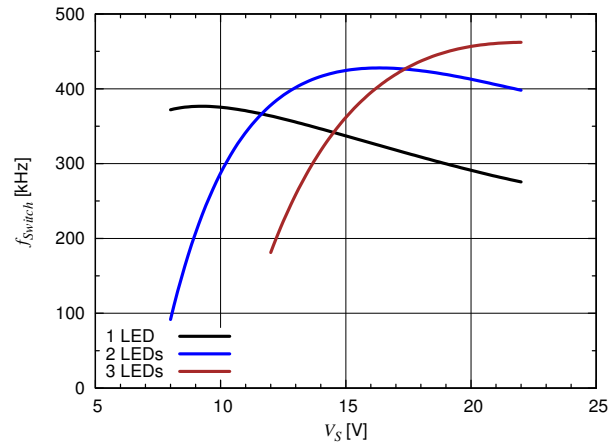

Efficiency versus V_{S} and Number of LEDs

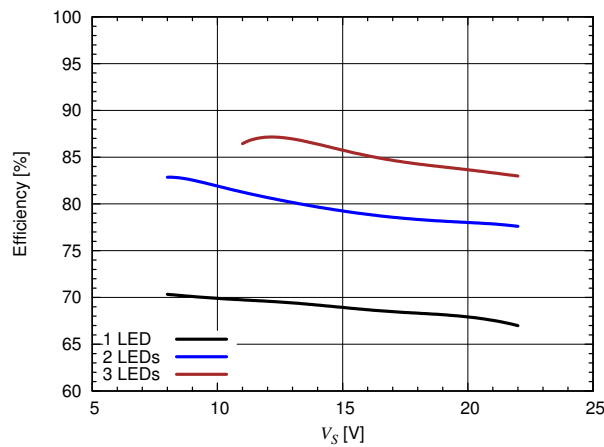

Duty Cycle versus V_{S} and Number of LEDs

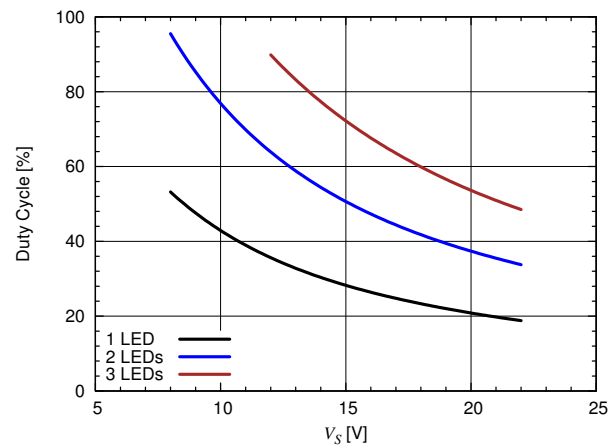

$R_{\text{sense}} = 367 \text{ m}\Omega$, $L = 100 \text{ }\mu\text{H}$

I_{LED} versus V_{S} and Number of LEDs

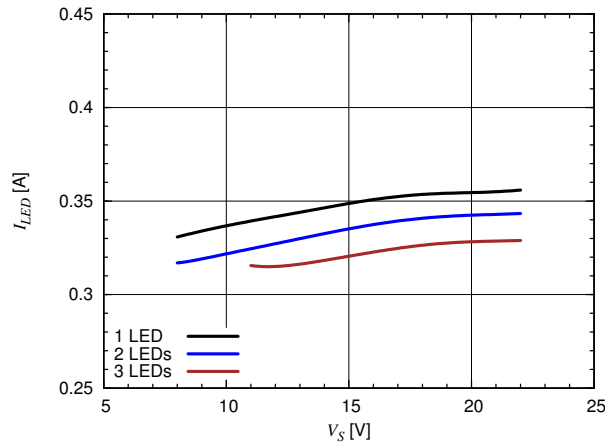

f_{Switch} versus V_{S} and Number of LEDs

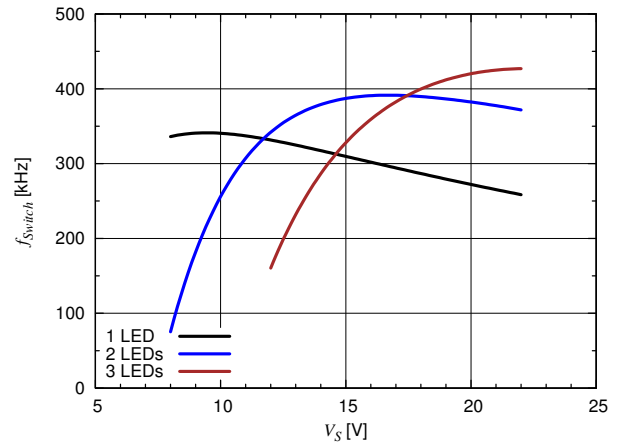

Efficiency versus V_{S} and Number of LEDs

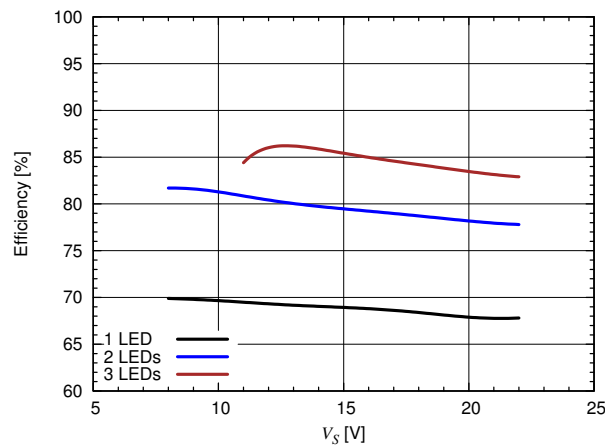

Duty Cycle versus V_{S} and Number of LEDs

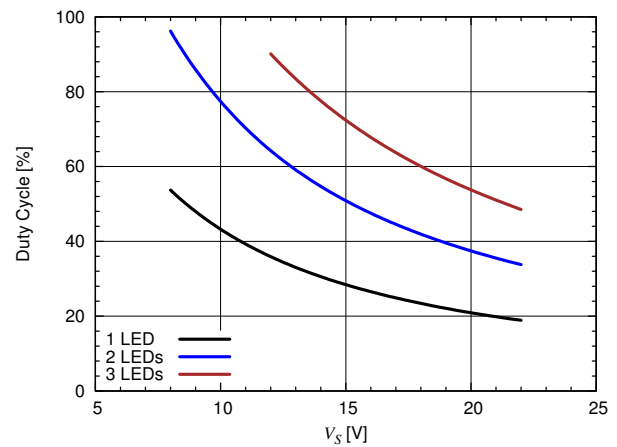

7 Application Circuit

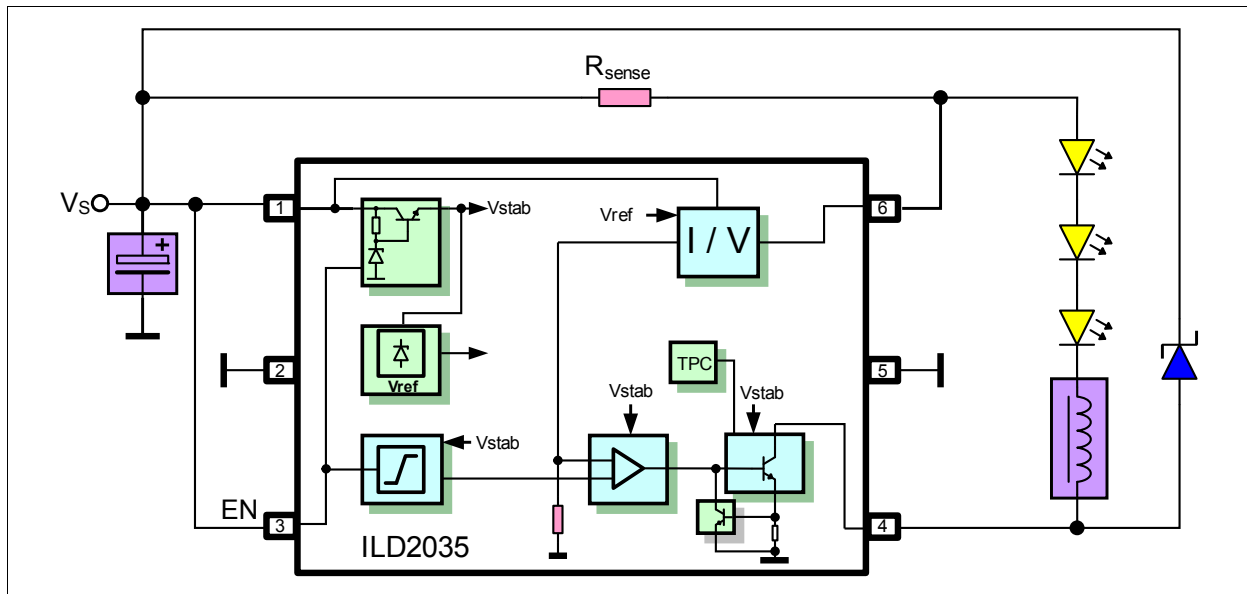

Figure 4 Application Circuit

7.1 Evaluation Board

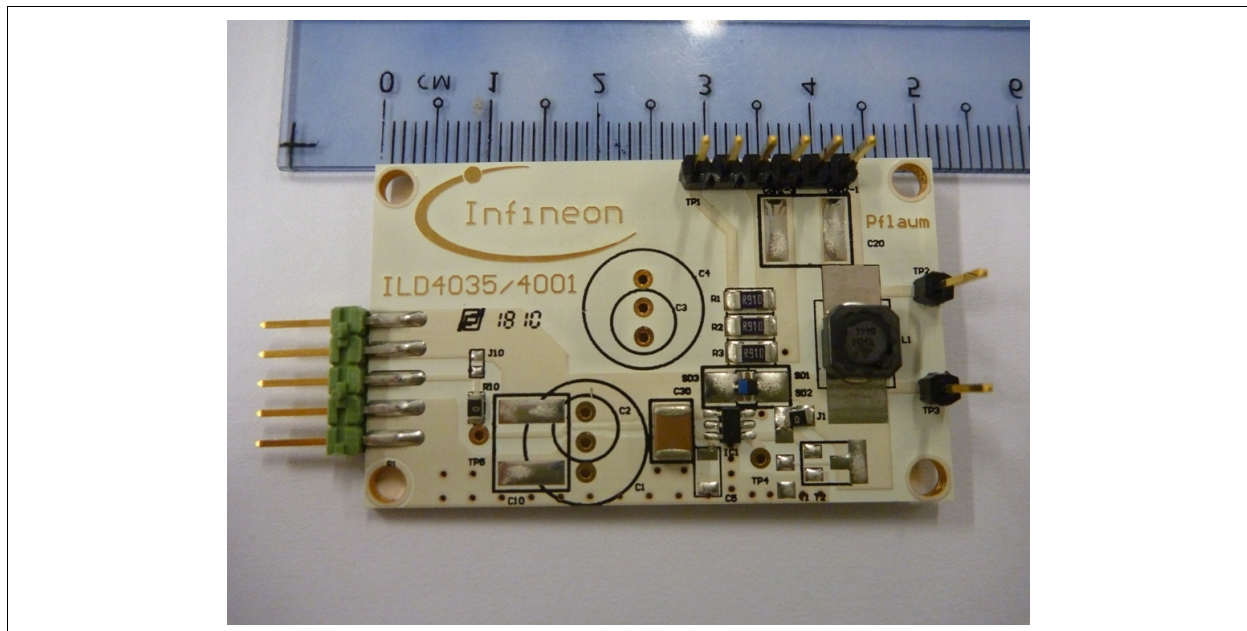

Figure 5 ILD2035 on Evaluation Board

8 Package Information

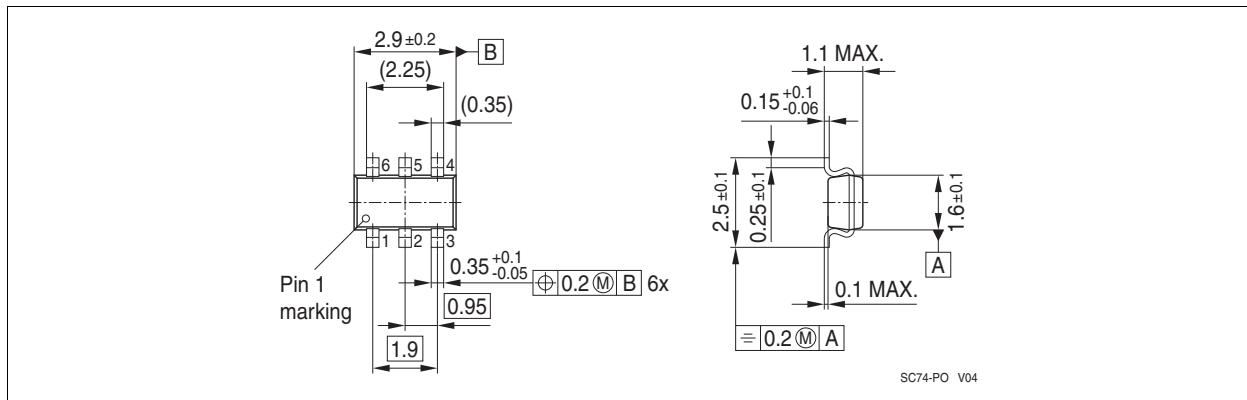

Figure 6 Package Outline SC74

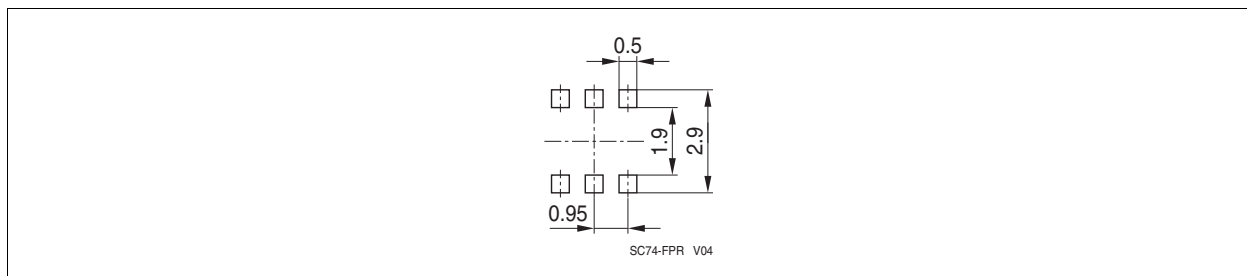

Figure 7 Recommended PCB Footprint for Reflow Soldering

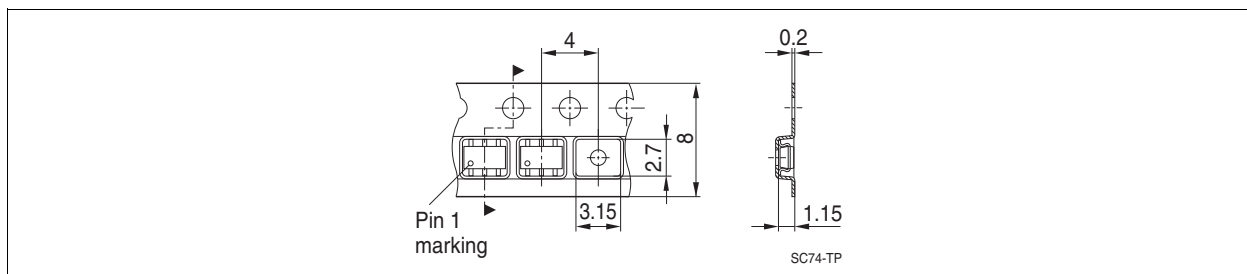

Figure 8 Tape Loading

www.infineon.com

Published by Infineon Technologies AG