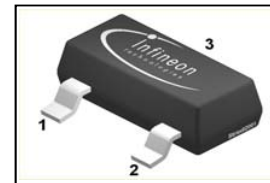
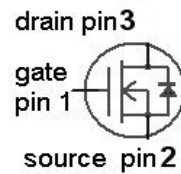

SIPMOS® Small-Signal-Transistor
Features

- N-channel
- Depletion mode
- dv/dt rated
- Available with $V_{GS(th)}$ indicator on reel
- Pb-free lead plating; RoHS compliant
- Qualified according to AEC Q101
- Halogen-free according to IEC61249-2-21

Product Summary

V_{DS}	600	V
$R_{DS(on),max}$	700	Ω
$I_{DSS,min}$	0.007	A

PG-SOT-23

Type	Package	Pb-free	Tape and Reel Information	Marking
BSS126	PG-SOT-23	Yes	H6327: 3000 pcs/reel	SHs
BSS126	PG-SOT-23	Yes	H6906: 3000 pcs/reel sorted in $V_{GS(th)}$ bands ¹⁾	SHs

Maximum ratings, at $T_j=25\text{ °C}$, unless otherwise specified

Parameter	Symbol	Conditions	Value	Unit
Continuous drain current	I_D	$T_A=25\text{ °C}$	0.021	A
		$T_A=70\text{ °C}$	0.017	
Pulsed drain current	$I_{D,pulse}$	$T_A=25\text{ °C}$	0.085	
Reverse diode dv/dt	dv/dt	$I_D=0.016\text{ A}$, $V_{DS}=20\text{ V}$, $di/dt=200\text{ A}/\mu\text{s}$, $T_{j,max}=150\text{ °C}$	6	kV/ μs
Gate source voltage	V_{GS}		± 20	V
ESD sensitivity (HBM) as per JESD22-A114			0 (>0 V to >250 V)	
Power dissipation	P_{tot}	$T_A=25\text{ °C}$	0.50	W
Operating and storage temperature	T_j, T_{stg}		-55 ... 150	$^{\circ}\text{C}$
IEC climatic category; DIN IEC 68-1			55/150/56	

¹⁾ see table on next page and diagram 11

Parameter	Symbol	Conditions	Values			Unit
			min.	typ.	max.	

Thermal characteristics

Thermal resistance, junction - ambient	R_{thJA}	minimal footprint	-	-	250	K/W
--	------------	-------------------	---	---	-----	-----

Electrical characteristics, at $T_j=25\text{ }^\circ\text{C}$, unless otherwise specified
Static characteristics

Drain-source breakdown voltage	$V_{(BR)DSS}$	$V_{GS}=-5\text{ V}, I_D=250\text{ }\mu\text{A}$	600	-	-	V
Gate threshold voltage	$V_{GS(th)}$	$V_{DS}=3\text{ V}, I_D=8\text{ }\mu\text{A}$	-2.7	-2.0	-1.6	
Drain-source cutoff current	$I_{D(off)}$	$V_{DS}=600\text{ V}, V_{GS}=-5\text{ V}, T_j=25\text{ }^\circ\text{C}$	-	-	0.1	μA
		$V_{DS}=600\text{ V}, V_{GS}=-5\text{ V}, T_j=125\text{ }^\circ\text{C}$	-	-	10	
Gate-source leakage current	I_{GSS}	$V_{GS}=20\text{ V}, V_{DS}=0\text{ V}$	-	-	100	nA
On-state drain current	I_{DSS}	$V_{GS}=0\text{ V}, V_{DS}=25\text{ V}$	7	-	-	mA
Drain-source on-state resistance	$R_{DS(on)}$	$V_{GS}=0\text{ V}, I_D=3\text{ mA}$	-	320	700	Ω
		$V_{GS}=10\text{ V}, I_D=16\text{ mA}$	-	280	500	
Transconductance	g_{fs}	$ V_{DS} >2 I_D R_{DS(on)max}, I_D=0.01\text{ A}$	0.008	0.017	-	S

Threshold voltage $V_{GS(th)}$ sorted in bands²⁾

J	$V_{GS(th)}$	$V_{DS}=3\text{ V}, I_D=8\text{ }\mu\text{A}$	-1.8	-	-1.6	V
K			-1.95	-	-1.75	
L			-2.1	-	-1.9	
M			-2.25	-	-2.05	
N			-2.4	-	-2.2	

²⁾ Each reel contains transistors out of one band whose identifying letter is printed on the reel label. A specific band cannot be ordered separately.

Parameter	Symbol	Conditions	Values			Unit
			min.	typ.	max.	

Dynamic characteristics

$I_D=f(V_{GS}); V_{DS}=3\text{ V}; T_j=25\text{ °C}$	C_{iss}	$V_{GS}=-5\text{ V}, V_{DS}=25\text{ V}, f=1\text{ MHz}$	-	21	28	pF
Output capacitance	C_{oss}		-	2.4	3.2	
Reverse transfer capacitance	C_{rss}		-	1.0	1.5	
Turn-on delay time	$t_{d(on)}$	$V_{DD}=300\text{ V}, V_{GS}=-3\dots 7\text{ V}, I_D=0.01\text{ A}, R_G=6\text{ }\Omega$	-	6.1	9.2	ns
Rise time	t_r		-	9.7	14.5	
Turn-off delay time	$t_{d(off)}$		-	14	21	
Fall time	t_f		-	115	170	

Gate Charge Characteristics

Gate to source charge	Q_{gs}	$V_{DD}=400\text{ V}, I_D=10\text{ mA}, V_{GS}=-3\text{ to }5\text{ V}$	-	0.05	0.08	nC
Gate to drain charge	Q_{gd}		-	1.2	1.8	
Gate charge total	Q_g		-	1.4	2.1	
Gate plateau voltage	$V_{plateau}$		-	0.10	-	V

Reverse Diode

Diode continuous forward current	I_S	$T_A=25\text{ °C}$	-	-	0.016	A
Diode pulse current	$I_{S,pulse}$		-	-	0.064	
Diode forward voltage	V_{SD}	$V_{GS}=-5\text{ V}, I_F=16\text{ mA}, T_j=25\text{ °C}$	-	0.81	1.2	V
Reverse recovery time	t_{rr}	$V_R=300\text{ V}, I_F=0.01\text{ A}, di_F/dt=100\text{ A}/\mu\text{s}$	-	160	240	ns
Reverse recovery charge	Q_{rr}		-	13.2	19.8	nC

1 Power dissipation

$P_{tot}=f(T_A)$

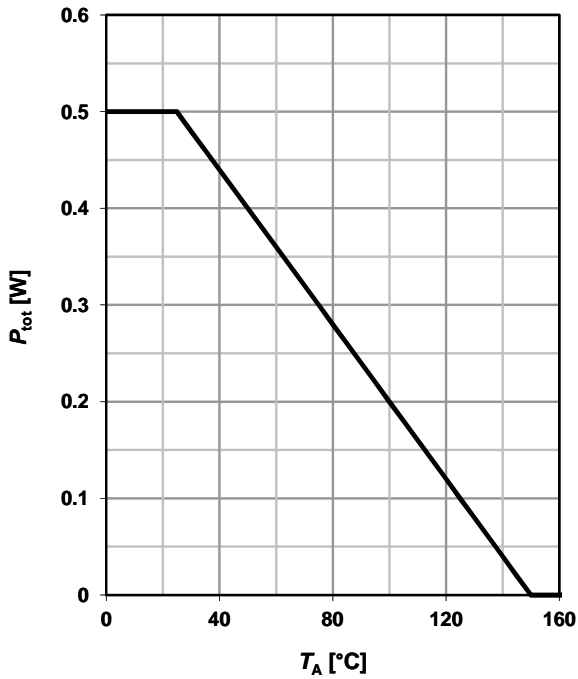

2 Drain current

$I_D=f(T_A); V_{GS} \geq 10\text{ V}$

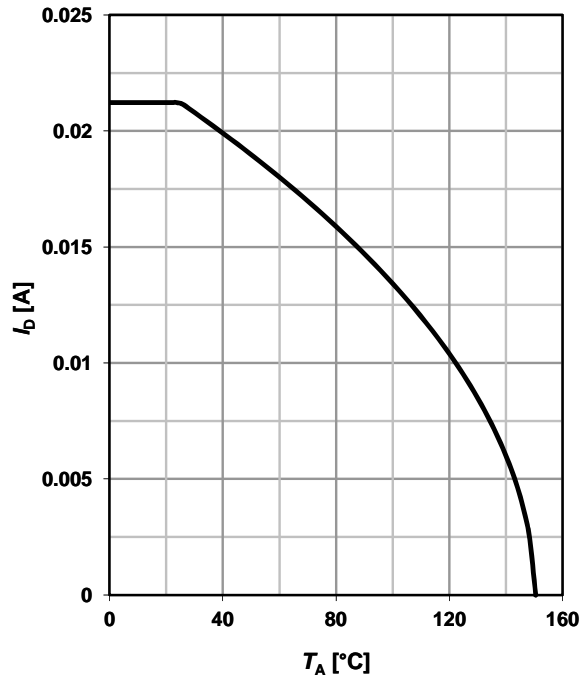

3 Safe operating area

$I_D=f(V_{GS}); V_{DS}=3\text{ V}; T_J=25\text{ °C}$

parameter: t_p

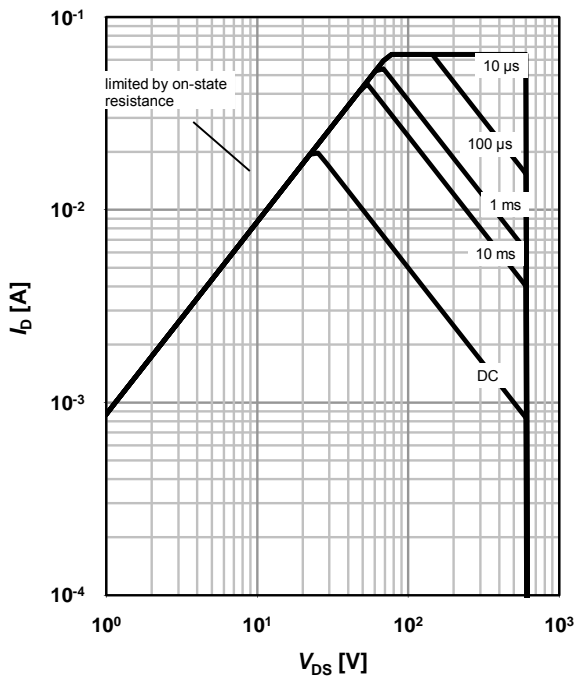

4 Max. transient thermal impedance

$Z_{thJA}=f(t_p)$

parameter: $D=t_p/T$

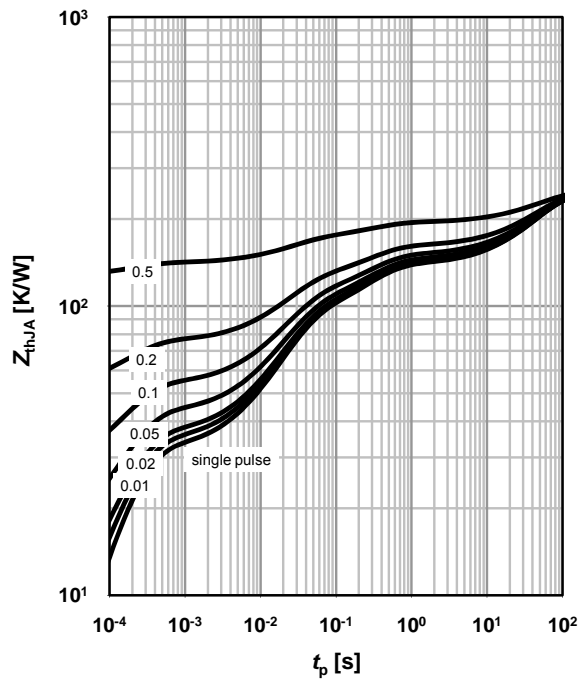

5 Typ. output characteristics

$I_D = f(V_{DS}); T_j = 25\text{ }^\circ\text{C}$

parameter: V_{GS}

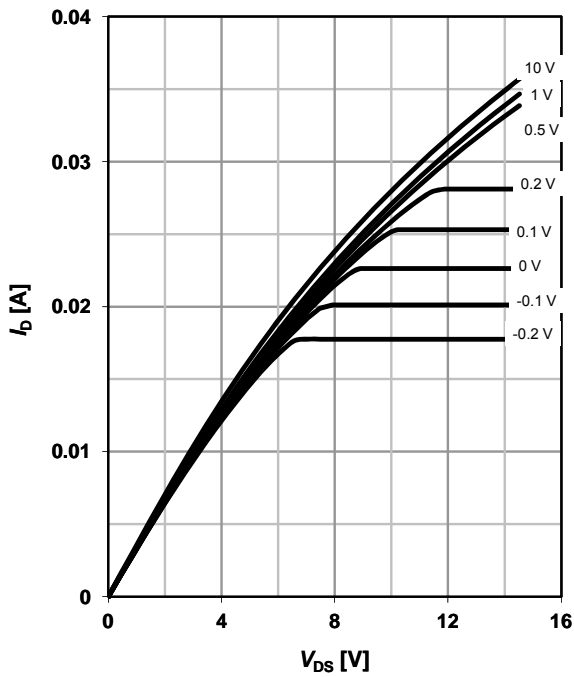

6 Typ. drain-source on resistance

$R_{DS(on)} = f(I_D); T_j = 25\text{ }^\circ\text{C}$

parameter: V_{GS}

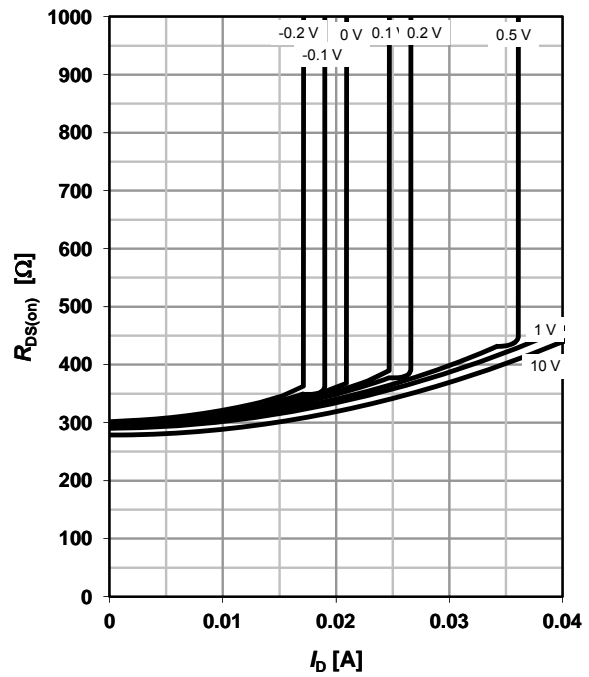

7 Typ. transfer characteristics

$I_D = f(V_{GS}); V_{DS} = 3\text{ V}; T_j = 25\text{ }^\circ\text{C}$

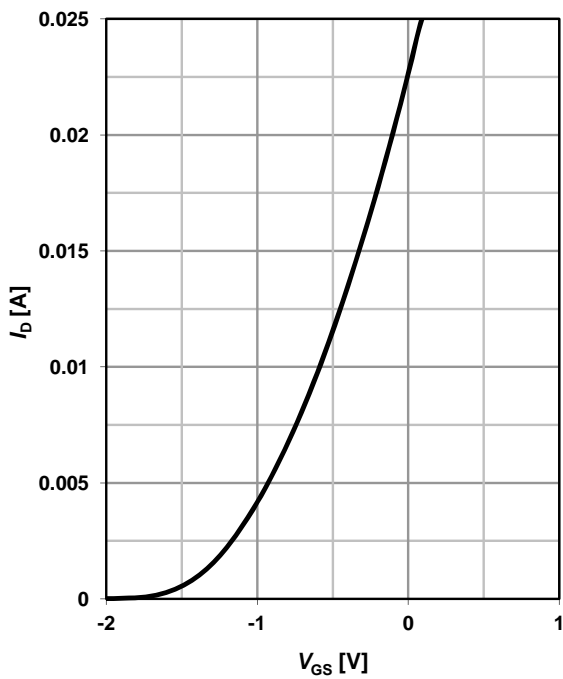

8 Typ. forward transconductance

$g_{fs} = f(I_D); T_j = 25\text{ }^\circ\text{C}$

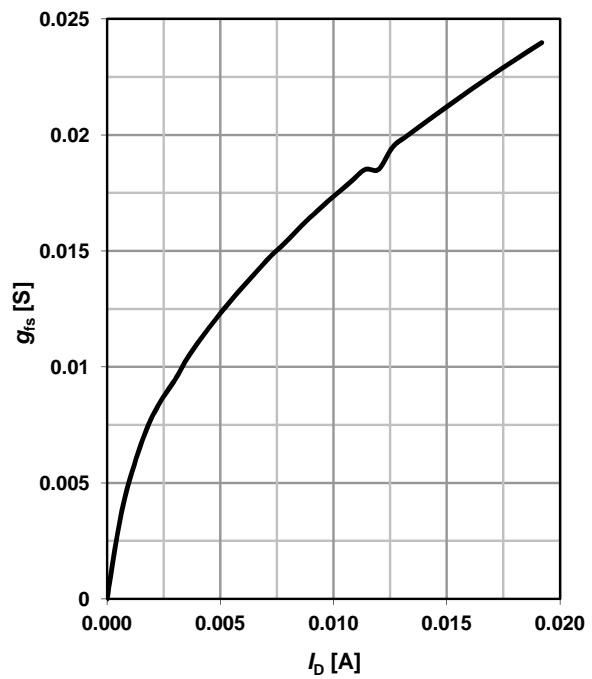

9 Drain-source on-state resistance

$R_{DS(on)} = f(T_j); I_D = 0.016 \text{ mA}; V_{GS} = 0 \text{ V}$

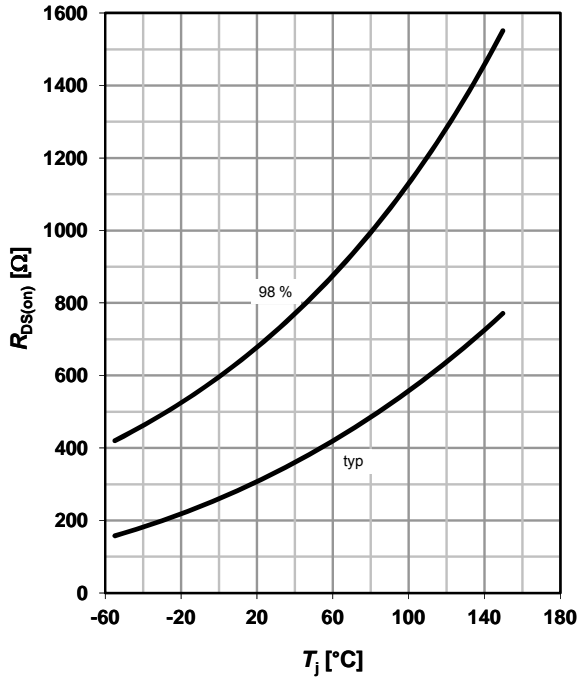

10 Typ. gate threshold voltage

$V_{GS(th)} = f(T_j); V_{DS} = 3 \text{ V}; I_D = 8 \mu\text{A}$

parameter: I_D

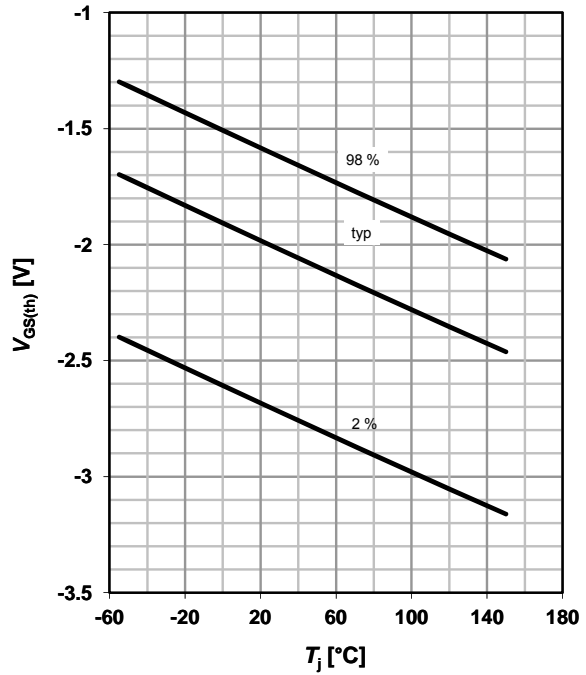

11 Threshold voltage bands

$I_D = f(V_{GS}); V_{DS} = 3 \text{ V}; T_j = 25 \text{ °C}$

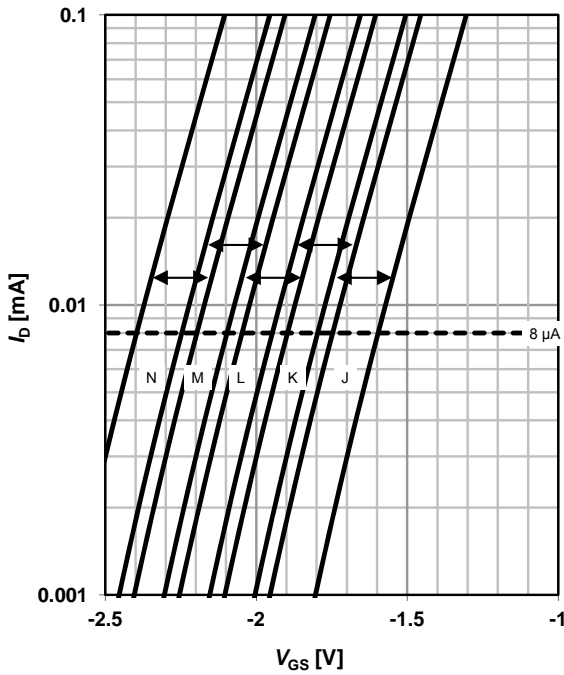

12 Typ. capacitances

$C = f(V_{DS}); V_{GS} = -3 \text{ V}; f = 1 \text{ MHz}$

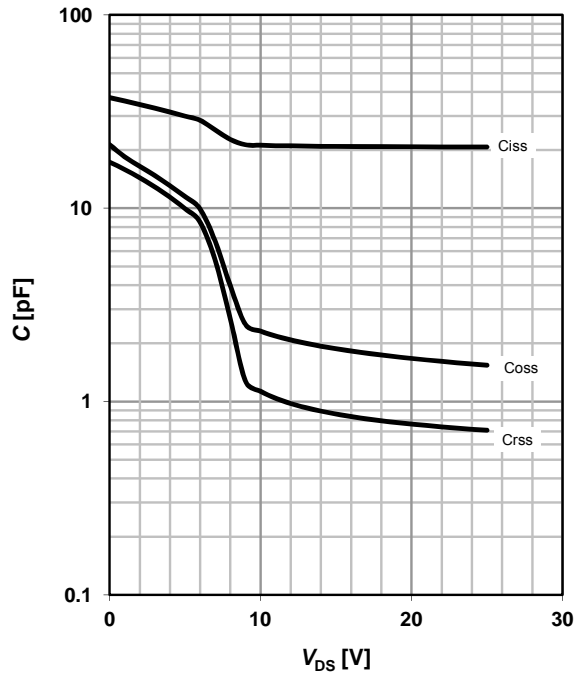

13 Forward characteristics of reverse diode

$$I_F = f(V_{SD})$$

parameter: T_j

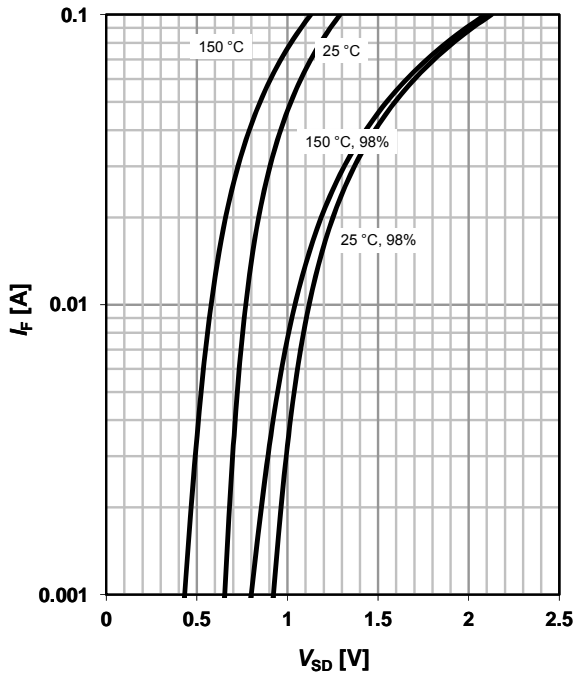

15 Typ. gate charge

$$V_{GS} = f(Q_{gate}); I_D = 0.1 \text{ A pulsed}$$

parameter: V_{DD}

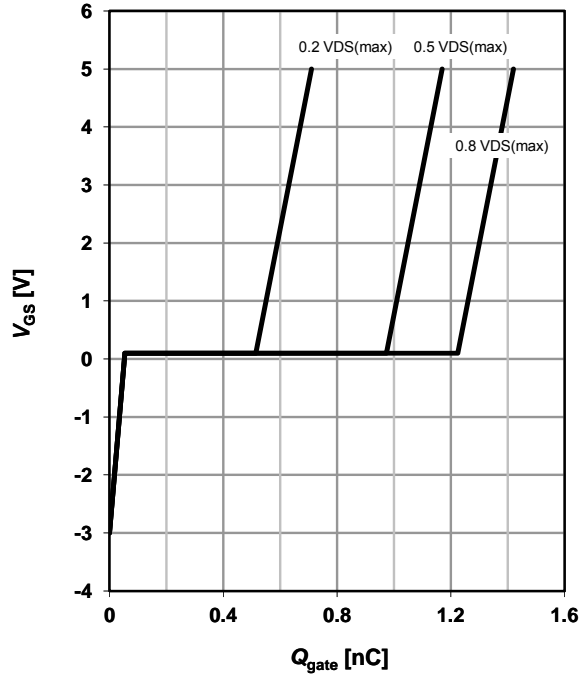

16 Drain-source breakdown voltage

$$I_D = f(V_{GS}); V_{DS} = 3 \text{ V}; T_j = 25 \text{ °C}$$

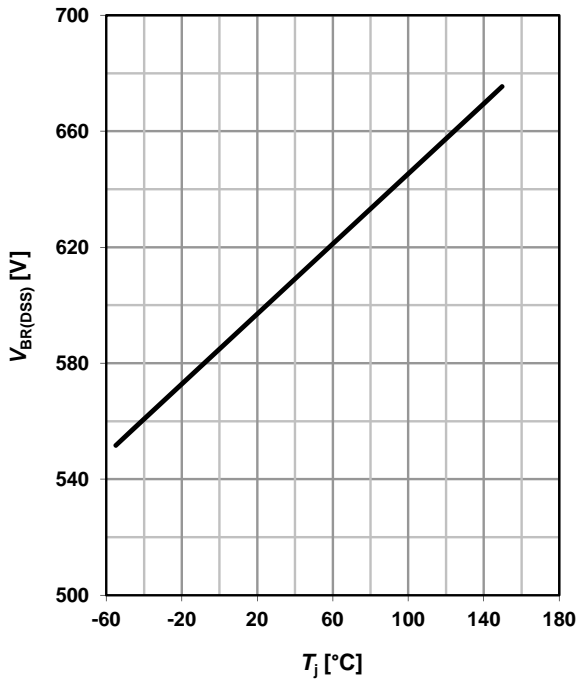

Package Outline:

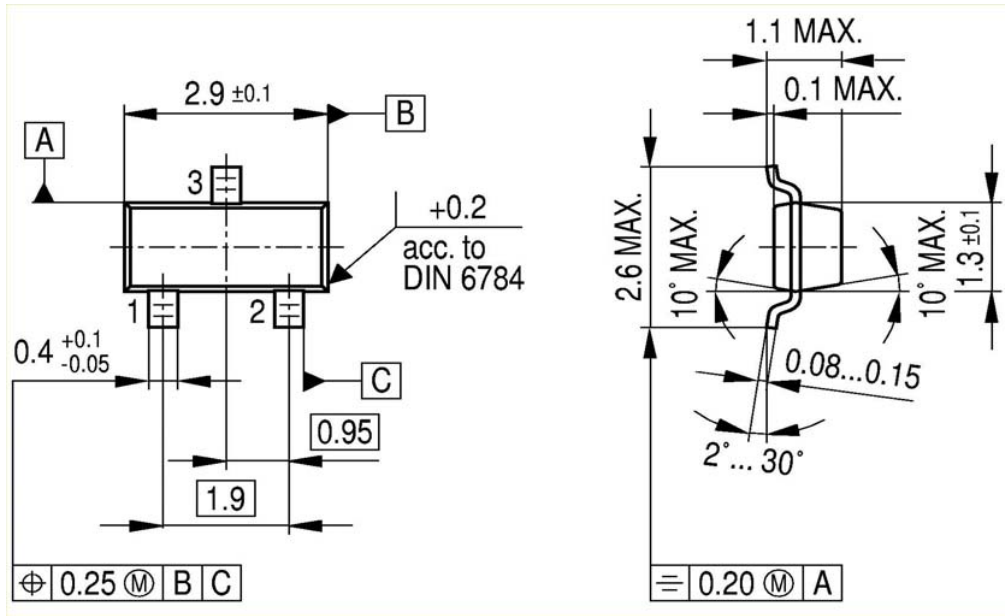

Footprint:

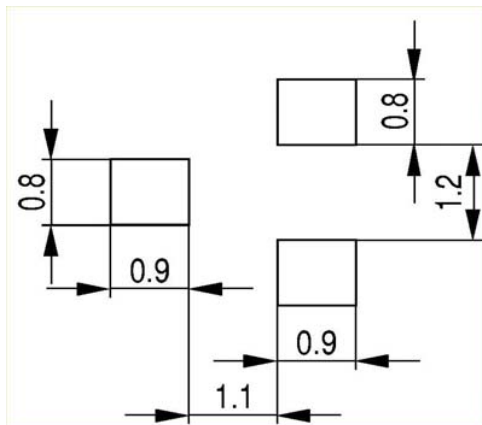

Packaging:

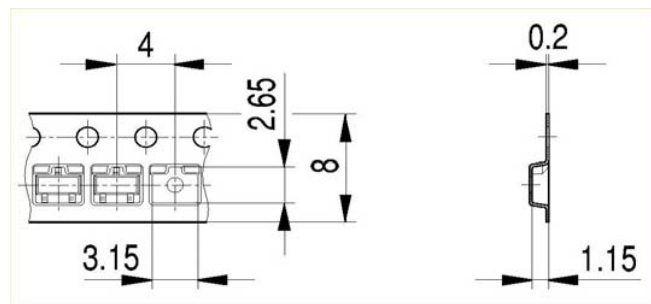

Dimensions in mm

Published by
Infineon Technologies AG
81726 Munich, Germany
© 2009 Infineon Technologies AG
All Rights Reserved.

Legal Disclaimer

The information given in this document shall in no event be regarded as a guarantee of conditions or characteristics. With respect to any examples or hints given herein, any typical values stated herein and/or any information regarding the application of the device, Infineon Technologies hereby disclaims any and all warranties and liabilities of any kind, including without limitation, warranties of non-infringement of intellectual property rights of any third party.

Information

For further information on technology, delivery terms and conditions and prices, please contact the nearest Infineon Technologies Office (www.infineon.com).

Warnings

Due to technical requirements, components may contain dangerous substances. For information on the types in question, please contact the nearest Infineon Technologies Office.

Infineon Technologies components may be used in life-support devices or systems only with the express written approval of Infineon Technologies, if a failure of such components can reasonably be expected to cause the failure of that life-support device or system or to affect the safety or effectiveness of that device or system. Life support devices or systems are intended to be implanted in the human body or to support and/or maintain and sustain and/or protect human life. If they fail, it is reasonable to assume that the health of the user or other persons may be endangered.