

Technical Information

ModSTACK™ 6MS2400R17KE3-3WCH-C21MVTIOIN



Vorläufige Daten
preliminary data

Key data

3x 860A rms at 789V rms, water cooled

General information

Stacks for various inverter application. Semiconductors, heat sinks, capacitors, drivers and sensors included. These are only technical data!

Please read carefully the complete documentation and maintain the proper design environment! Especially note the EMC environment and the controller's functionality.

Topology	DC Link + B6I	
Application / Modulation	Inverter / Sine	
Load type	resistive, inductive	
Cooling	water cooled	
Market	wind	
Implemented sensors	current, voltage, temperature	
Semicond. (Unit 1)	none	
DC Link	10.5mF	
Semicond. (Unit 2)	IGBT	6x FF1200R17KE3
Driver signals IGBT	optical HFBR-15X1 / HFBR-25X1	
Standards	EN50178	
Sales - name	6MS24017E33W32780	
Internal ID	32780	
Mechanical drawing number	32779_MB	
Electrical drawing number	57000008	
Dimensions (width x depth x height)	1090 mm x 596 mm x 329 mm	
Weight	90 kg	

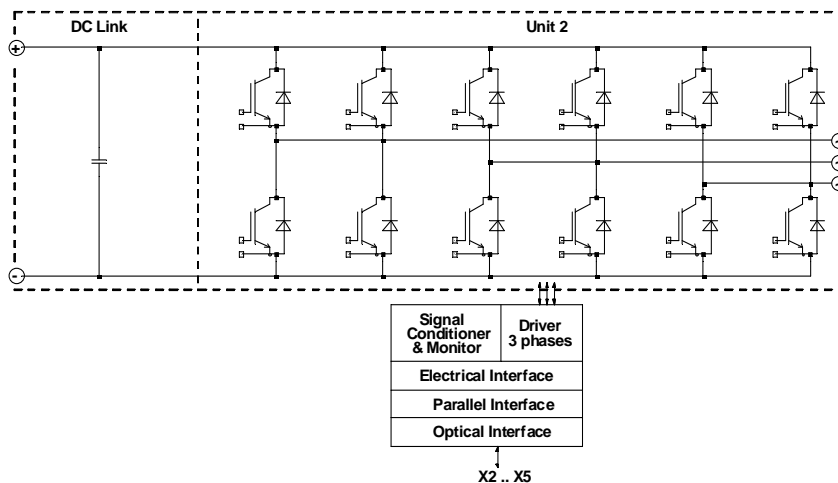
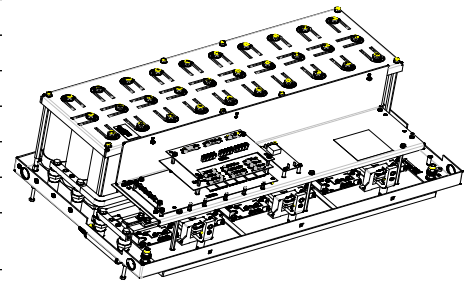

prepared by: Hoelbe Oliver	date of publication: 2009-07-20
approved by: Jürgen Schiele	revision: 2.1

Technical Information

ModSTACK™ 6MS2400R17KE3-3WCH-C21MVTIOIN



Vorläufige Daten preliminary data

Note

Heat sink with copper cooling channel.
Composites of fluid: Water and 52 vol. % Antifrogen N.

Electrical data

DC Link			min	typ	max	units
Voltage		V_{DC}		1150	1250	V
Oversvoltage shutdown	within 150 μ s			1250		V

Unit 2 AC			min	typ	max	units
Voltage	depending on controller	V_{Unit2}		789		V_{RMS}
Continuous current	$V_{Unit2} = 789V_{RMS}$, $V_{DC} = 1150V$, $T_{inlet} = 40^{\circ}C$, $T_J \leq 125^{\circ}C$, $f_{Unit2} = 50Hz$, $f_{sw2} = 3450Hz$, $\cos(\phi) = 0,96$	I_{Unit2}			860	A_{RMS}
Continuous current overload cap.	$T_{inlet} = 40^{\circ}C$, for overload capability 150% for 60s			593		A_{RMS}
Short time current	$T_{inlet} = 40^{\circ}C$, 10s, every 180s, initial load = 739 A_{RMS}	I_{Unit2}			924	A_{RMS}
DC current	no rotating field, $T_{inlet} = 40^{\circ}C$	$I_{Unit2 DC}$			342,0	A_{av}
Overcurrent shutdown	within 15 μ s			1700		A_{peak}
Switching frequency		f_{sw2}			3450	Hz
Power losses	$V_{Unit2} = 789V$, $V_{DC} = 1150V$, $T_{inlet} = 40^{\circ}C$, $T_J \leq 125^{\circ}C$, $f_{Unit2} = 50Hz$, $f_{sw2} = 3450Hz$, $\cos(\phi) = 0,96$, $I_{Unit2} = 860A_{RMS}$	P_{loss2}		15500		W
Power factor		$\cos(\phi)_{Unit2}$	-1,00		1,00	

General data			min	typ	max	units
Power losses (PCB and capacitor)		$P_{loss aux}$			400	W
EMC test	according to IEC61800-3 at named interfaces	power	V_{Burst}	2		kV
		control	V_{Burst}	1		kV
		aux (24V)	V_{Surge}	1		kV
Insulation management is designed for		V_{Line}		690		V_{RMS}
Insulation test voltage	according to EN50178, f = 50Hz, t = 60s	V_{isol}		2,5		kV_{RMS}

Important component data			min	typ	max	units
DC Link capacitor		C_{DC}		10,50		mF
		type	Foil			
Temperature range			-25		+70	$^{\circ}C$
Rated voltage	per device	U_R	1500			V_{DC}
Rated capacitance	per device	C_R	350			μF
Capacitance tolerance	per device	Tol	-10		+10	%
Maximum ripple current	per device, $T_{amb} = 60^{\circ}C$	I_{Rmax}			60	A_{RMS}
wiring system	series, parallel		1s, 30p			
Balance or discharge resistors	per DC Link unit	R_b	6,0			k Ω

prepared by: Hoelbe Oliver	date of publication: 2009-07-20
approved by: Jürgen Schiele	revision: 2.1

Technical Information

ModSTACK™ 6MS2400R17KE3-3WCH-C21MVTIOIN



Vorläufige Daten preliminary data

Controller interface data

			min	typ	max	units
Auxiliary voltage		V_{aux}	18	24	30	V_{av}
Auxiliary power requirement	$V_{aux} = 24V_{av}$	P_{aux}	40			W
Driver and interface board	see separate technical information		TR110 / DR110			
Driver core			EiceDRIVER 2ED300C17-S			
Parallel interface board	see separate technical information		SAD101			
Digital input level	resistor to GND 1,8k Ω , capacitor to GND 4nF, high = on, min 15mA	V_{in}	0,0		15,0	V
Digital output level	open collector, low = ok, max 15mA	V_{out}	0,0		15,0	V
Analog current outputs Unit 2	load max 1mA; at 860A	$V_{ana\ out}$	4,29	4,38	4,47	V
Analog DC Link voltage output	load max 1mA; at 1250V	$V_{DC\ out}$	8,79	8,97	9,15	V
Analog temperature output	load max 1mA; at $T_{NTC} = 62^{\circ}C$ correspond to $T_j = 125^{\circ}C$	$V_{T\ out}$	9,21	9,40	9,59	V
Overtemperature shutdown	at $T_{NTC} = 64^{\circ}C$ correspond to $T_j = 135^{\circ}C$	$V_{T\ out\ OT}$		10		V
Optical interface board	see separate technical information		OEA101			
Optical input power				12		μW
Optical output power					60	μW

Heat sink water cooled / Thermal data

			min	typ	max	units
Water flow	according cooling water specification from infineon	$\Delta V / \Delta t_{Water}$	16			dm ³ /min
Water pressure drop		Δp_{Water}		900		mbar
Water pressure					8	bar
Cooling water inlet temperature		T_{inlet}	-40		40	$^{\circ}C$
Water connection				3/4		in

IGBT data unit 2

			min	typ	max	units
Type	assumed					
collector-emitter saturation voltage	$I_c = 1200A; V_{ge} = 15V; T_{vj} = 125^{\circ}C$	$V_{CE\ sat}$		2,4		V
parameter for linear model	$T_{vj} = 25^{\circ}C$	V_{ce1}		1,1		V
parameter for linear model	$T_{vj} = 25^{\circ}C$	r_{ce1}		0,75		m Ω
parameter for linear model	$T_{vj} = 125^{\circ}C$	V_{ce2}		1		V
parameter for linear model	$T_{vj} = 125^{\circ}C$	r_{ce2}		1,167		m Ω
turn-on / turn-off energy loss per pulse	$T_{vj} = 25^{\circ}C$	E_1		240 / 305		mJ
turn-on / turn-off energy loss per pulse	$T_{vj} = 125^{\circ}C$	E_2		350 / 445		mJ
thermal resistance, junction to case	per IGBT	R_{thjc}		0,021		K/W
thermal resistance, case to heatsink	per IGBT	R_{thch}		0,017		K/W

prepared by: Hoelbe Oliver	date of publication: 2009-07-20
approved by: Jürgen Schiele	revision: 2.1

Technical Information

ModSTACK™ 6MS2400R17KE3-3WCH-C21MVTIOIN



Vorläufige Daten preliminary data

Diode data unit 2

			min	typ	max	units
Type	assumed					
forward voltage	$I_F = 1200A; V_{ge} = 0V; T_{vj} = 125^\circ C$	V_F		1,9		V
parameter for linear model	$T_{vj} = 25^\circ C$	V_{F1}		1,15		V
parameter for linear model	$T_{vj} = 25^\circ C$	r_{F1}		0,542		mΩ
parameter for linear model	$T_{vj} = 125^\circ C$	V_{F2}		1		V
parameter for linear model	$T_{vj} = 125^\circ C$	r_{F2}		0,75		mΩ
reverse recovery energy	$T_{vj} = 25^\circ C$	E_{rec1}		190		mJ
reverse recovery energy	$T_{vj} = 125^\circ C$	E_{rec2}		340		mJ
thermal resistance, junction to case	per Diode	R_{thjc}		0,048		K/W
thermal resistance, case to heatsink	per Diode	R_{thch}		0,039		K/W

Environmental conditions

			min	typ	max	units
Storage temperature		T_{stor}	-40		65	°C
Ambient temperature	minimum 0°C for optional optical interface	T_{amb}	-25		55	°C
Operating temperature	see chapter Heat sink water cooled / Thermal data					
Cooling air velocity (PCB and capacitor)		$V_{Air PCB}$	2,0			m/s
Air pressure	standard atmosphere	p_{Air}	900		1100	hPa
Humidity	no condensation	Rel. F	0		95	%
Installation height			0		1000	m
Vibration	according to EN60068				10	m/s ²
Continuous vibration	according to EN60068				20	m/s ²
Shock	according to EN60068				100	m/s ²
Protection degree			IP00			
Pollution degree			2			
Dimensions	width × depth × height		1090	596	329	mm
Weight with heat sink	approximation			90,0		kg

prepared by: Hoelbe Oliver	date of publication: 2009-07-20
approved by: Jürgen Schiele	revision: 2.1

Vorläufige Daten
preliminary data

fo - derating curve IGBT (motor)
cos(phi) = 0,96
T_{cool medium} = 40°C

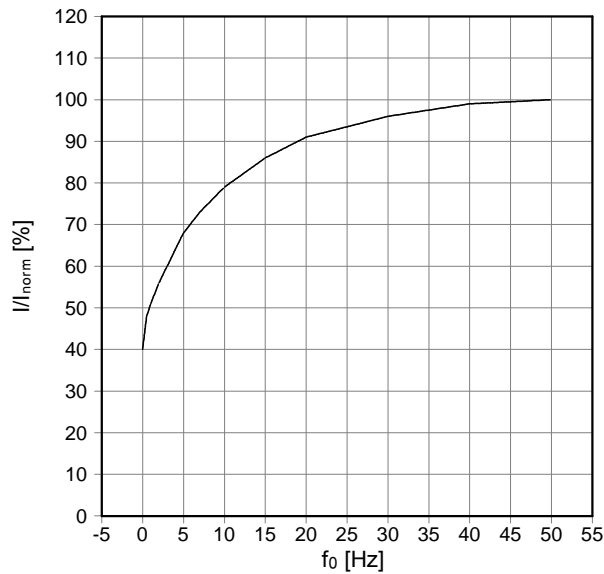

fsw - derating curve IGBT (motor)
cos(phi) = 0,96
T_{cool medium} = 40°C

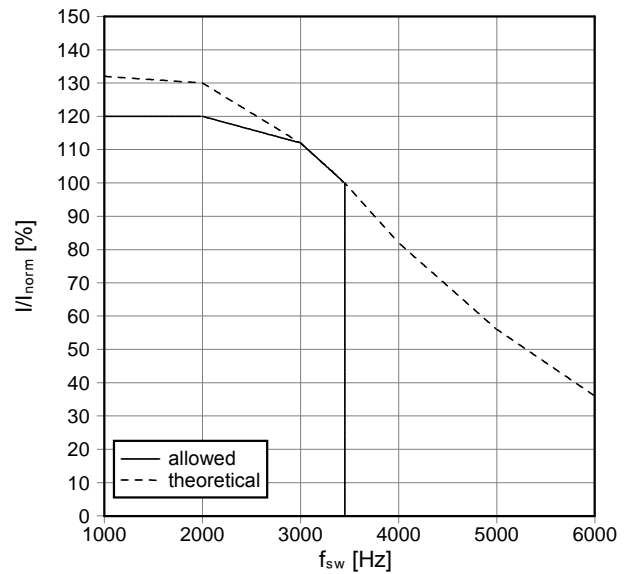

Transient thermal impedance per module
T_{cool medium} = 40°C

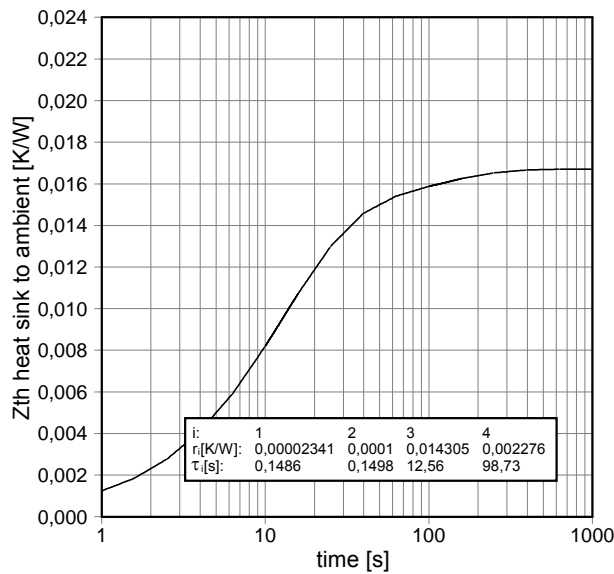

i:	1	2	3	4
r _i [K/W]:	0,00002341	0,0001	0,014305	0,002276
τ _i [s]:	0,1486	0,1498	12,56	98,73

prepared by: Hoelbe Oliver	date of publication: 2009-07-20
approved by: Jürgen Schiele	revision: 2.1

Mechanical drawing

6MS....-3WCH-C21....
ModSTACK
32779 MB

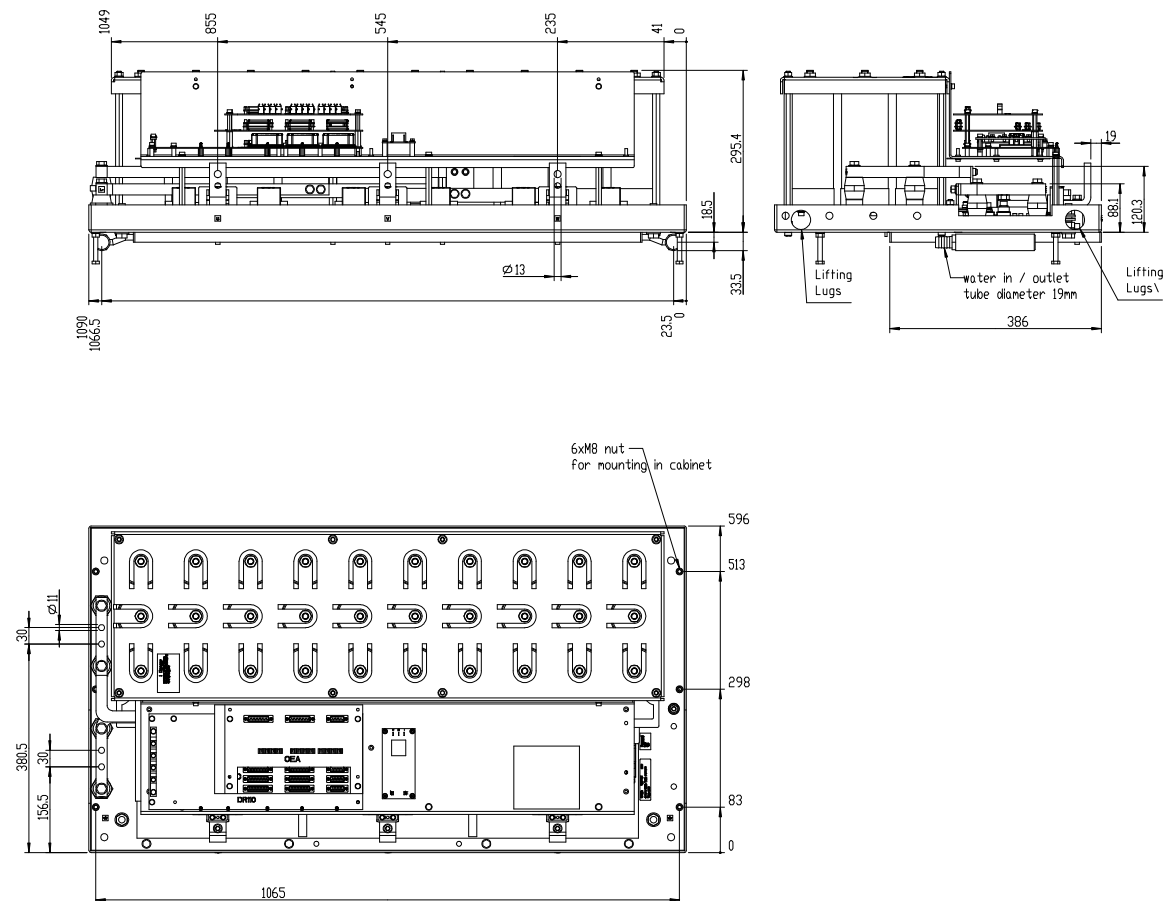

prepared by: Hoelbe Oliver	date of publication: 2009-07-20
approved by: Jürgen Schiele	revision: 2.1

Circuit diagram

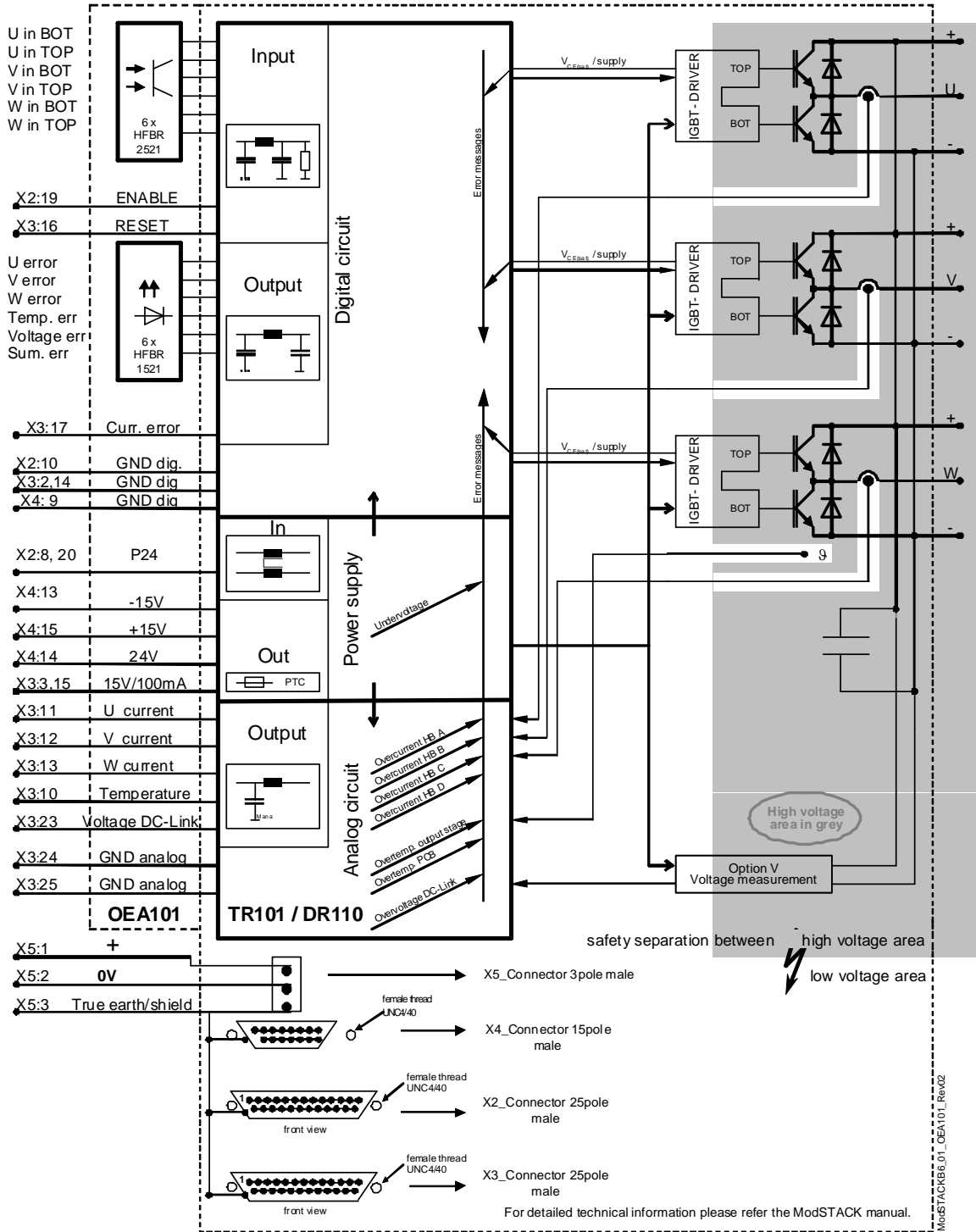

prepared by: Hoelbe Oliver	date of publication: 2009-07-20
approved by: Jürgen Schiele	revision: 2.1

Technical Information

ModSTACK™ 6MS2400R17KE3-3WCH-C21MVTIOIN



Vorläufige Daten
preliminary data

Nutzungsbedingungen

Die in diesem Produktdatenblatt enthaltenen Daten sind ausschließlich für technisch geschultes Fachpersonal bestimmt. Die Beurteilung der Eignung dieses Produktes für Ihre Anwendung sowie die Beurteilung der Vollständigkeit der bereitgestellten Produktdaten für diese Anwendung obliegt Ihnen bzw. Ihren technischen Abteilungen.

In diesem Produktdatenblatt werden diejenigen Merkmale beschrieben, für die wir eine liefervertragliche Gewährleistung übernehmen. Eine solche Gewährleistung richtet sich ausschließlich nach Maßgabe der im jeweiligen Liefervertrag enthaltenen Bestimmungen. Garantien jeglicher Art werden für das Produkt und dessen Eigenschaften keinesfalls übernommen.

Sollten Sie von uns Produktinformationen benötigen, die über den Inhalt dieses Produktdatenblatts hinausgehen und insbesondere eine spezifische Verwendung und den Einsatz dieses Produktes betreffen, setzen Sie sich bitte mit dem für Sie zuständigen Vertriebsbüro in Verbindung (siehe www.infineon.com, Vertrieb&Kontakt). Für Interessenten halten wir Application Notes bereit.

Aufgrund der technischen Anforderungen könnte unser Produkt gesundheitsgefährdende Substanzen enthalten. Bei Rückfragen zu den in diesem Produkt jeweils enthaltenen Substanzen setzen Sie sich bitte ebenfalls mit dem für Sie zuständigen Vertriebsbüro in Verbindung.

Sollten Sie beabsichtigen, das Produkt in Anwendungen der Luftfahrt, in gesundheits- oder lebensgefährdenden oder lebenserhaltenden Anwendungsbereichen einzusetzen, bitten wir um Mitteilung. Wir weisen darauf hin, dass wir für diese Fälle

- die gemeinsame Durchführung eines Risiko- und Qualitätsassessments;
- den Abschluss von speziellen Qualitätssicherungsvereinbarungen;
- die gemeinsame Einführung von Maßnahmen zu einer laufenden Produktbeobachtung dringend empfehlen und gegebenenfalls die Belieferung von der Umsetzung solcher Maßnahmen abhängig machen.

Soweit erforderlich, bitten wir Sie, entsprechende Hinweise an Ihre Kunden zu geben.

Inhaltliche Änderungen dieses Produktdatenblatts bleiben vorbehalten.

Terms & Conditions of usage

The data contained in this product data sheet is exclusively intended for technically trained staff. You and your technical departments will have to evaluate the suitability of the product for the intended application and the completeness of the product data with respect to such application.

This product data sheet is describing the characteristics of this product for which a warranty is granted. Any such warranty is granted exclusively pursuant the terms and conditions of the supply agreement. There will be no guarantee of any kind for the product and its characteristics.

Should you require product information in excess of the data given in this product data sheet or which concerns the specific application of our product, please contact the sales office, which is responsible for you (see www.infineon.com, sales&contact). For those that are specifically interested we may provide application notes.

Due to technical requirements our product may contain dangerous substances. For information on the types in question please contact the sales office, which is responsible for you.

Should you intend to use the Product in aviation applications, in health or live endangering or life support applications, please notify. Please note, that for any such applications we urgently recommend

- to perform joint Risk and Quality Assessments;
- the conclusion of Quality Agreements;
- to establish joint measures of an ongoing product survey, and that we may make delivery depended on the realization of any such measures.

If and to the extent necessary, please forward equivalent notices to your customers.

Changes of this product data sheet are reserved.

prepared by: Hoelbe Oliver	date of publication: 2009-07-20
approved by: Jürgen Schiele	revision: 2.1

Technical Information

ModSTACK™ 6MS2400R17KE3-3WCH-C21MVTIOIN



**Vorläufige Daten
preliminary data**

Sicherheitshinweise

Bevor Sie mit der Installation und dem Betrieb der Baugruppe beginnen, lesen Sie bitte sorgfältig alle Sicherheitshinweise, Warnungen und beachten Sie die angebrachten Warnschilder. Vergewissern Sie sich, dass alle Warnschilder in leserlichem Zustand verbleiben und fehlende oder beschädigte Schilder ersetzt werden.

Safety Instructions

Prior to installation and operation, all safety notices and warnings and all warning signs attached to the equipment have to be carefully read. Make sure that all warning signs remain in a legible condition and that missing or damaged signs are replaced. To installation and operation, all safety notices and warnings and all warning signs attached to the equipment have to be carefully read. Make sure that all warning signs remain in a legible condition and that missing or damaged signs are replaced.

prepared by: Hoelbe Oliver	date of publication: 2009-07-20
approved by: Jürgen Schiele	revision: 2.1