

N

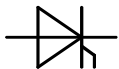

Datenblatt / Data sheet

power electronics in motion

eupec

Netz-Thyristor
Phase Control Thyristor
T571N

 Vorläufige Daten
 Preliminary data

Elektrische Eigenschaften / Electrical properties

Höchstzulässige Werte / Maximum rated values

Periodische Vorwärts- und Rückwärts-Spitzensperrspannung repetitive peak forward off-state and reverse voltages	$T_{vj} = +25^{\circ}\text{C} \dots T_{vj \max}$	$V_{\text{DRM}}, V_{\text{RRM}}$	6500	V
Vorwärts-Stoßspitzensperrspannung non-repetitive peak forward off-state voltage	$T_{vj} = +25^{\circ}\text{C} \dots T_{vj \max}$	V_{DSM}	6600	V
Rückwärts-Stoßspitzensperrspannung non-repetitive peak reverse voltage	$T_{vj} = +25^{\circ}\text{C} \dots T_{vj \max}$	V_{RSM}	6600	V
Durchlaßstrom-Grenzeffektivwert maximum RMS on-state current		I_{TRMSM}	1150	A
Dauergrenzstrom average on-state current	$T_{\text{C}} = 85^{\circ}\text{C}$ $T_{\text{C}} = 60^{\circ}\text{C}$	I_{TAVM}	540 730	A A
Stoßstrom-Grenzwert surge current	$T_{vj} = 25^{\circ}\text{C}, t_{\text{P}} = 10 \text{ ms}$ $T_{vj} = T_{vj \max}, t_{\text{P}} = 10 \text{ ms}$	I_{TSM}	10500 9400	A A
Grenzlastintegral I^2t -value	$T_{vj} = 25^{\circ}\text{C}, t_{\text{P}} = 10 \text{ ms}$ $T_{vj} = T_{vj \max}, t_{\text{P}} = 10 \text{ ms}$	I^2t	551 442	$10^3 \text{ A}^2\text{s}$ $10^3 \text{ A}^2\text{s}$
Kritische Stromsteilheit critical rate of rise of on-state current	DIN IEC 60747-6 $f = 50 \text{ Hz}, I_{\text{GM}} = 3 \text{ A}, di_{\text{C}}/dt = 6 \text{ A}/\mu\text{s}$	$(di_{\text{T}}/dt)_{\text{cr}}$	150	$\text{A}/\mu\text{s}$
Kritische Spannungssteilheit critical rate of rise of off-state voltage	$T_{vj} = T_{vj \max}, V_{\text{D}} = 0,67 V_{\text{DRM}}$ 5.Kennbuchstabe / 5 th letter F	$(dv_{\text{D}}/dt)_{\text{cr}}$	1000	$\text{V}/\mu\text{s}$

Charakteristische Werte / Characteristic values

Durchlaßspannung on-state voltage	$T_{vj} = T_{vj \max}, i_{\text{TM}} = 1 \text{ kA}$	v_{T}	max. 2,75	V
Schleusenspannung threshold voltage	$T_{vj} = T_{vj \max}$	$V_{(\text{TO})}$	1,35	V
Ersatzwiderstand slope resistance	$T_{vj} = T_{vj \max}$	r_{T}	1,4	$\text{m}\Omega$
Durchlaßkennlinie on-state characteristic $v_{\text{T}} = A + B \cdot i_{\text{T}} + C \cdot \ln(i_{\text{T}} + 1) + D \cdot \sqrt{i_{\text{T}}}$	$T_{vj} = T_{vj \max}$	A= B= C= D=	-3,296E-01 1,724E-03 4,376E-01 -5,275E-02	
Zündstrom gate trigger current	$T_{vj} = 25^{\circ}\text{C}, V_{\text{D}} = 12 \text{ V}$	I_{GT}	max. 350	mA
Zündspannung gate trigger voltage	$T_{vj} = 25^{\circ}\text{C}, V_{\text{D}} = 12 \text{ V}$	V_{GT}	max. 2,5	V
Nicht zündender Steuerstrom gate non-trigger current	$T_{vj} = T_{vj \max}, V_{\text{D}} = 12 \text{ V}$ $T_{vj} = T_{vj \max}, V_{\text{D}} = 0,5 V_{\text{DRM}}$	I_{GD}	max. 20 max. 10	mA mA
Nicht zündende Steuerspannung gate non-trigger voltage	$T_{vj} = T_{vj \max}, V_{\text{D}} = 0,5 V_{\text{DRM}}$	V_{GD}	max. 0,4	V
Haltestrom holding current	$T_{vj} = 25^{\circ}\text{C}, V_{\text{D}} = 12 \text{ V}$	I_{H}	max. 350	mA
Einraststrom latching current	$T_{vj} = 25^{\circ}\text{C}, V_{\text{D}} = 12 \text{ V}, R_{\text{GK}} \geq 10 \Omega$ $i_{\text{GM}} = 1 \text{ A}, di_{\text{C}}/dt = 1 \text{ A}/\mu\text{s}, t_{\text{g}} = 20 \mu\text{s}$	I_{L}	max. 3000	mA
Vorwärts- und Rückwärts-Sperrstrom forward off-state and reverse current	$T_{vj} = T_{vj \max}$ $V_{\text{D}} = V_{\text{DRM}}, V_{\text{R}} = V_{\text{RRM}}$	$i_{\text{D}}, i_{\text{R}}$	max. 400	mA
Zündverzögerung gate controlled delay time	DIN IEC 60747-6 $T_{vj} = 25^{\circ}\text{C}, i_{\text{GM}} = 1 \text{ A}, di_{\text{C}}/dt = 1 \text{ A}/\mu\text{s}$	t_{gd}	max. 2,5	μs

Gehäusegrenzstrom nicht spezifiziert / case non rupture current not specified

prepared by:	M.Droidner	date of publication:	27.10.05
approved by:	J.Przybilla	revision:	1

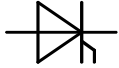
Netz-Thyristor
Phase Control Thyristor
T571N

 Vorläufige Daten
 Preliminary data

Elektrische Eigenschaften / Electrical properties
 Charakteristische Werte / Characteristic values

Freiwerdezeit circuit commutated turn-off time	$T_{vj} = T_{vj\max}, i_{TM} = 1000A$ $V_{RM} = 100 V, V_{DM} = 0,67 V_{DRM}$ $dv_D/dt = 20 V/\mu s, -di_T/dt = 10 A/\mu s$ 4. Kennbuchstabe / 4 th letter O	t_q	typ. 1000	μs
Sperrverzögerungsladung recovered charge	$T_{vj} = T_{vj\max}, i_{TM} = 1000A$ $V_{RM} = 100 V, -di_T/dt = 10 A/\mu s$	Q_r	typ. 3000	μAs
Rückstromspitze peak reverse recovery current	$T_{vj} = T_{vj\max}, i_{TM} = 1000A$ $V_{RM} = 100 V, -di_T/dt = 10 A/\mu s$	I_{RM}	typ. 100	A

Thermische Eigenschaften / Thermal properties

Innerer Wärmewiderstand thermal resistance, junction to case	<u>Kühlfläche / cooling surface</u> beidseitig / two-sided, $\theta = 180^\circ \sin$ beidseitig / two-sided, DC Anode / anode, DC Kathode / cathode, DC	R_{thJC}	max. 0,0230 max. 0,0210 max. 0,0375 max. 0,0480	$^\circ C/W$ $^\circ C/W$ $^\circ C/W$ $^\circ C/W$
Übergangs-Wärmewiderstand thermal resistance, junction to case	<u>Kühlfläche / cooling surface</u> beidseitig / two-sides einseitig / single-sides	R_{thCH}	max. 0,005 max. 0,010	$^\circ C/W$ $^\circ C/W$
Höchstzulässige Sperrschichttemperatur maximum junction temperature		$T_{vj\max}$	125	$^\circ C$
Betriebstemperatur operating temperature		$T_{c\ op}$	-40...+125	$^\circ C$
Lagertemperatur storage temperature		T_{stg}	-40...+150	$^\circ C$

Mechanische Eigenschaften / Mechanical properties

Gehäuse, siehe Anlage case, see annex			Seite 3 page 3	
Si-Element mit Druckkontakt Si-pellet with pressure contact				
Anpresskraft clamping force		F	15...24	kN
Steueranschlüsse control terminals	DIN 46244	Gate Kathode /Cathode	$\varnothing 1,5 \times 3,2$ A 4,8 x 0,8	mm mm
Gewicht weight		G	typ. 550	g
Kriechstrecke creepage distance			25	mm
Schwingfestigkeit vibration resistance	f = 50 Hz		50	m/s ²

Mit diesem Datenblatt werden Halbleiterbauelemente spezifiziert, jedoch keine Eigenschaften zugesichert. Sie gilt in Verbindung mit den zugehörigen technischen Erläuterungen.

This data sheet specifies semiconductor devices, but promises no characteristics. It is valid in combination with the belonging technical notes.

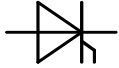
N

Datenblatt / Data sheet

power electronics in motion

eupec
Netz-Thyristor
Phase Control Thyristor

T571N

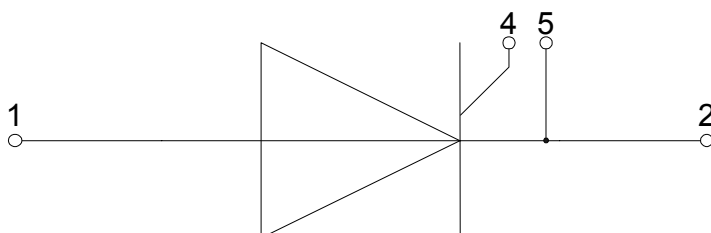
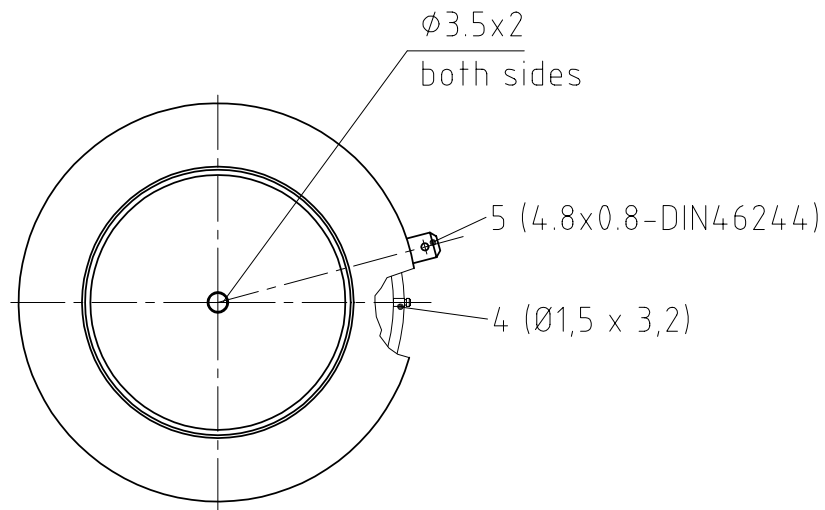
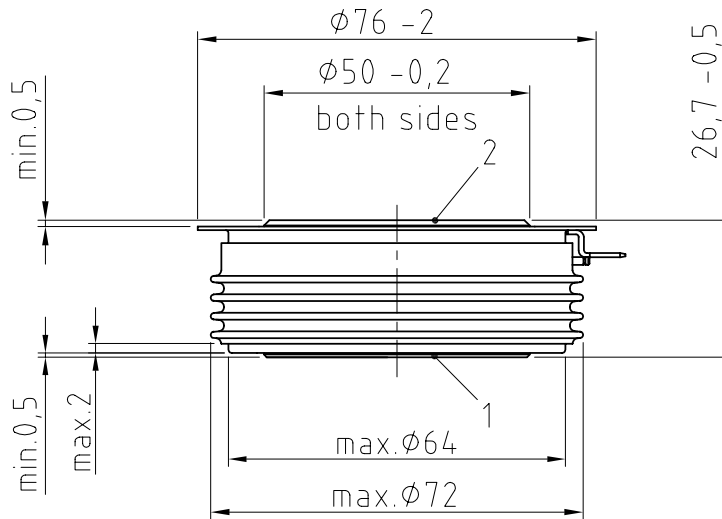
 Vorläufige Daten
 Preliminary data
**1: Anode/Anode****2: Kathode/Cathode****3: Gate****4: Hilfskathode/
Cathode (control terminal)**

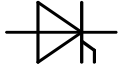

Netz-Thyristor
Phase Control Thyristor

T571N

Vorläufige Daten
Preliminary data

Analytische Elemente des transienten Wärmewiderstandes Z_{thJC} für DC
Analytical elements of transient thermal impedance Z_{thJC} for DC

	Pos. n	1	2	3	4	5	6	7
beidseitig two-sided	R_{thn} [°C/W]	0,00113	0,0021	0,00229	0,00703	0,00845		
	τ_n [s]	0,00189	0,0065	0,00456	0,23	1,134		
anodenseitig anode-sided	R_{thn} [°C/W]	0,00127	0,0026	0,00623	0,0056	0,0218		
	τ_n [s]	0,00201	0,00843	0,126	0,57	6,66		
kathodenseitig cathode-sided	R_{thn} [°C/W]	0,00127	0,0026	0,00623	0,0046	0,0333		
	τ_n [s]	0,00201	0,00843	0,126	0,57	7,83		

Analytische Funktion / Analytical function:

$$Z_{thJC} = \sum_{n=1}^{n_{max}} R_{thn} \left(1 - e^{-\frac{t}{\tau_n}} \right)$$

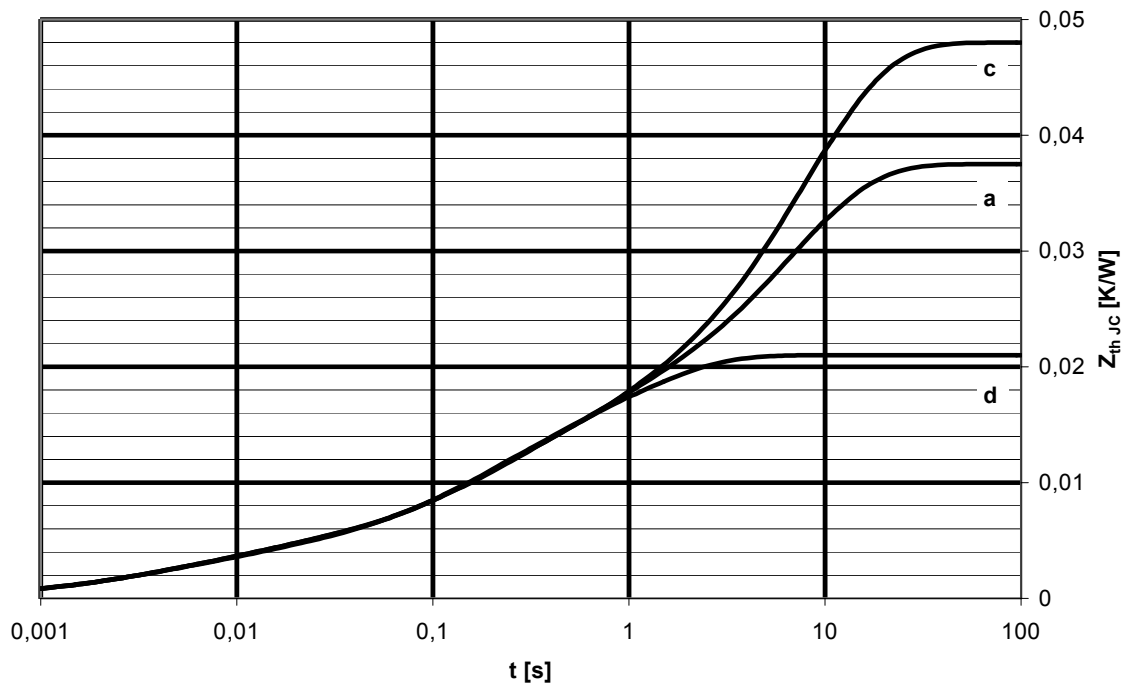

Transienter innerer Wärmewiderstand für DC/ Transient thermal impedance $Z_{thJC} = f(t)$ for DC

d: Beidseitige Kühlung / Two-sided cooling

a: Anodenseitige Kühlung / Anode-sided cooling

c: Kathodenseitige Kühlung / Cathode-sided cooling

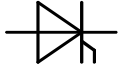

Netz-Thyristor
Phase Control Thyristor

T571N

Vorläufige Daten
Preliminary data

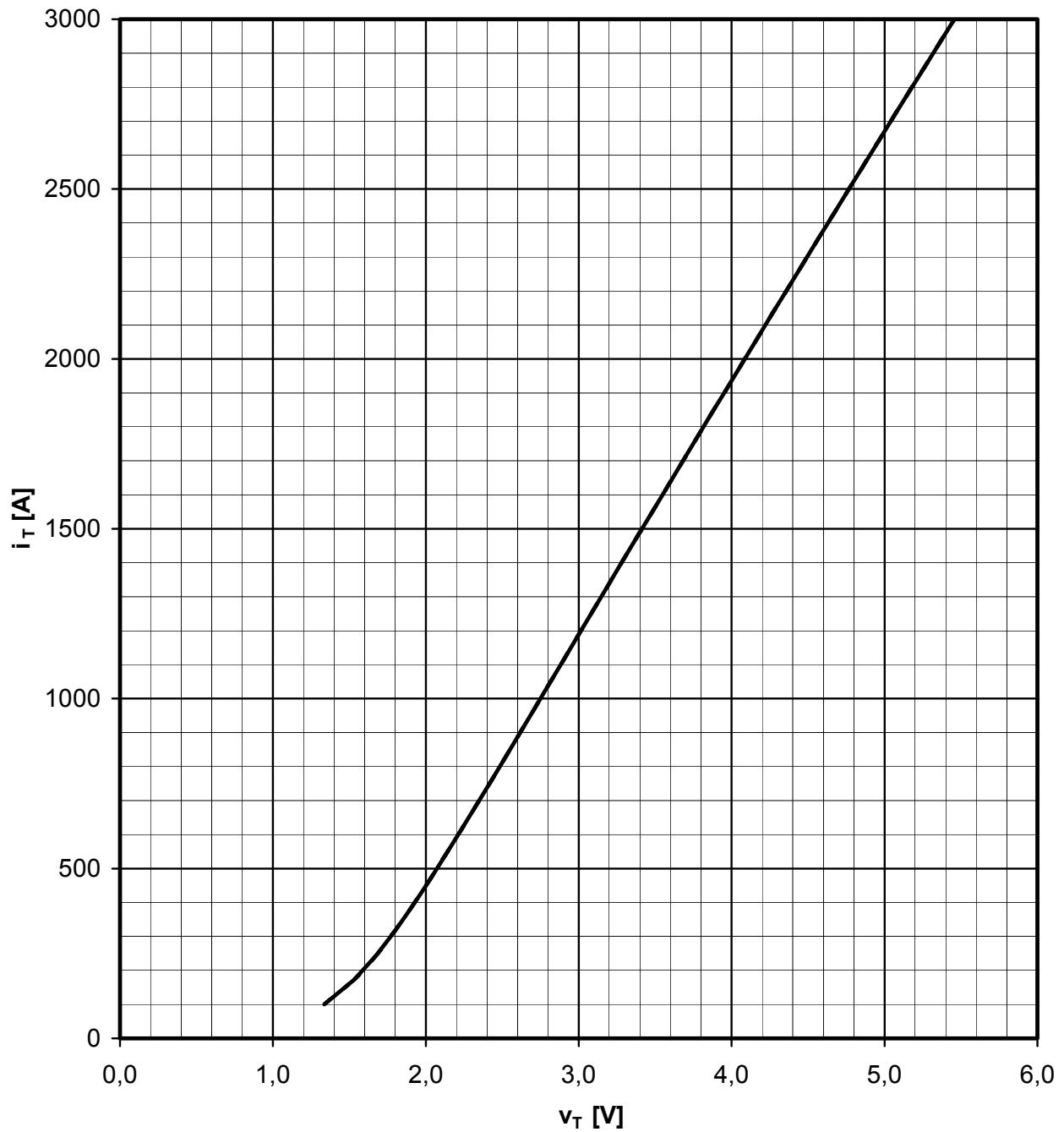

Grenzdurchlaßkennlinie / Limiting on-state characteristic $i_T = f(v_T)$

$$T_{vj} = T_{vj \max}$$

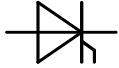

Netz-Thyristor
Phase Control Thyristor

T571N

Vorläufige Daten
Preliminary data

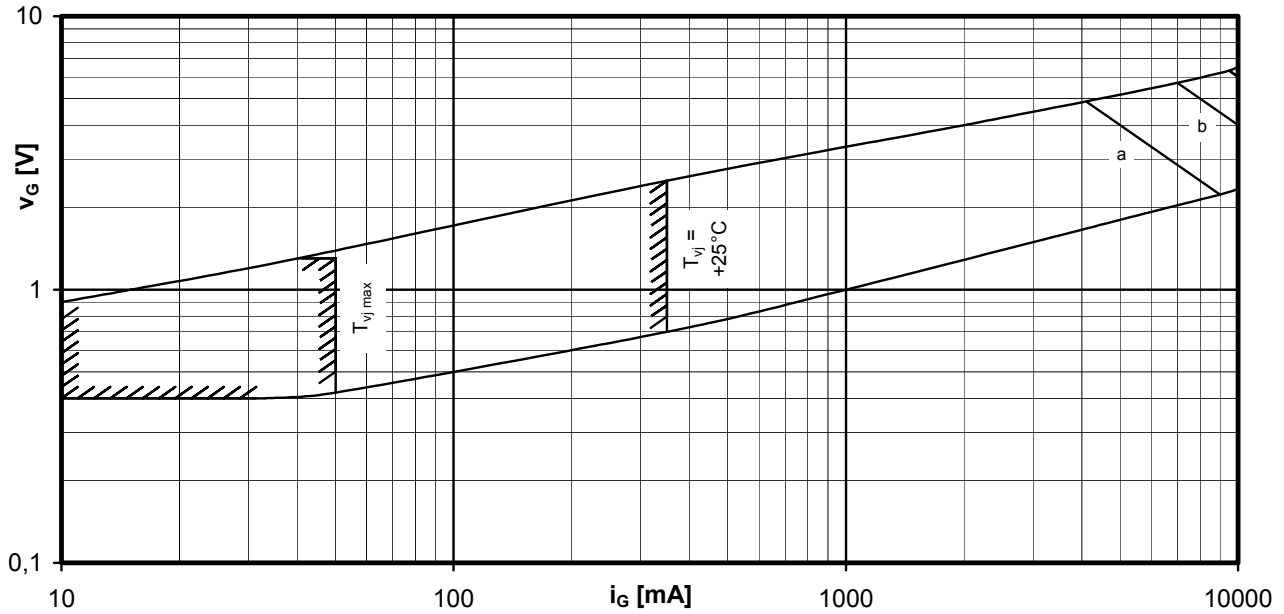

Steuercharakteristik $v_G = f(i_G)$ mit Zündbereichen für $V_D = 12\text{ V}$
Gate characteristic $v_G = f(i_G)$ with triggering area for $V_D = 12\text{ V}$

Höchstzulässige Spitzensteuerverlustleistung / Maximum rated peak gate power dissipation $P_{GM} = f(t_g)$:

a - 20 W/10ms b - 40 W/1ms

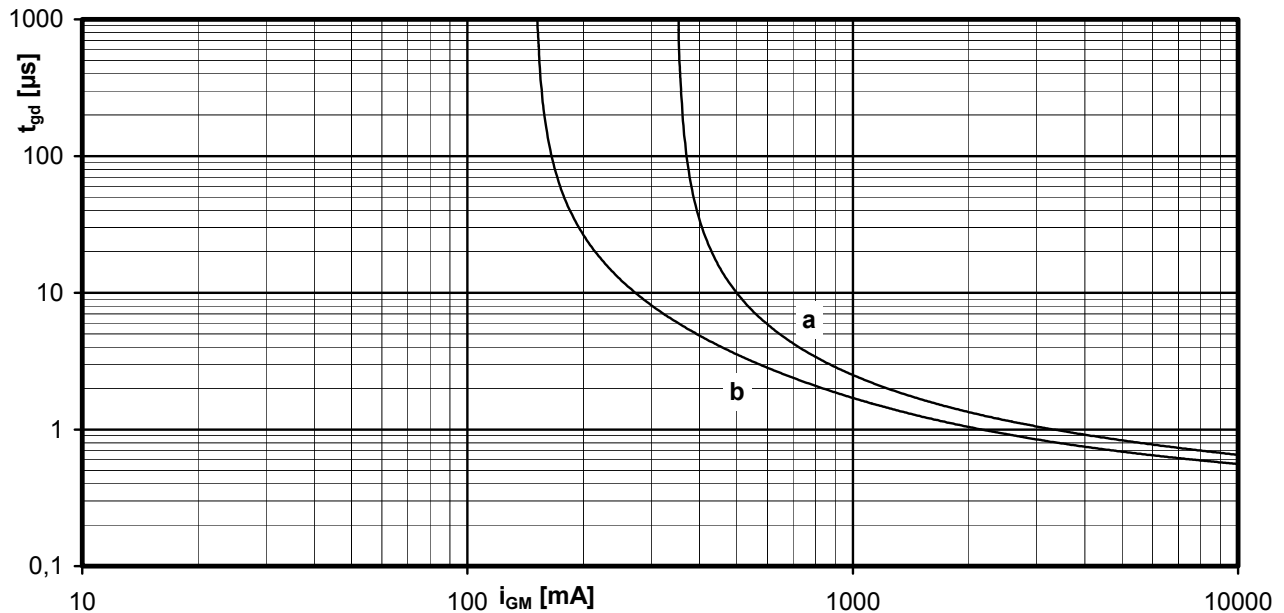

Zündverzug / Gate controlled delay time $t_{gd} = f(i_G)$

$T_{vj} = 25^\circ\text{C}$, $di_G/dt = i_{GM}/1\mu\text{s}$

a - maximaler Verlauf / Limiting characteristic

b - typischer Verlauf / Typical characteristic

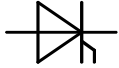

Netz-Thyristor
Phase Control Thyristor

T571N

Vorläufige Daten
Preliminary data

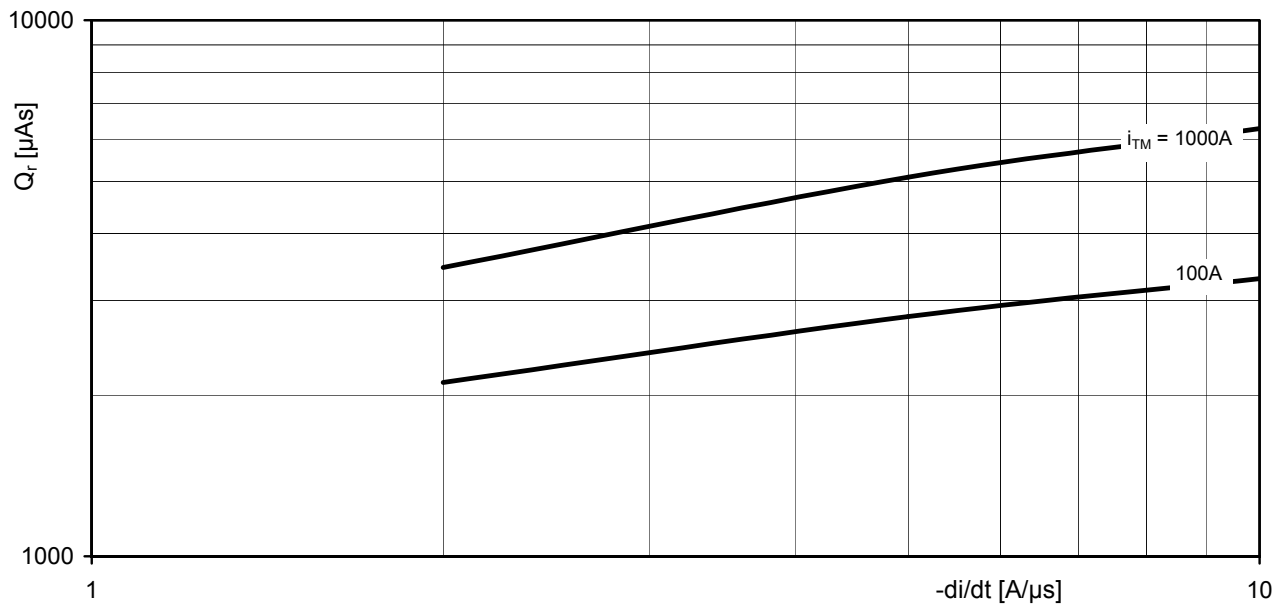

Sperrverzögerungsladung / Recovered charge $Q_r = f(di/dt)$

$$T_{vj} = T_{vjmax}, V_R = 3000V$$

$$R = 83\Omega; C = 0,44\mu F$$

Parameter: Durchlaßstrom / On-state current i_{TM}

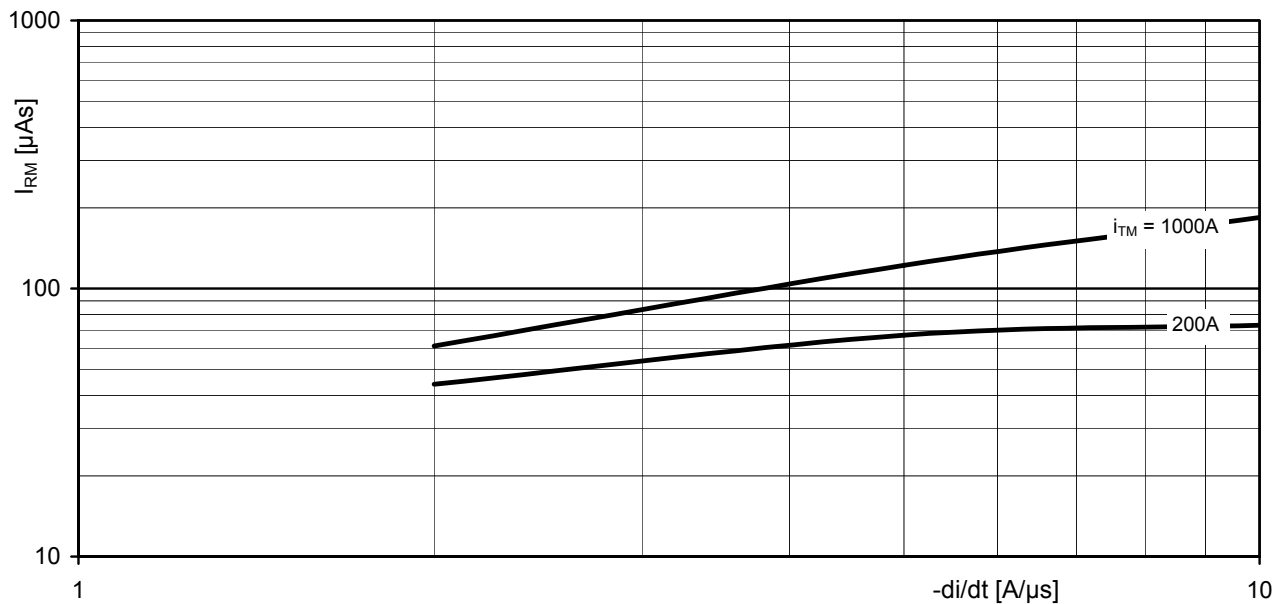

Rückstromspitze / Peak recovery current $I_{RM} = f(di/dt)$

$$T_{vj} = T_{vjmax}, V_R = 3000V$$

$$R = 83\Omega; C = 0,44\mu F$$

Parameter: Durchlaßstrom / On-state current i_{TM}

N		Datenblatt / Data sheet	power electronics in motion eupec
Netz-Thyristor Phase Control Thyristor		T571N	Vorläufige Daten Preliminary data
<p>Nutzungsbedingungen</p> <p>Die in diesem Produktdatenblatt enthaltenen Daten sind ausschließlich für technisch geschultes Fachpersonal bestimmt. Die Beurteilung der Geeignetheit dieses Produktes für die von Ihnen anvisierte Anwendung sowie die Beurteilung der Vollständigkeit der bereitgestellten Produktdaten für diese Anwendung obliegt Ihnen bzw. Ihren technischen Abteilungen.</p> <p>In diesem Produktdatenblatt werden diejenigen Merkmale beschrieben, für die wir eine liefervertragliche Gewährleistung übernehmen. Eine solche Gewährleistung richtet sich ausschließlich nach Maßgabe der im jeweiligen Liefervertrag enthaltenen Bestimmungen. Garantien jeglicher Art werden für das Produkt und dessen Eigenschaften keinesfalls übernommen.</p> <p>Sollten Sie von uns Produktinformationen benötigen, die über den Inhalt dieses Produktdatenblatts hinausgehen und insbesondere eine spezifische Verwendung und den Einsatz dieses Produktes betreffen, setzen Sie sich bitte mit dem für Sie zuständigen Vertriebsbüro in Verbindung (siehe www.eupec.com, Vertrieb&Kontakt). Für Interessenten halten wir Application Notes bereit.</p> <p>Aufgrund der technischen Anforderungen könnte unser Produkt gesundheitsgefährdende Substanzen enthalten. Bei Rückfragen zu den in diesem Produkt jeweils enthaltenen Substanzen setzen Sie sich bitte ebenfalls mit dem für Sie zuständigen Vertriebsbüro in Verbindung.</p> <p>Sollten Sie beabsichtigen, das Produkt in Anwendungen der Luftfahrt, in gesundheits- oder lebensgefährdenden oder lebenserhaltenden Anwendungsbereichen einzusetzen, bitten wir um Mitteilung. Wir weisen darauf hin, dass wir für diese Fälle</p> <ul style="list-style-type: none"> - die gemeinsame Durchführung eines Risiko- und Qualitätsassessments; - den Abschluss von speziellen Qualitätssicherungsvereinbarungen; - die gemeinsame Einführung von Maßnahmen zu einer laufenden Produktbeobachtung dringend empfehlen und gegebenenfalls die Belieferung von der Umsetzung solcher Maßnahmen abhängig machen. <p>Soweit erforderlich, bitten wir Sie, entsprechende Hinweise an Ihre Kunden zu geben.</p> <p>Inhaltliche Änderungen dieses Produktdatenblatts bleiben vorbehalten.</p> <p>Terms & Conditions of usage</p> <p>The data contained in this product data sheet is exclusively intended for technically trained staff. You and your technical departments will have to evaluate the suitability of the product for the intended application and the completeness of the product data with respect to such application.</p> <p>This product data sheet is describing the characteristics of this product for which a warranty is granted. Any such warranty is granted exclusively pursuant the terms and conditions of the supply agreement. There will be no guarantee of any kind for the product and its characteristics.</p> <p>Should you require product information in excess of the data given in this product data sheet or which concerns the specific application of our product, please contact the sales office, which is responsible for you (see www.eupec.com, sales&contact). For those that are specifically interested we may provide application notes.</p> <p>Due to technical requirements our product may contain dangerous substances. For information on the types in question please contact the sales office, which is responsible for you.</p> <p>Should you intend to use the Product in aviation applications, in health or live endangering or life support applications, please notify. Please note, that for any such applications we urgently recommend</p> <ul style="list-style-type: none"> - to perform joint Risk and Quality Assessments; - the conclusion of Quality Agreements; - to establish joint measures of an ongoing product survey, and that we may make delivery depended on the realization of any such measures. <p>If and to the extent necessary, please forward equivalent notices to your customers.</p> <p>Changes of this product data sheet are reserved.</p>			
BIP PPE4 / 27.10.05, M.Droidner			Seite/page 8/8