

N



Datenblatt / Data sheet

 power electronics in motion
eupec
Netz-Thyristor
Phase Control Thyristor
T 3101N
Elektrische Eigenschaften / Electrical properties
 Höchstzulässige Werte / Maximum rated values

Periodische Vorwärts- und Rückwärts-Spitzenperrspannung repetitive peak forward off-state and reverse voltages	$T_{vj} = -40^{\circ}\text{C} \dots T_{vj\text{max}}$	$V_{\text{DRM}}, V_{\text{RRM}}$	4000 4400	4200	V V V
Periodische Vorwärts- und Rückwärts-Spitzenperrspannung repetitive peak forward off-state and reverse voltages	$T_{vj} = 0^{\circ}\text{C} \dots T_{vj\text{max}}$	$V_{\text{DRM}}, V_{\text{RRM}}$	4100 4500	4300	V V V
Durchlaßstrom-Grenzeffektivwert maximum RMS on-state current		I_{TRMSM}		6830	A
Dauergrenzstrom average on-state current	$T_{\text{C}} = 85^{\circ}\text{C}$ $T_{\text{C}} = 60^{\circ}\text{C}$	I_{TAVM}		3160 4350	A A
Stoßstrom-Grenzwert surge current	$T_{vj} = 25^{\circ}\text{C}, t_{\text{P}} = 10 \text{ ms}$ $T_{vj} = T_{vj\text{max}}, t_{\text{P}} = 10 \text{ ms}$	I_{TSM}		87000 83000	A A
Grenzlastintegral I^2t -value	$T_{vj} = 25^{\circ}\text{C}, t_{\text{P}} = 10 \text{ ms}$ $T_{vj} = T_{vj\text{max}}, t_{\text{P}} = 10 \text{ ms}$	I^2t		37800 34000	$10^9 \text{ A}^2\text{s}$ $10^9 \text{ A}^2\text{s}$
Kritische Stromsteilheit critical rate of rise of on-state current	DIN IEC 60747-6 $f = 50 \text{ Hz}, i_{\text{GM}} = 3 \text{ A}, di_{\text{G}}/dt = 6 \text{ A}/\mu\text{s}$	$(di_{\text{T}}/dt)_{\text{cr}}$		300	A/ μs
Kritische Spannungssteilheit critical rate of rise of off-state voltage	$T_{vj} = T_{vj\text{max}}, v_{\text{D}} = 0,67 V_{\text{DRM}}$ 5.Kennbuchstabe / 5 th letter H	$(dv_{\text{D}}/dt)_{\text{cr}}$		2000	V/ μs

Charakteristische Werte / Characteristic values

Durchlaßspannung on-state voltage	$T_{vj} = T_{vj\text{max}}, i_{\text{T}} = 4000 \text{ A}$	v_{T}	typ. 1,6 max. 1,75	V V
Schleusenspannung threshold voltage	$T_{vj} = T_{vj\text{max}}$	$V_{(\text{TO})}$	typ. 0,9 max. 1,01	V V
Ersatzwiderstand slope resistance	$T_{vj} = T_{vj\text{max}}$	r_{T}	typ. 0,175 max. 0,185	m Ω m Ω
Durchlaßkennlinie on-state characteristic $v_{\text{T}} = A + B \cdot i_{\text{T}} + C \cdot \ln(i_{\text{T}} + 1) + D \cdot \sqrt{i_{\text{T}}}$	$T_{vj} = T_{vj\text{max}}$	typ. max.	A -0,1 B 0,000122 C 0,138 D 0,000957 A -0,1 B 0,000108 C 0,139 D 0,00402	
Zündstrom gate trigger current	$T_{vj} = 25^{\circ}\text{C}, v_{\text{D}} = 12 \text{ V}$	i_{GT}	max. 350	mA
Zündspannung gate trigger voltage	$T_{vj} = 25^{\circ}\text{C}, v_{\text{D}} = 12 \text{ V}$	V_{GT}	max. 2,5	V
Nicht zündender Steuerstrom gate non-trigger current	$T_{vj} = T_{vj\text{max}}, v_{\text{D}} = 12 \text{ V}$ $T_{vj} = T_{vj\text{max}}, v_{\text{D}} = 0,5 V_{\text{DRM}}$	i_{GD}	max. 20 max. 10	mA mA
Nicht zündende Steuerspannung gate non-trigger voltage	$T_{vj} = T_{vj\text{max}}, v_{\text{D}} = 0,5 V_{\text{DRM}}$	V_{GD}	max. 0,4	V
Haltestrom holding current	$T_{vj} = 25^{\circ}\text{C}, v_{\text{D}} = 12 \text{ V}$	i_{H}	max. 350	mA
Einraststrom latching current	$T_{vj} = 25^{\circ}\text{C}, v_{\text{D}} = 12 \text{ V}, R_{\text{GK}} \geq 10 \Omega$ $i_{\text{GM}} = 3 \text{ A}, di_{\text{G}}/dt = 6 \text{ A}/\mu\text{s}, t_{\text{g}} = 20 \mu\text{s}$	i_{L}	max. 3	A
Vorwärts- und Rückwärts-Sperrstrom forward off-state and reverse current	$T_{vj} = T_{vj\text{max}}$ $v_{\text{D}} = V_{\text{DRM}}, v_{\text{R}} = V_{\text{RRM}}$	$i_{\text{D}}, i_{\text{R}}$	max. 600	mA
Zündverzögerung gate controlled delay time	DIN IEC 60747-6 $T_{vj} = 25^{\circ}\text{C}, i_{\text{GM}} = 3 \text{ A}, di_{\text{G}}/dt = 6 \text{ A}/\mu\text{s}$	t_{gd}	max. 2	μs

prepared by:	C. Schneider	date of publication:	2005-04-15
approved by:	J. Przybilla	revision:	6

Netz-Thyristor
Phase Control Thyristor
T 3101N
Elektrische Eigenschaften / Electrical properties
 Charakteristische Werte / Characteristic values

Freierdezeit circuit commutated turn-off time	$T_{vj} = T_{vjmax}, i_{TM} = I_{TAVM}$ $V_{RM} = 100 V, v_{bM} = 0,67 V_{DRM}$ $dv_b/dt = 20 V/\mu s, -di_T/dt = 10 A/\mu s$ 4. Kennbuchstabe / 4 th letter O	t_q	typ. 400	μs
Sperrverzögerungsladung recovered charge	$T_{vj} = T_{vjmax}$ $i_{TM} = I_{TAVM}, -di_T/dt = 10 A/\mu s$ $V_R = 0,5V_{RRM}, V_{RM} = 0,8V_{RRM}$	Q_r	max. 15	mAs
Rückstromspitze peak reverse recovery current	$T_{vj} = T_{vjmax}$ $i_{TM} = I_{TAVM}, -di_T/dt = 10 A/\mu s$ $V_R = 0,5V_{RRM}, V_{RM} = 0,8V_{RRM}$	I_{RM}	max. 310	A

Thermische Eigenschaften / Thermal properties

Innerer Wärmewiderstand thermal resistance, junction to case	Kühlfläche / cooling surface beidseitig / two-sided, $\theta = 180^\circ$ sin beidseitig / two-sided, DC Anode / anode, DC Kathode / cathode, DC	$R_{\theta JC}$	max. 0,0054 max. 0,005 max. 0,009 max. 0,0112	$^\circ C/W$ $^\circ C/W$ $^\circ C/W$ $^\circ C/W$
Übergangs-Wärmewiderstand thermal resistance, case to heatsink	Kühlfläche / cooling surface beidseitig / two-sided einseitig / single-sided	$R_{\theta CH}$	max. 0,0015 max. 0,003	$^\circ C/W$ $^\circ C/W$
Höchstzulässige Sperrschichttemperatur maximum junction temperature		T_{vjmax}	125	$^\circ C$
Betriebs temperatur operating temperature		T_{cop}	-40...+125	$^\circ C$
Lagertemperatur storage temperature		T_{stg}	-40...+150	$^\circ C$

Mechanische Eigenschaften / Mechanical properties

Gehäuse, siehe Anlage case, see annex			Seite 3 page 3	
Si-Element mit Druckkontakt Si-pellet with pressure contact				
Anpresskraft clamping force		F	63...91	kN
Steueranschlüsse control terminals	DIN 46244 Gate Kathode /Cathode		A 4,8x0,8 A 6,3x0,8	
Gewicht weight		G	typ. 3000	g
Kriechstrecke creepage distance			49	mm
Schwingfestigkeit vibration resistance	f = 50 Hz		50	m/s ²

N

Datenblatt / Data sheet

power electronics in motion
eupecNetz-Thyristor
Phase Control Thyristor**T 3101N**

T150/35K

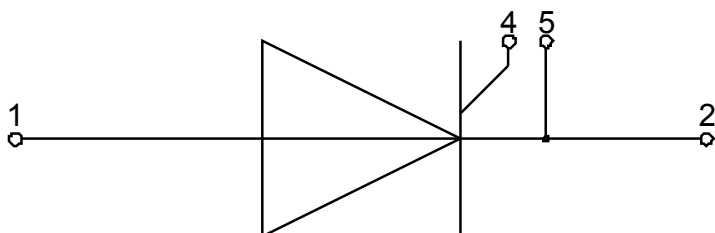
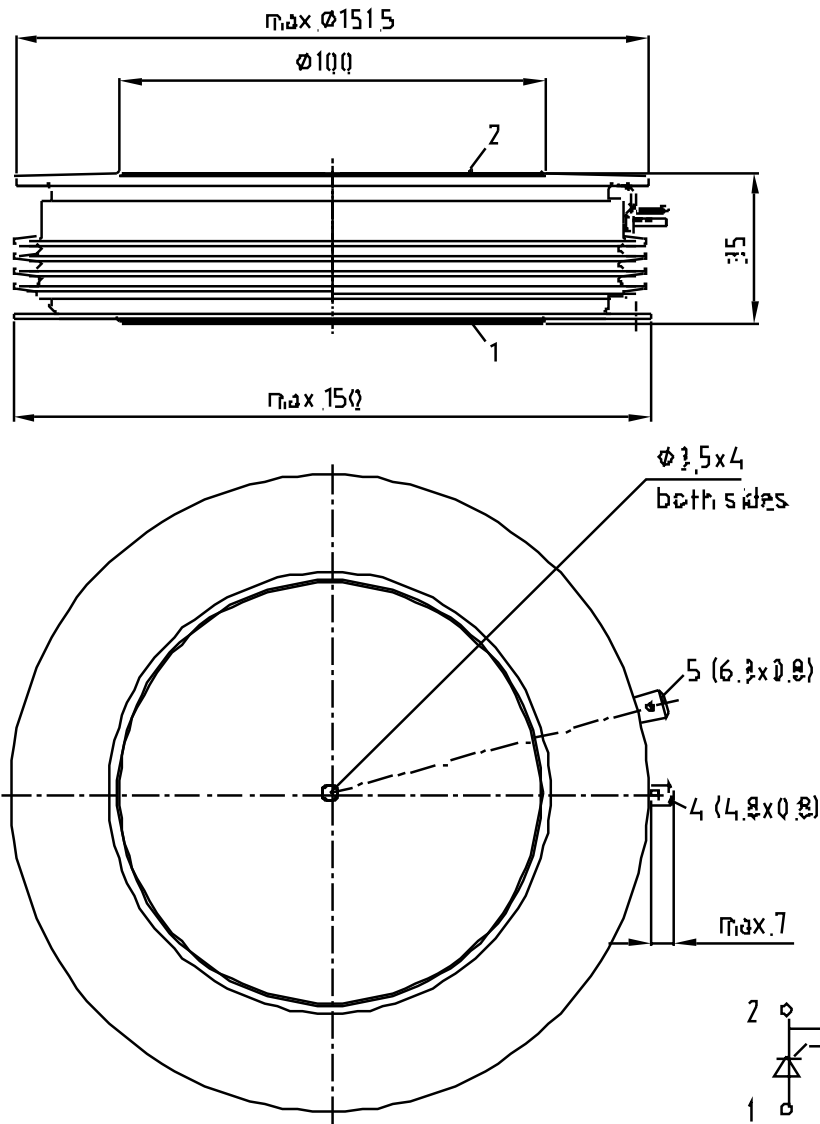
**1:** Anode/Anode**2:** Kathode/Cathode**4:** Gate**5:** Hilfskathode/
Cathode (control terminal)



Netz-Thyristor
Phase Control Thyristor

T 3101N

Analytische Elemente des transienten Wärmewiderstandes Z_{thJC}
Analytical elements of transient thermal impedance Z_{thJC}

	Pos. n	1	2	3	4	5	6	7
beidseitig two-sided	R_{thn} [$^{\circ}C/W$]	0,00158	0,00216	0,00042	0,00055	0,00029		
	τ_n [s]	2,05	0,25	0,09	0,0195	0,0055		
anodenseitig anode-sided	R_{thn} [$^{\circ}C/W$]	0,00558	0,00216	0,00042	0,00055	0,00029		
	τ_n [s]	7,2	0,25	0,09	0,0195	0,0055		
kathodenseitig cathode-sided	R_{thn} [$^{\circ}C/W$]	0,00778	0,00216	0,00042	0,00055	0,00029		
	τ_n [s]	10	0,25	0,09	0,0195	0,0055		

Analytische Funktion / Analytical function:

$$Z_{thJC} = \sum_{n=1}^{n_{max}} R_{thn} \left[1 - e^{-\frac{t}{\tau_n}} \right]$$

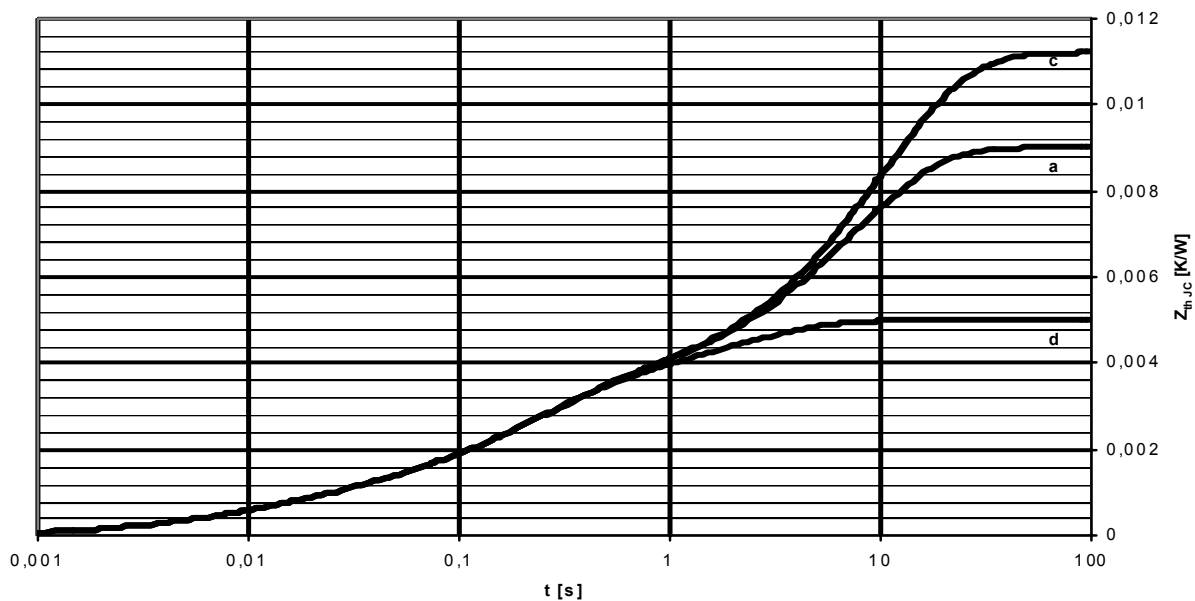

Transienter innerer Wärmewiderstand für DC/ Transient thermal impedance $Z_{thJC} = f(t)$ for DC

Beidseitige Kühlung / Two-sided cooling

Anodenseitige Kühlung / Anode-sided cooling

Kathodenseitige Kühlung / Cathode-sided cooling



Netz-Thyristor
Phase Control Thyristor

T 3101N

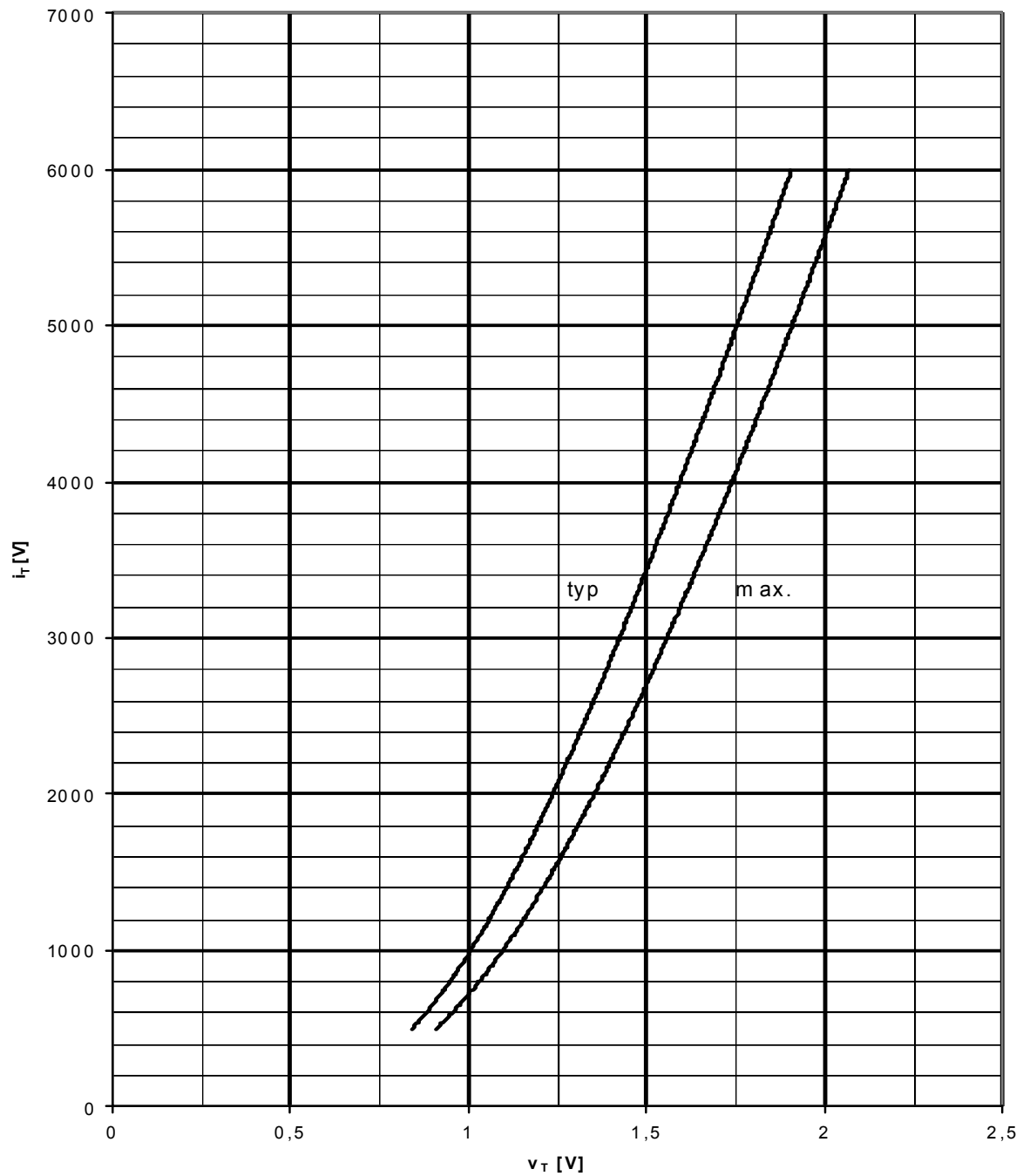

Grenzdurchlaßkennlinie / Limiting on-state characteristic $i_T = f(v_T)$

$$T_{vj} = T_{vj \max}$$



Netz-Thyristor
Phase Control Thyristor

T 3101N

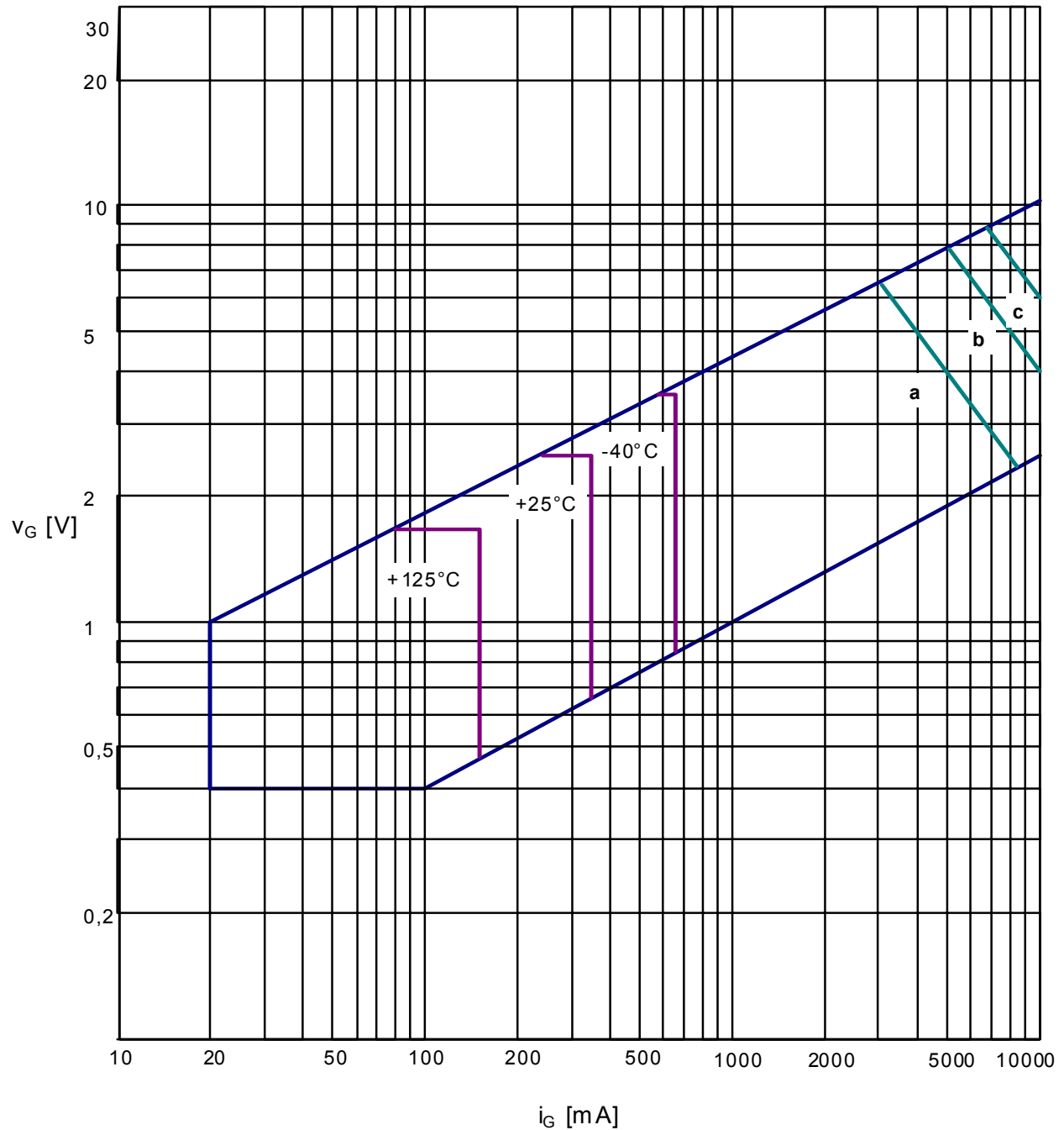

Steuercharakteristik $v_G = f(i_G)$ mit Zündbereichen für $V_D = 6\text{ V}$
Gate characteristic $v_G = f(i_G)$ with triggering area for $V_D = 6\text{ V}$

Höchstzulässige Spitzensteuerverlustleistung / Maximum rated peak gate power dissipation $P_{GM} = f(t_g)$:

a - 20 W/10ms b - 40 W/1ms c - 60 W/0,5ms



Netz-Thyristor
Phase Control Thyristor

T 3101N

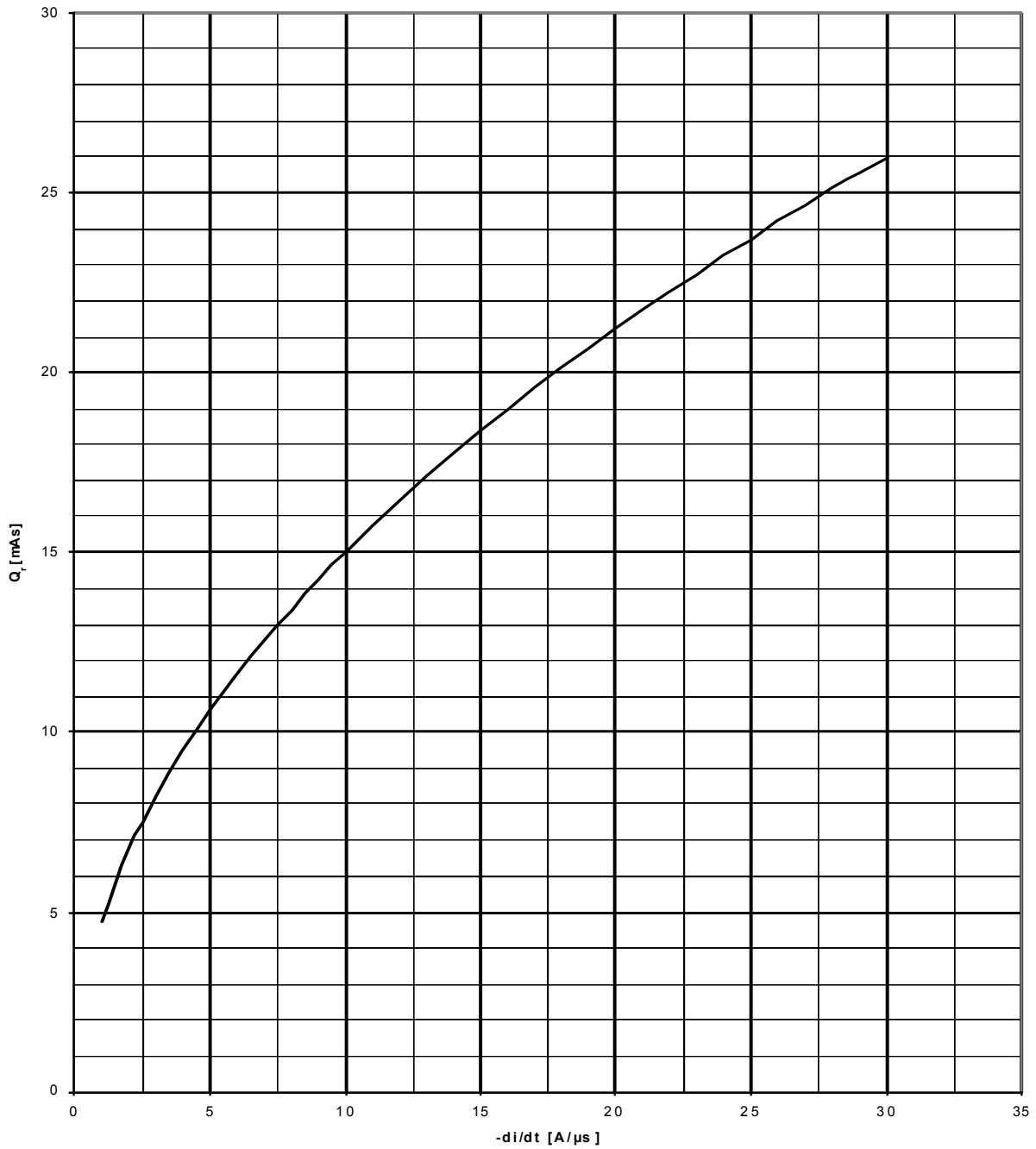

Sperrverzögerungsladung / Recovered charge $Q_r = f(-di/dt)$

$$T_{vj} = T_{vjmax}, V_R = 0,5 V_{RRM}, V_{RM} = 0,8 V_{RRM}$$



Netz-Thyristor
Phase Control Thyristor

T 3101N

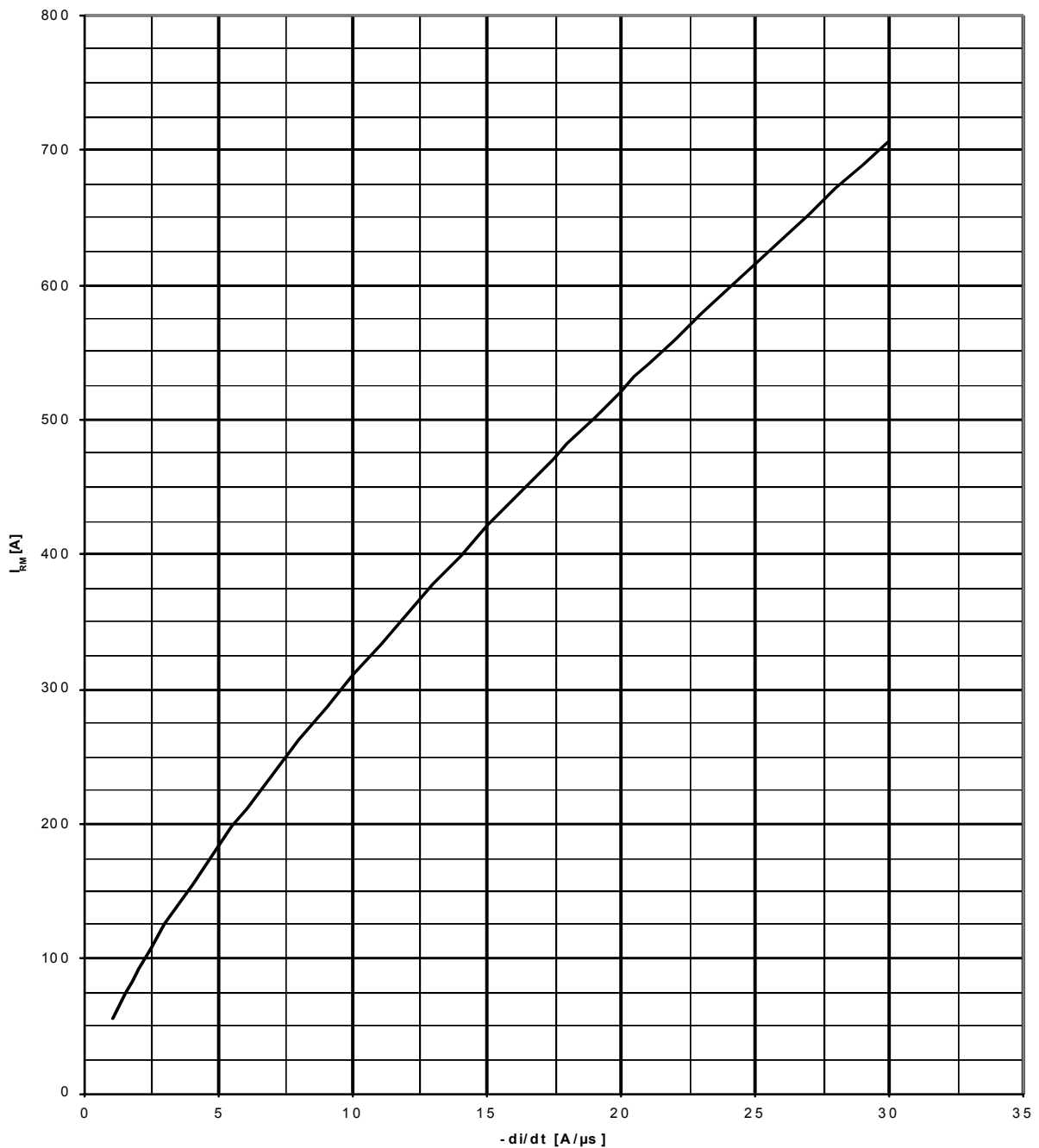

Rückstromspitze / Peak reverse recovery current $I_{RM} = f(-di/dt)$

$$T_{vj} = T_{vjmax}, V_R = 0,5 V_{RRM}, V_{RM} = 0,8 V_{RRM}$$

N		Datenblatt / Data sheet	power electronics in motion eupec
Netz-Thyristor Phase Control Thyristor		T 3101N	
<p>Nutzungsbedingungen</p> <p>Die in diesem Produktdatenblatt enthaltenen Daten sind ausschließlich für technisch geschultes Fachpersonal bestimmt. Die Beurteilung der Eignung dieses Produktes für Ihre Anwendung sowie die Beurteilung der Vollständigkeit der bereitgestellten Produktdaten für diese Anwendung obliegt Ihnen bzw. Ihren technischen Abteilungen.</p> <p>In diesem Produktdatenblatt werden diejenigen Merkmale beschrieben, für die wir eine liefervertragliche Gewährleistung übernehmen. Eine solche Gewährleistung richtet sich ausschließlich nach Maßgabe der im jeweiligen Liefervertrag enthaltenen Bestimmungen. Garantien jeglicher Art werden für das Produkt und dessen Eigenschaften keinesfalls übernommen.</p> <p>Sollten Sie von uns Produktinformationen benötigen, die über den Inhalt dieses Produktdatenblatts hinausgehen und insbesondere eine spezifische Verwendung und den Einsatz dieses Produktes betreffen, setzen Sie sich bitte mit dem für Sie zuständigen Vertriebsbüro in Verbindung. Für Interessenten halten wir Application Notes bereit.</p> <p>Aufgrund der technischen Anforderungen könnte unser Produkt gesundheitsgefährdende Substanzen enthalten. Bei Rückfragen zu den in diesem Produkt jeweils enthaltenen Substanzen setzen Sie sich bitte ebenfalls mit dem für Sie zuständigen Vertriebsbüro in Verbindung.</p> <p>Sollten Sie beabsichtigen, das Produkt in gesundheits- oder lebensgefährdenden oder lebenserhaltenden Anwendungsbereichen einzusetzen, bitten wir um Mitteilung. Wir weisen darauf hin, dass wir für diese Fälle</p> <ul style="list-style-type: none"> - die gemeinsame Durchführung eines Risiko- und Qualitätsassessments; - den Abschluss von speziellen Qualitätssicherungsvereinbarungen; - die gemeinsame Einführung von Maßnahmen einer laufenden Produktbeobachtung dringend empfehlen und gegebenenfalls die Belieferung von der Umsetzung solcher Maßnahmen abhängig machen. <p>Soweit erforderlich, bitten wir Sie, entsprechende Hinweise an Ihre Kunden zu geben.</p> <p>Inhaltliche Änderungen dieses Produktdatenblatts bleiben vorbehalten.</p> <p>Terms & Conditions of usage</p> <p>The product data contained in this product data sheet is exclusively intended for technically trained staff. You and your technical departments will have to evaluate the suitability of the product for the intended application and the completeness of the product data with respect to such application.</p> <p>This product data sheet is describing the specifications of this product for which a warranty is granted. Any such warranty is granted exclusively pursuant the terms and conditions of the supply agreement. There will be no guarantee of any kind for the product and its specifications.</p> <p>Should you require product information in excess of the data given in this product data sheet or which concerns the specific application of our product, please contact the sales office, which is responsible for you. For those that are specifically interested we may provide application notes.</p> <p>Due to technical requirements our product may contain dangerous substances. For information on the types in question please contact the sales office, which is responsible for you.</p> <p>Should you intend to use the Product in health or life endangering or life support applications, please notify. Please note, that for any such applications we urgently recommend</p> <ul style="list-style-type: none"> - to perform joint Risk and Quality Assessments; - the conclusion of Quality Agreements; - to establish joint measures of an ongoing product survey, and that we may make delivery depended on the realization of any such measures. <p>If and to the extent necessary, please forward equivalent notices to your customers.</p> <p>Changes of this product data sheet are reserved.</p>			
BIP AM / SM PB, 2001-04-10, Przybilla J. / Keller			Seite/page 9/9