

N

Datenblatt / Data sheet

Netz-Thyristor
Phase Control Thyristor

T358N

Elektrische Eigenschaften / Electrical properties
 Höchstzulässige Werte / Maximum rated values

Periodische Vorwärts- und Rückwärts-Spitzensperrspannung repetitive peak forward off-state and reverse voltages	$T_{vj} = -40^{\circ}\text{C} \dots T_{vj \text{ max}}$	$V_{\text{DRM}}, V_{\text{RRM}}$	1200 1400	1600 1800	V V
Vorwärts-Stoßspitzensperrspannung non-repetitive peak forward off-state voltage	$T_{vj} = -40^{\circ}\text{C} \dots T_{vj \text{ max}}$	V_{DSM}	1200 1400	1600 1800	V V
Rückwärts-Stoßspitzensperrspannung non-repetitive peak reverse voltage	$T_{vj} = +25^{\circ}\text{C} \dots T_{vj \text{ max}}$	V_{RSM}	1300 1500	1700 1900	V V
Durchlaßstrom-Grenzeffektivwert maximum RMS on-state current		I_{TRMSM}		700	A
Dauergrenzstrom average on-state current	$T_{\text{C}} = 85^{\circ}\text{C}$ $T_{\text{C}} = 69^{\circ}\text{C}$	I_{TAVM}		358 450	A A
Stoßstrom-Grenzwert surge current	$T_{vj} = 25^{\circ}\text{C}, t_p = 10 \text{ ms}$ $T_{vj} = T_{vj \text{ max}}, t_p = 10 \text{ ms}$	I_{TSM}		5200 4600	A A
Grenzlastintegral I^2t -value	$T_{vj} = 25^{\circ}\text{C}, t_p = 10 \text{ ms}$ $T_{vj} = T_{vj \text{ max}}, t_p = 10 \text{ ms}$	I^2t		135 106	$10^3 \text{ A}^2\text{s}$ $10^3 \text{ A}^2\text{s}$
Kritische Stromsteilheit critical rate of rise of on-state current	DIN IEC 60747-6 $f = 50 \text{ Hz}, i_{\text{GM}} = 1 \text{ A}, di_{\text{G}}/dt = 1 \text{ A}/\mu\text{s}$	$(di_{\text{T}}/dt)_{\text{cr}}$		150	A/ μs
Kritische Spannungssteilheit critical rate of rise of off-state voltage	$T_{vj} = T_{vj \text{ max}}, V_{\text{D}} = 0,67 V_{\text{DRM}}$ 5.Kennbuchstabe / 5 th letter F	$(dv_{\text{D}}/dt)_{\text{cr}}$		1000	V/ μs

Charakteristische Werte / Characteristic values

Durchlaßspannung on-state voltage	$T_{vj} = T_{vj \text{ max}}, i_{\text{T}} = 1200 \text{ A}$ $T_{vj} = T_{vj \text{ max}}, i_{\text{T}} = 200 \text{ A}$	v_{T}	max. max.	2,07 1,10	V V
Schleusenspannung threshold voltage	$T_{vj} = T_{vj \text{ max}}$	$V_{(\text{TO})}$		0,85	V
Ersatzwiderstand slope resistance	$T_{vj} = T_{vj \text{ max}}$	r_{T}		0,9	m Ω
Durchlaßkennlinie 100 A $\leq i_{\text{T}} \leq 1700 \text{ A}$ on-state characteristic $v_{\text{T}} = A + B \cdot i_{\text{T}} + C \cdot \ln(i_{\text{T}} + 1) + D \cdot \sqrt{i_{\text{T}}}$	$T_{vj} = T_{vj \text{ max}}$	A= B= C= D=		1,042E+00 4,125E-04 -1,077E-01 3,721E-02	
Zündstrom gate trigger current	$T_{vj} = 25^{\circ}\text{C}, V_{\text{D}} = 12\text{V}$	I_{GT}	max.	200	mA
Zündspannung gate trigger voltage	$T_{vj} = 25^{\circ}\text{C}, V_{\text{D}} = 12\text{V}$	V_{GT}	max.	2	V
Nicht zündender Steuerstrom gate non-trigger current	$T_{vj} = T_{vj \text{ max}}, V_{\text{D}} = 12\text{V}$ $T_{vj} = T_{vj \text{ max}}, V_{\text{D}} = 0,5 V_{\text{DRM}}$	I_{GD}	max. max.	10 5	mA mA
Nicht zündende Steuerspannung gate non-trigger voltage	$T_{vj} = T_{vj \text{ max}}, V_{\text{D}} = 0,5 V_{\text{DRM}}$	V_{GD}	max.	0,2	V
Haltestrom holding current	$T_{vj} = 25^{\circ}\text{C}, V_{\text{D}} = 12\text{V}$	I_{H}	max.	300	mA
Einraststrom latching current	$T_{vj} = 25^{\circ}\text{C}, V_{\text{D}} = 12\text{V}, R_{\text{GK}} \geq 10 \Omega$ $i_{\text{GM}} = 1 \text{ A}, di_{\text{G}}/dt = 1 \text{ A}/\mu\text{s}, t_{\text{g}} = 20 \mu\text{s}$	I_{L}	max.	1200	mA
Vorwärts- und Rückwärts-Sperrstrom forward off-state and reverse current	$T_{vj} = T_{vj \text{ max}}$ $V_{\text{D}} = V_{\text{DRM}}, V_{\text{R}} = V_{\text{RRM}}$	$i_{\text{D}}, i_{\text{R}}$	max.	50	mA
Zündverzögerung gate controlled delay time	DIN IEC 60747-6 $T_{vj} = 25^{\circ}\text{C}, i_{\text{GM}} = 1 \text{ A}$ $di_{\text{G}}/dt = 1 \text{ A}/\mu\text{s}$	t_{gd}	max.	3	μs

prepared by:	H.Sandmann	date of publication:	2007-09-03
approved by:	J.Przybilla	revision:	1

Netz-Thyristor
Phase Control Thyristor
T358N
Elektrische Eigenschaften / Electrical properties
 Charakteristische Werte / Characteristic values

Freierdezeit circuit commutated turn-off time	$T_{vj} = T_{vj\max}, i_{TM} = I_{TAVM}$ $V_{RM} = 100\text{ V}, V_{DM} = 0,67 V_{DRM}$ $dv_D/dt = 20\text{ V}/\mu\text{s}, -di_T/dt = 10\text{ A}/\mu\text{s}$ 4.Kennbuchstabe / 4 th letter O	t_q	typ.	250	μs
--	---	-------	------	-----	---------------

Thermische Eigenschaften / Thermal properties

Innerer Wärmewiderstand thermal resistance, junction to case	<u>Kühlfläche / cooling surface</u> beidseitig / two-sided, $\theta = 180^\circ\text{sin}$ beidseitig / two-sided, DC Anode / anode, $\theta = 180^\circ\text{sin}$ Anode / anode, DC Kathode / cathode, $\theta = 180^\circ\text{sin}$ Kathode / cathode, DC	R_{thJC}	max.	0,068	$^\circ\text{C}/\text{W}$
			max.	0,065	$^\circ\text{C}/\text{W}$
			max.	0,113	$^\circ\text{C}/\text{W}$
			max.	0,110	$^\circ\text{C}/\text{W}$
			max.	0,159	$^\circ\text{C}/\text{W}$
			max.	0,156	$^\circ\text{C}/\text{W}$
Übergangs-Wärmewiderstand thermal resistance, case to heatsink	<u>Kühlfläche / cooling surface</u> beidseitig / two-sides einseitig / single-sides	R_{thCH}	max.	0,015	$^\circ\text{C}/\text{W}$
			max.	0,030	$^\circ\text{C}/\text{W}$
Höchstzulässige Sperrschichttemperatur maximum junction temperature		$T_{vj\max}$		125	$^\circ\text{C}$
Betriebstemperatur operating temperature		$T_{c\text{op}}$		-40...+125	$^\circ\text{C}$
Lagertemperatur storage temperature		T_{stg}		-40...+140	$^\circ\text{C}$

Mechanische Eigenschaften / Mechanical properties

Gehäuse, siehe Anlage case, see annex				Seite 3 page 3	
Si-Element mit Druckkontakt Si-pellet with pressure contact					
Anpresskraft clamping force		F		4...8	kN
Steueranschlüsse control terminals	Gate Kathode / cathode			A 2,8x0,8 A 2,8x0,8	
Gewicht weight		G	typ.	70	g
Kriechstrecke creepage distance				17	mm
Schwingfestigkeit vibration resistance	$f = 50\text{ Hz}$			50	m/s^2

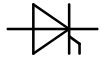

Netz-Thyristor
Phase Control Thyristor

T358N

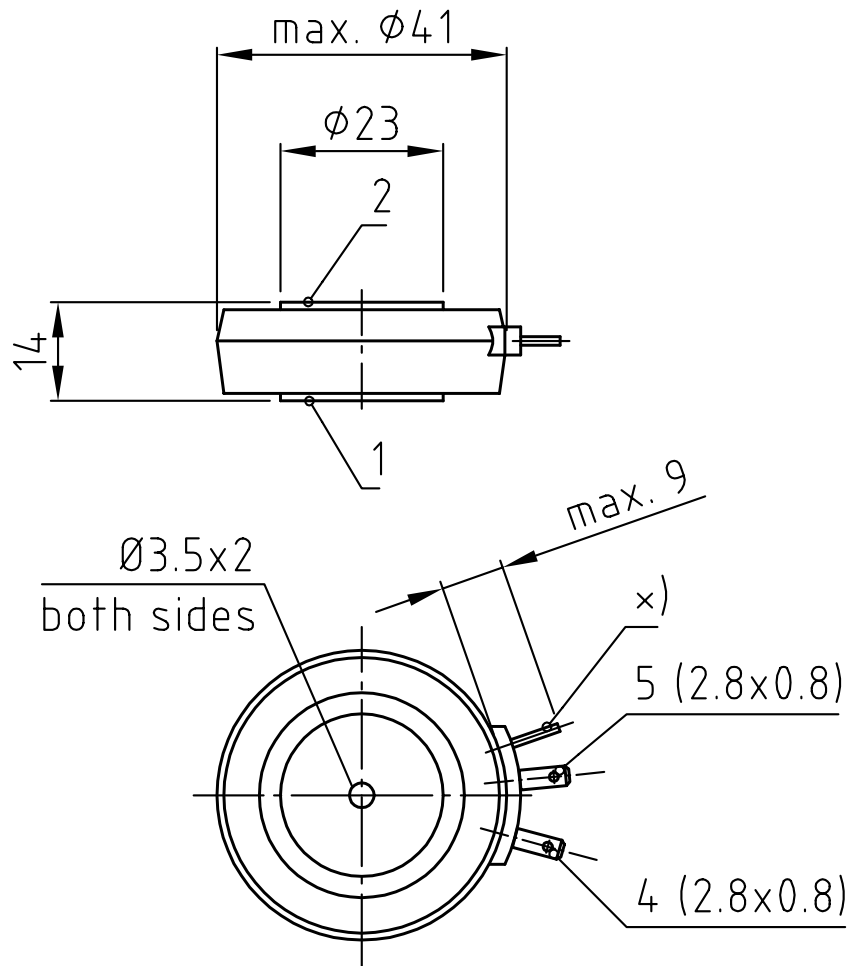

x) Pumpröhrchen (isoliert betreiben!), evacuation pipe (keep insulated!)

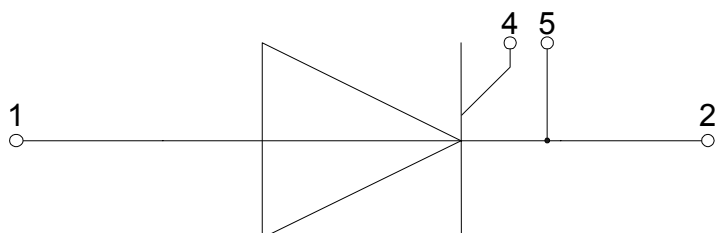

1: Anode / Anode
2: Kathode / Cathode
4: Gate
5: Hilfskathode/
Auxiliary Cathode

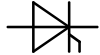

Netz-Thyristor
Phase Control Thyristor

T358N

Analytische Elemente des transienten Wärmewiderstandes Z_{thJC} für DC
Analytical elements of transient thermal impedance Z_{thJC} for DC

Kühlung / Cooling	Pos. n	1	2	3	4	5	6	7
beidseitig two-sided	R_{thn} [°C/W]	0,00832	0,01510	0,0181	0,02062	0,00286	-	-
	τ_n [s]	0,00083	0,01660	0,0808	0,35900	1,95700	-	-
anodenseitig anode-sided	R_{thn} [°C/W]	0,00957	0,00543	0,0209	0,01420	0,02710	0,0328	-
	τ_n [s]	0,00104	0,01330	0,0364	0,23000	1,52000	10,500	-
kathodenseitig cathode-sided	R_{thn} [°C/W]	0,00980	0,01860	0,0157	0,06170	0,05020	-	-
	τ_n [s]	0,00106	0,02270	0,0994	2,04000	10,2000	-	-

Analytische Funktion / Analytical function:

$$Z_{thJC} = \sum_{n=1}^{n_{max}} R_{thn} \left(1 - e^{-\frac{t}{\tau_n}} \right)$$

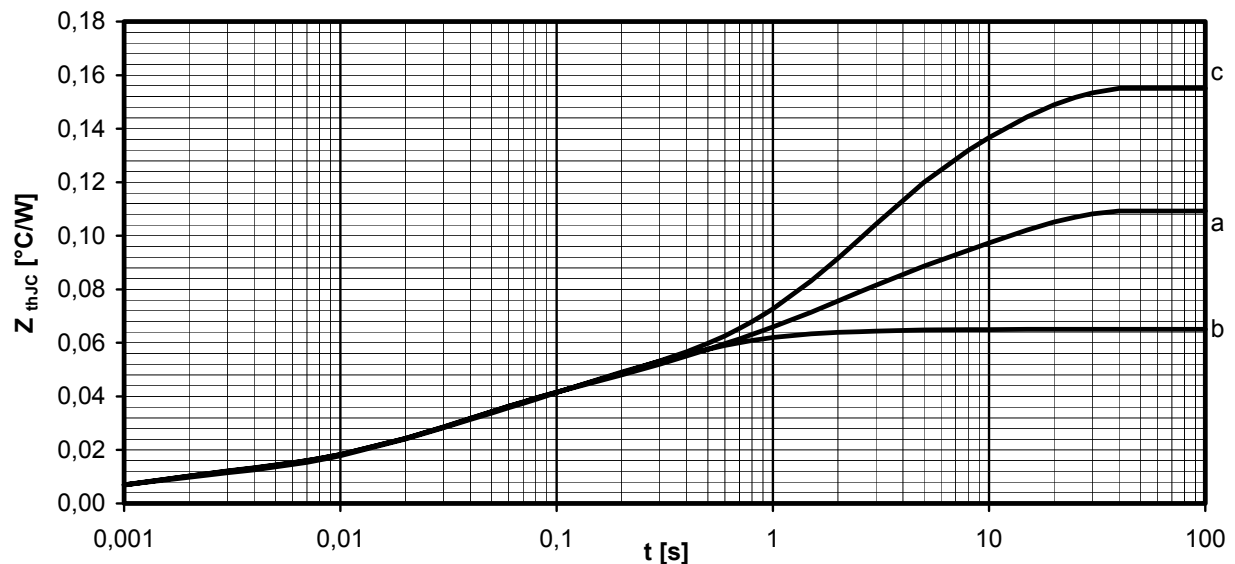

Transienter innerer Wärmewiderstand für DC / Transient thermal impedance for DC
 $Z_{thJC} = f(t)$

- a - Anodenseitige Kühlung / Anode-sided cooling
- b - Beidseitige Kühlung / Two-sided cooling
- c - Kathodenseitige Kühlung / Cathode-sided cooling

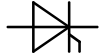

Netz-Thyristor
Phase Control Thyristor

T358N

Erhöhung des $Z_{th DC}$ bei Sinus und Rechteckströmen mit unterschiedlichen Stromflusswinkeln Θ
 Rise of $Z_{th DC}$ for sinewave and rectangular current with different current conduction angles Θ

$\Delta Z_{th \Theta rec} / \Delta Z_{th \Theta sin}$

Kühlung / Cooling		$\Theta = 180^\circ$	$\Theta = 120^\circ$	$\Theta = 90^\circ$	$\Theta = 60^\circ$	$\Theta = 30^\circ$
beidseitig two-sided	$\Delta Z_{th \Theta rec}$ [°C/W]	0,01415	0,02485	0,03437	0,05161	0,09055
	$\Delta Z_{th \Theta sin}$ [°C/W]	0,00373	0,00716	0,01262	0,02518	0,06274
anodenseitig anode-sided	$\Delta Z_{th \Theta rec}$ [°C/W]	0,01479	0,02639	0,03682	0,05518	0,09302
	$\Delta Z_{th \Theta sin}$ [°C/W]	0,00442	0,00848	0,01517	0,03000	0,06893
kathodenseitig cathode-sided	$\Delta Z_{th \Theta rec}$ [°C/W]	0,01480	0,02647	0,03703	0,05558	0,09361
	$\Delta Z_{th \Theta sin}$ [°C/W]	0,00435	0,00844	0,01524	0,03030	0,06959

$$Z_{th \Theta rec} = Z_{th DC} + \Delta Z_{th \Theta rec}$$

$$Z_{th \Theta sin} = Z_{th DC} + \Delta Z_{th \Theta sin}$$

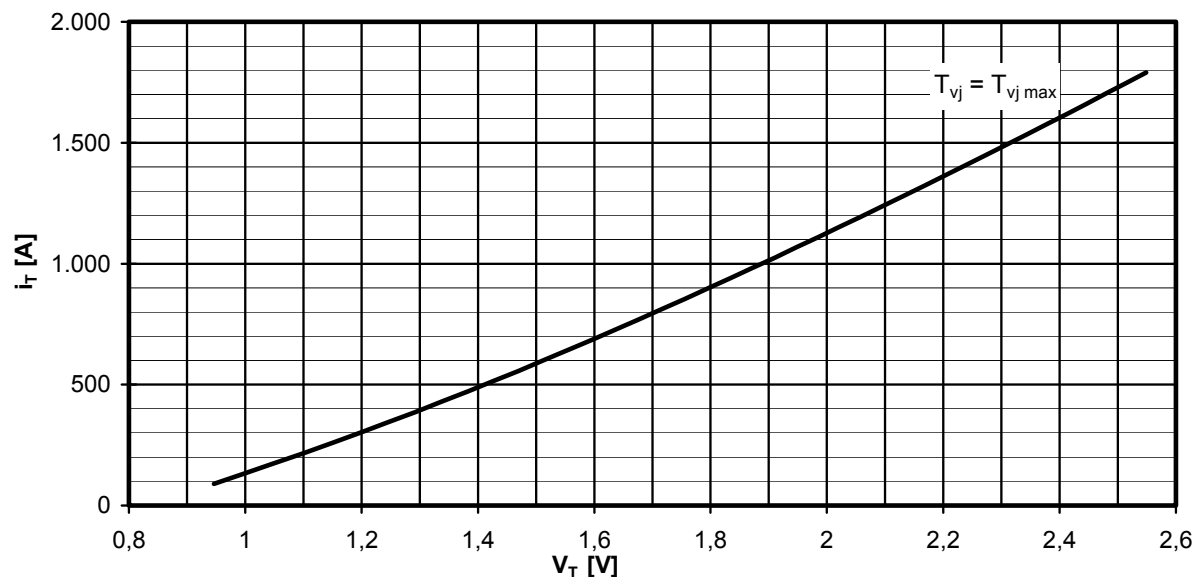

Grenzdurchlaßkennlinie / Limiting on-state characteristic $i_T = f(v_T)$

$T_{vj} = T_{vj max}$

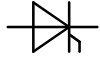

Netz-Thyristor
Phase Control Thyristor

T358N

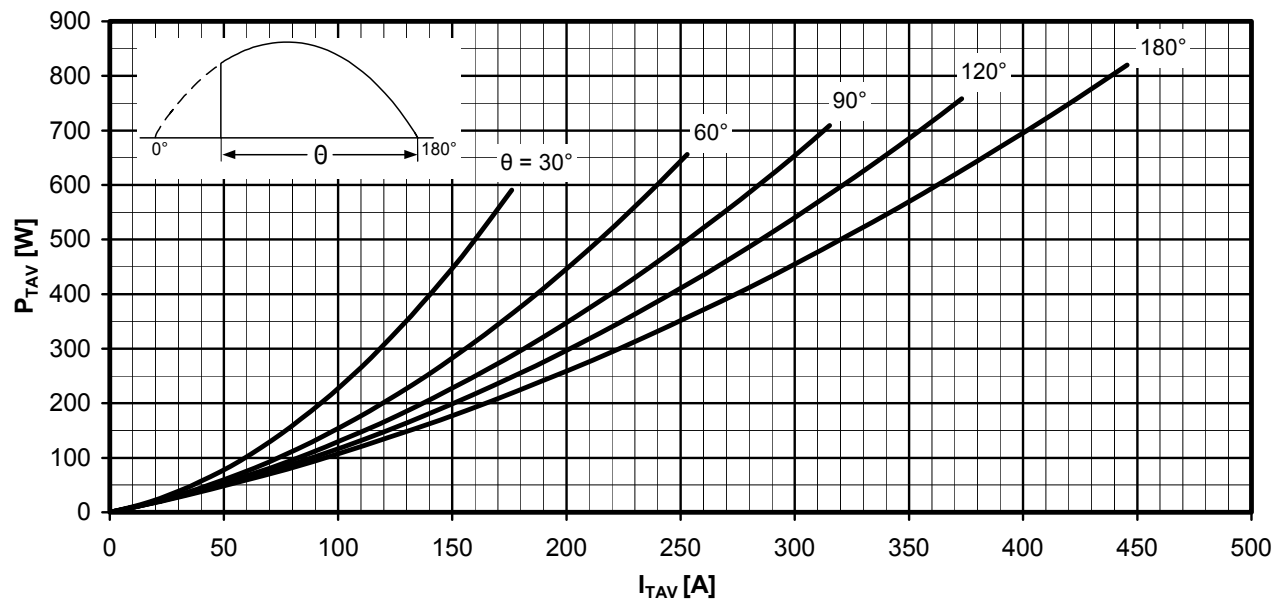

Durchlaßverlustleistung / On-state power loss $P_{TAV} = f(I_{TAV})$

Sinusförmiger Strom / Sinusoidal current

Parameter: Stromflußwinkel Θ / Current conduction angle Θ

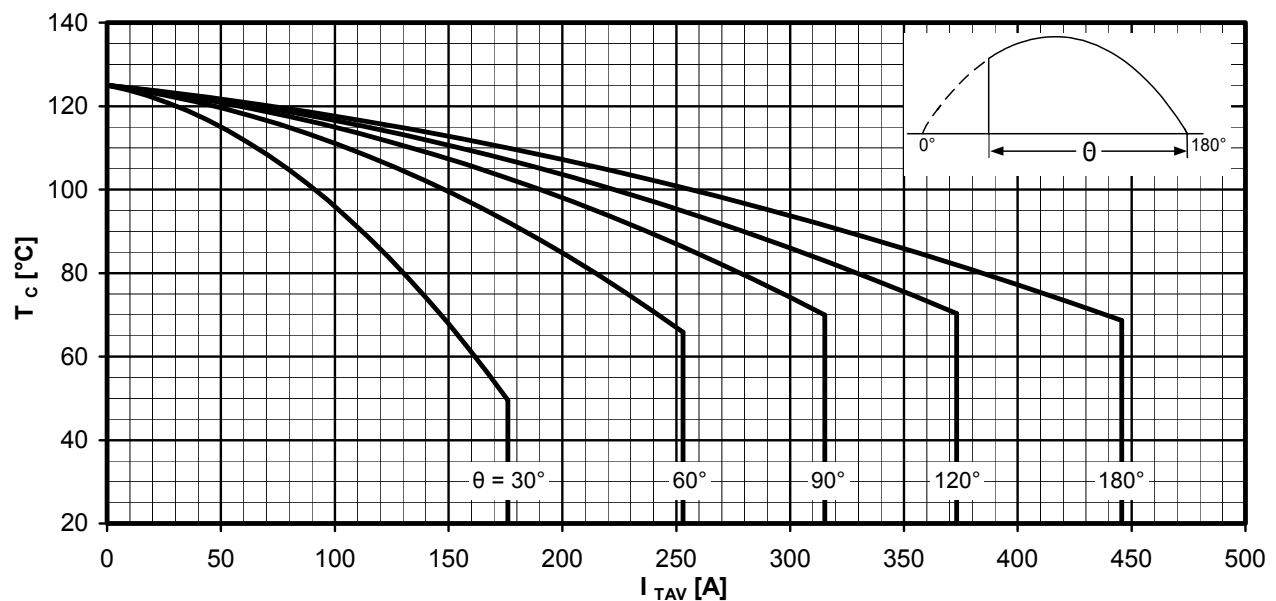

Höchstzulässige Gehäusetemperatur / Maximum allowable case temperature $T_c = f(I_{TAV})$

Sinusförmiger Strom / Sinusoidal current

Beidseitige Kühlung / Two-sided cooling

Parameter: Stromflußwinkel Θ / Current conduction angle Θ

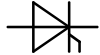

Netz-Thyristor
Phase Control Thyristor

T358N

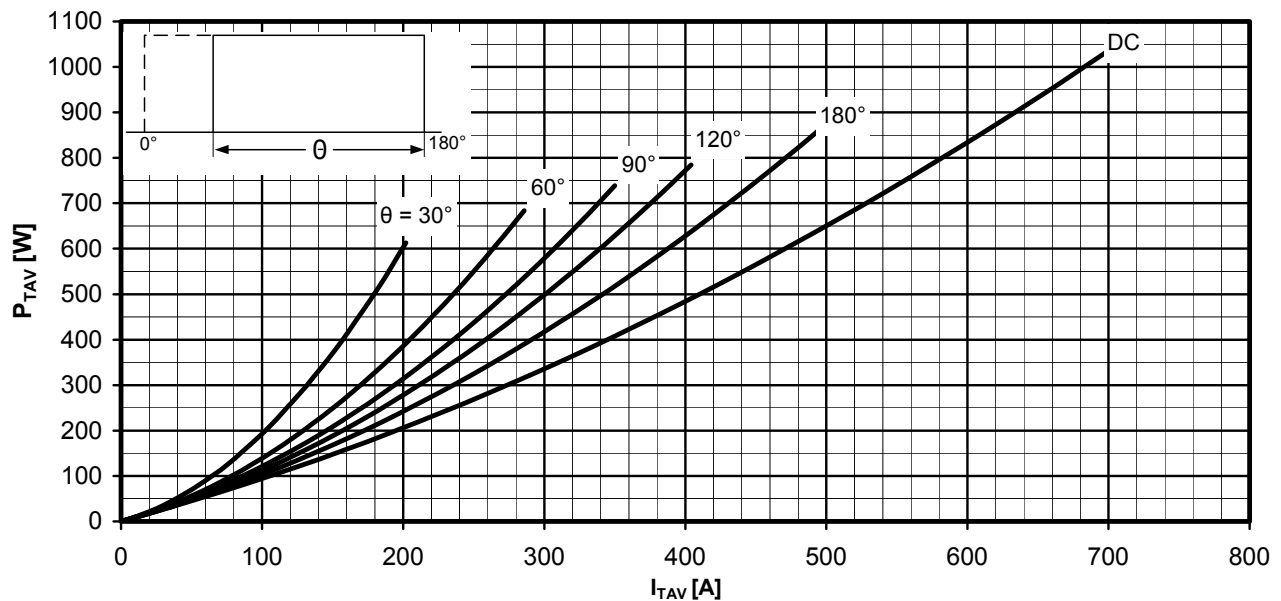

Durchlaßverlustleistung / On-state power loss $P_{TAV} = f(I_{TAV})$

Rechteckförmiger Strom / Rectangular current

Parameter: Stromflußwinkel Θ / Current conduction angle Θ

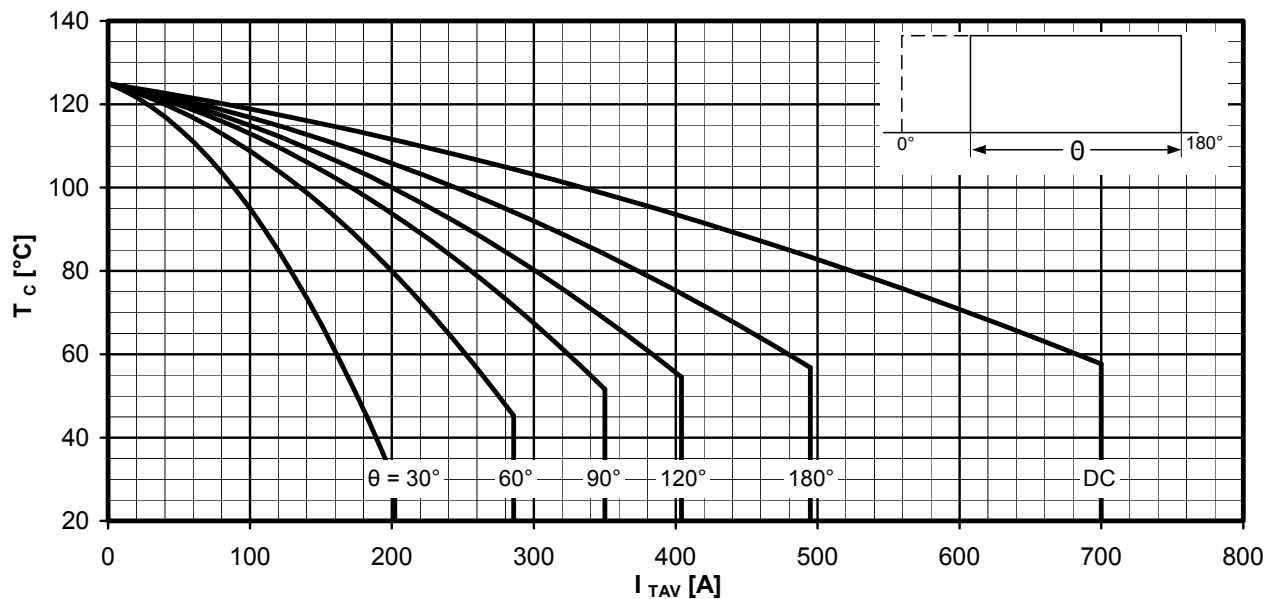

Höchstzulässige Gehäusetemperatur / Maximum allowable case temperature $T_c = f(I_{TAV})$

Rechteckförmiger Strom / Rectangular current

Beidseitige Kühlung / Two-sided cooling

Parameter: Stromflußwinkel Θ / Current conduction angle Θ

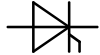

Netz-Thyristor
Phase Control Thyristor

T358N

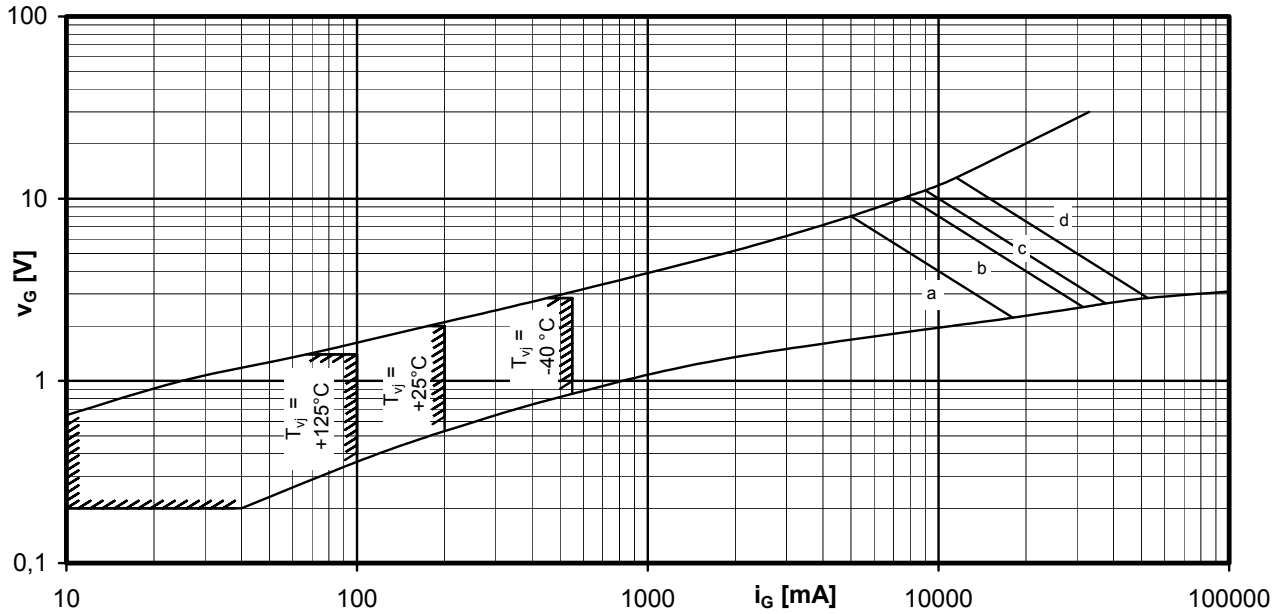

Steuercharakteristik $v_G = f(i_G)$ mit Zündbereichen für $V_D = 12\text{ V}$
Gate characteristic $v_G = f(i_G)$ with triggering area for $V_D = 12\text{ V}$

Höchstzulässige Spitzensteuerverlustleistung / Maximum rated peak gate power dissipation $P_{GM} = f(t_g)$:

a - 40W / 10ms b - 80W / 1ms c - 100W / 0,5ms d - 150W / 0,1ms

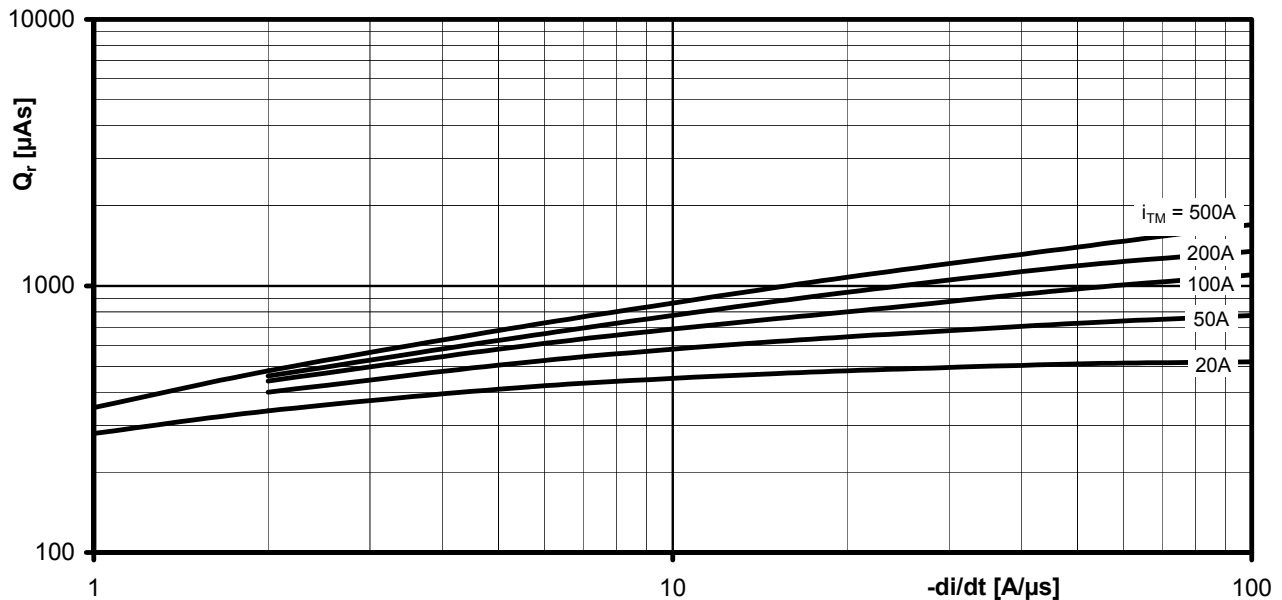

Sperrverzögerungsladung / Recovered charge $Q_r = f(di/dt)$

$T_{vj} = T_{vjmax}$, $v_R \leq 0,5 V_{RRM}$, $v_{RM} = 0,8 V_{RRM}$

Parameter: Durchlaßstrom / On-state current i_{TM}

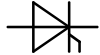

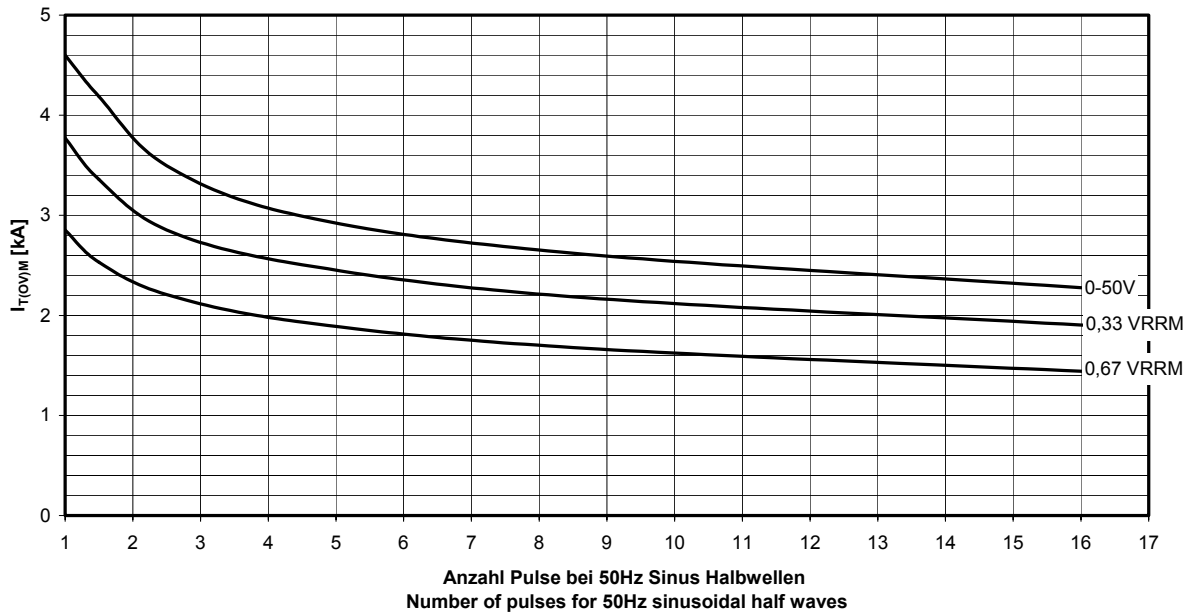

Netz-Thyristor
Phase Control Thyristor

T358N



Typische Abhängigkeit des Grenzstromes $I_{T(OV)M}$ von der Anzahl für eine Folge von Sinus Halbwellen bei 50Hz. Parameter: Rückwärtsspannung V_{RM}
 Typical dependency of maximum overload on-state current $I_{T(OV)M}$ as a number of a sequence of sinusoidal half waves at 50Hz. Parameter: peak reverse voltage V_{RM}
 $I_{T(OV)M} = f(\text{pulses}, V_{RM}) ; T_{vj} = T_{vjmax}$

N		Datenblatt / Data sheet	
Netz-Thyristor Phase Control Thyristor		T358N	
<p>Nutzungsbedingungen</p> <p>Die in diesem Produktdatenblatt enthaltenen Daten sind ausschließlich für technisch geschultes Fachpersonal bestimmt. Die Beurteilung der Geeignetheit dieses Produktes für die von Ihnen anvisierte Anwendung sowie die Beurteilung der Vollständigkeit der bereitgestellten Produktdaten für diese Anwendung obliegt Ihnen bzw. Ihren technischen Abteilungen.</p> <p>In diesem Produktdatenblatt werden diejenigen Merkmale beschrieben, für die wir eine liefervertragliche Gewährleistung übernehmen. Eine solche Gewährleistung richtet sich ausschließlich nach Maßgabe der im jeweiligen Liefervertrag enthaltenen Bestimmungen. Garantien jeglicher Art werden für das Produkt und dessen Eigenschaften keinesfalls übernommen.</p> <p>Sollten Sie von uns Produktinformationen benötigen, die über den Inhalt dieses Produktdatenblatts hinausgehen und insbesondere eine spezifische Verwendung und den Einsatz dieses Produktes betreffen, setzen Sie sich bitte mit dem für Sie zuständigen Vertriebsbüro in Verbindung (siehe www.eupec.com, Vertrieb&Kontakt). Für Interessenten halten wir Application Notes bereit.</p> <p>Aufgrund der technischen Anforderungen könnte unser Produkt gesundheitsgefährdende Substanzen enthalten. Bei Rückfragen zu den in diesem Produkt jeweils enthaltenen Substanzen setzen Sie sich bitte ebenfalls mit dem für Sie zuständigen Vertriebsbüro in Verbindung.</p> <p>Sollten Sie beabsichtigen, das Produkt in Anwendungen der Luftfahrt, in gesundheits- oder lebensgefährdenden oder lebenserhaltenden Anwendungsbereichen einzusetzen, bitten wir um Mitteilung. Wir weisen darauf hin, dass wir für diese Fälle</p> <ul style="list-style-type: none"> - die gemeinsame Durchführung eines Risiko- und Qualitätsassessments; - den Abschluss von speziellen Qualitätssicherungsvereinbarungen; - die gemeinsame Einführung von Maßnahmen zu einer laufenden Produktbeobachtung dringend empfehlen und gegebenenfalls die Belieferung von der Umsetzung solcher Maßnahmen abhängig machen. <p>Soweit erforderlich, bitten wir Sie, entsprechende Hinweise an Ihre Kunden zu geben.</p> <p>Inhaltliche Änderungen dieses Produktdatenblatts bleiben vorbehalten.</p> <p>Terms & Conditions of usage</p> <p>The data contained in this product data sheet is exclusively intended for technically trained staff. You and your technical departments will have to evaluate the suitability of the product for the intended application and the completeness of the product data with respect to such application.</p> <p>This product data sheet is describing the characteristics of this product for which a warranty is granted. Any such warranty is granted exclusively pursuant the terms and conditions of the supply agreement. There will be no guarantee of any kind for the product and its characteristics.</p> <p>Should you require product information in excess of the data given in this product data sheet or which concerns the specific application of our product, please contact the sales office, which is responsible for you (see www.eupec.com, sales&contact). For those that are specifically interested we may provide application notes.</p> <p>Due to technical requirements our product may contain dangerous substances. For information on the types in question please contact the sales office, which is responsible for you.</p> <p>Should you intend to use the Product in aviation applications, in health or live endangering or life support applications, please notify. Please note, that for any such applications we urgently recommend</p> <ul style="list-style-type: none"> - to perform joint Risk and Quality Assessments; - the conclusion of Quality Agreements; - to establish joint measures of an ongoing product survey, and that we may make delivery depended on the realization of any such measures. <p>If and to the extent necessary, please forward equivalent notices to your customers.</p> <p>Changes of this product data sheet are reserved.</p>			
A 513 MT3 / 20.01.88, K.-A. Rüter	A 10/88	Seite/page	10/10