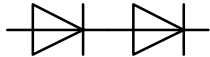

**N****Datenblatt / Data sheet**

power electronics in motion

**eupec****Netz-Dioden-Modul  
Rectifier Diode Module****DD700N**Vorläufige Daten  
Preliminary data**DD700N****Elektrische Eigenschaften / Electrical properties**

Höchstzulässige Werte / Maximum rated values

Periodische Spitzensperrspannung repetitive peak reverse voltages	$T_{vj} = -40^{\circ}\text{C} \dots T_{vj\text{ max}}$	$V_{RRM}$	1800	2000 2200	V V
Stoßspitzensperrspannung non-repetitive peak reverse voltage	$T_{vj} = +25^{\circ}\text{C} \dots T_{vj\text{ max}}$	$V_{RSM}$	1900	2100 2300	V V
Durchlaßstrom-Grenzeffektivwert maximum RMS on-state current		$I_{FRMSM}$		1100	A
Dauergrenzstrom average on-state current	$T_C = 100^{\circ}\text{C}$	$I_{FAVM}$		700	A
Stoßstrom-Grenzwert surge current	$T_{vj} = 25^{\circ}\text{C}, t_p = 10\text{ ms}$ $T_{vj} = T_{vj\text{ max}}, t_p = 10\text{ ms}$	$I_{FSM}$		25.000 21.000	A A
Grenzlastintegral $I^2t$ -value	$T_{vj} = 25^{\circ}\text{C}, t_p = 10\text{ ms}$ $T_{vj} = T_{vj\text{ max}}, t_p = 10\text{ ms}$	$I^2t$		3.125.000 2.205.000	A <sup>2</sup> s A <sup>2</sup> s

Charakteristische Werte / Characteristic values

Durchlaßspannung on-state voltage	$T_{vj} = T_{vj\text{ max}}, I_F = 2200\text{ A}$	$V_F$	max.	1,36	V
Schleusenspannung threshold voltage	$T_{vj} = T_{vj\text{ max}}$	$V_{(TO)}$		0,78	V
Ersatzwiderstand slope resistance	$T_{vj} = T_{vj\text{ max}}$	$r_T$		0,185	m $\Omega$
Sperrstrom reverse current	$T_{vj} = T_{vj\text{ max}}, V_R = V_{RRM}$	$i_R$	max.	50	mA
Isolations-Prüfspannung insulation test voltage	RMS, $f = 50\text{ Hz}, t = 1\text{ sec}$ RMS, $f = 50\text{ Hz}, t = 1\text{ min}$	$V_{ISOL}$		3,6 3,0	kV kV

**Thermische Eigenschaften / Thermal properties**

Innerer Wärmewiderstand thermal resistance, junction to case	pro Modul / per Module, $\Theta = 180^{\circ}\text{ sin}$ pro Zweig / per arm, $\Theta = 180^{\circ}\text{ sin}$ pro Modul / per Module, DC pro Zweig / per arm, DC	$R_{thJC}$	max.	0,0325 0,0650 0,0310 0,0620	$^{\circ}\text{C/W}$ $^{\circ}\text{C/W}$ $^{\circ}\text{C/W}$ $^{\circ}\text{C/W}$
Übergangs-Wärmewiderstand thermal resistance, case to heatsink	pro Modul / per Module pro Zweig / per arm	$R_{thCH}$	max.	0,01 0,02	$^{\circ}\text{C/W}$ $^{\circ}\text{C/W}$
Höchstzulässige Sperrschichttemperatur maximum junction temperature		$T_{vj\text{ max}}$		150	$^{\circ}\text{C}$
Betriebstemperatur operating temperature		$T_{c\text{ op}}$		- 40...+150	$^{\circ}\text{C}$
Lagertemperatur storage temperature		$T_{stg}$		- 40...+150	$^{\circ}\text{C}$

prepared by:	C. Drilling	date of publication:	17.12.04
approved by:	M. Leifeld	revision:	1

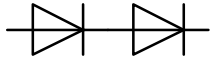
**N****Datenblatt / Data sheet**
 power electronics in motion  
**eupec**
**Netz-Dioden-Modul**  
**Rectifier Diode Module**
**DD700N**
 Vorläufige Daten  
 Preliminary data

**Mechanische Eigenschaften / Mechanical properties**

Gehäuse, siehe Anlage case, see annex			Seite 3 page 3	
Si-Element mit Druckkontakt Si-pellet with pressure contact				
Innere Isolation internal insulation			AIN	
Anzugsdrehmoment für mechanische Anschlüsse mounting torque	Toleranz $\pm 15\%$	M1	6	Nm
Anzugsdrehmoment für elektrische Anschlüsse terminal connection torque	Toleranz $\pm 10\%$	M2	12	Nm
Gewicht weight		G	typ. 1500	g
Kriechstrecke creepage distance			19	mm
Schwingfestigkeit vibration resistance	f = 50 Hz		50	m/s <sup>2</sup>

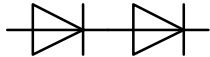
**N**

# Datenblatt / Data sheet

power electronics in motion

**eupec**
**Netz-Dioden-Modul**  
**Rectifier Diode Module**

## DD700N

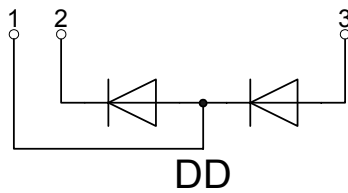
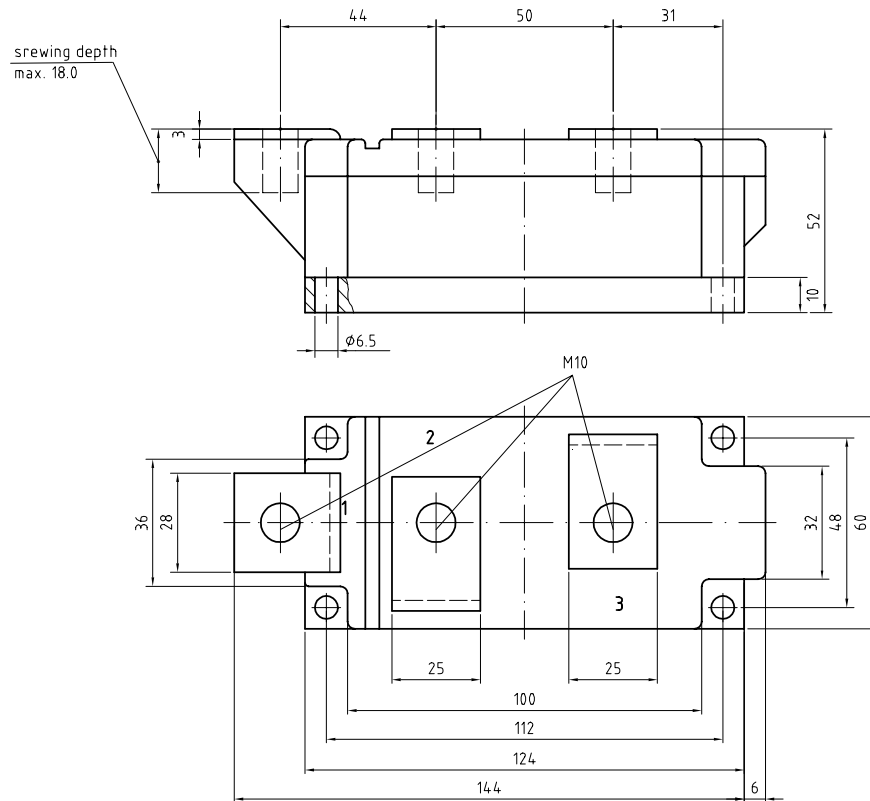
 Vorläufige Daten  
 Preliminary data

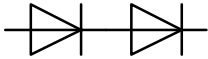

**Analytische Elemente des transienten Wärmewiderstandes  $Z_{thJC}$  für DC**  
**Analytical elements of transient thermal impedance  $Z_{thJC}$  for DC**

Pos. n	1	2	3	4	5	6	7
$R_{thn}$ [°C/W]	0,00137	0,00486	0,0114	0,0223	0,0221		
$T_n$ [s]	0,00076	0,0086	0,101	0,56	3,12		

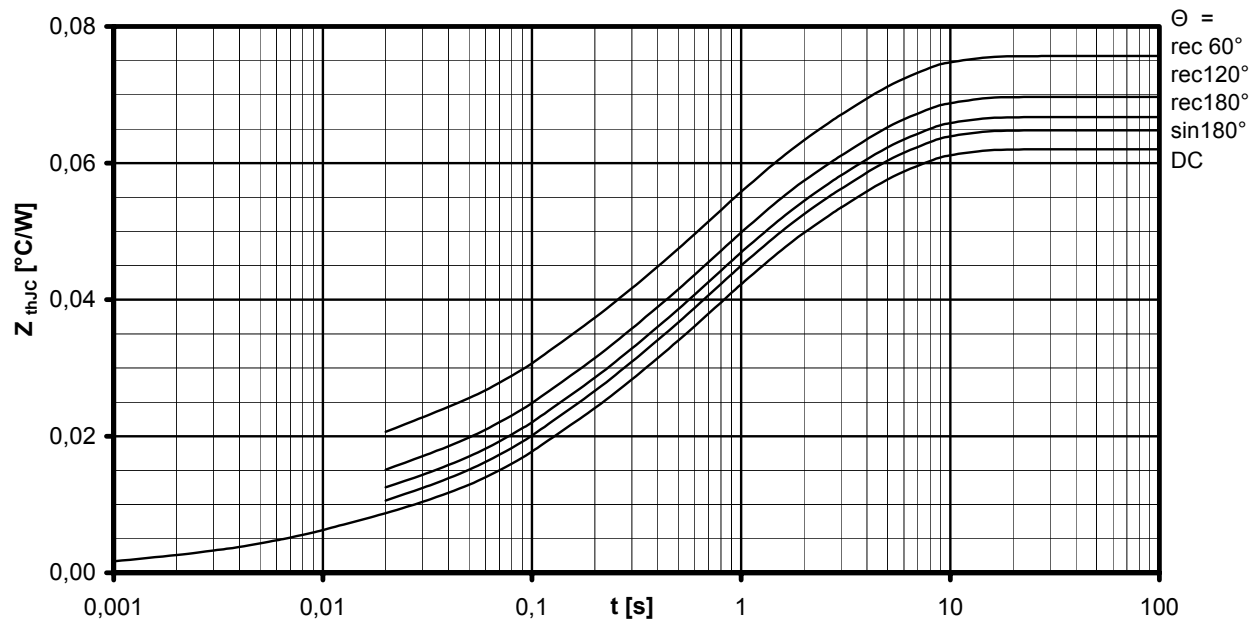
Analytische Funktion / Analytical function: 
$$Z_{thJC} = \sum_{n=1}^{n_{max}} R_{thn} \left( 1 - e^{-\frac{t}{\tau_n}} \right)$$



Transienter innerer Wärmewiderstand je Zweig / Transient thermal impedance per arm  $Z_{thJC} = f(t)$

Parameter: Stromflußwinkel  $\Theta$  / Current conduction angle  $\Theta$

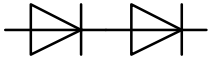
Netz-Dioden-Modul  
Rectifier Diode Module**DD700N**Vorläufige Daten  
Preliminary data

Natürliche Kühlung / Natural cooling  
1 Module pro Kühler / 1 modules per heatsink  
Kühler / Heatsink type: KM17 (160W)

**Analytische Elemente des transienten Wärmewiderstandes  $Z_{thCA}$**   
**Analytical elements of transient thermal impedance  $Z_{thCA}$**

Pos. n	1	2	3	4	5	6	7
$R_{thn}$ [°C/W]	0,00672	0,0537	0,539				
$T_n$ [s]	2,17	22,4	1130				

Verstärkte Kühlung / Forced cooling  
1 Module pro Kühler / 1 modules per heatsink  
Kühler / Heatsink type: KM17 (Papst 4650)

**Analytische Elemente des transienten Wärmewiderstandes  $Z_{thCA}$**   
**Analytical elements of transient thermal impedance  $Z_{thCA}$**

Pos. n	1	2	3	4	5	6	7
$R_{thn}$ [°C/W]	0,0064	0,0566	0,168				
$T_n$ [s]	4,1	24,7	395				

Analytische Funktion / Analytical function:

$$Z_{thCA} = \sum_{n=1}^{n_{max}} R_{thn} \left( 1 - e^{-\frac{t}{\tau_n}} \right)$$

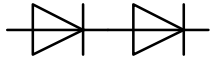

Netz-Dioden-Modul  
Rectifier Diode Module

**DD700N**

Vorläufige Daten  
Preliminary data

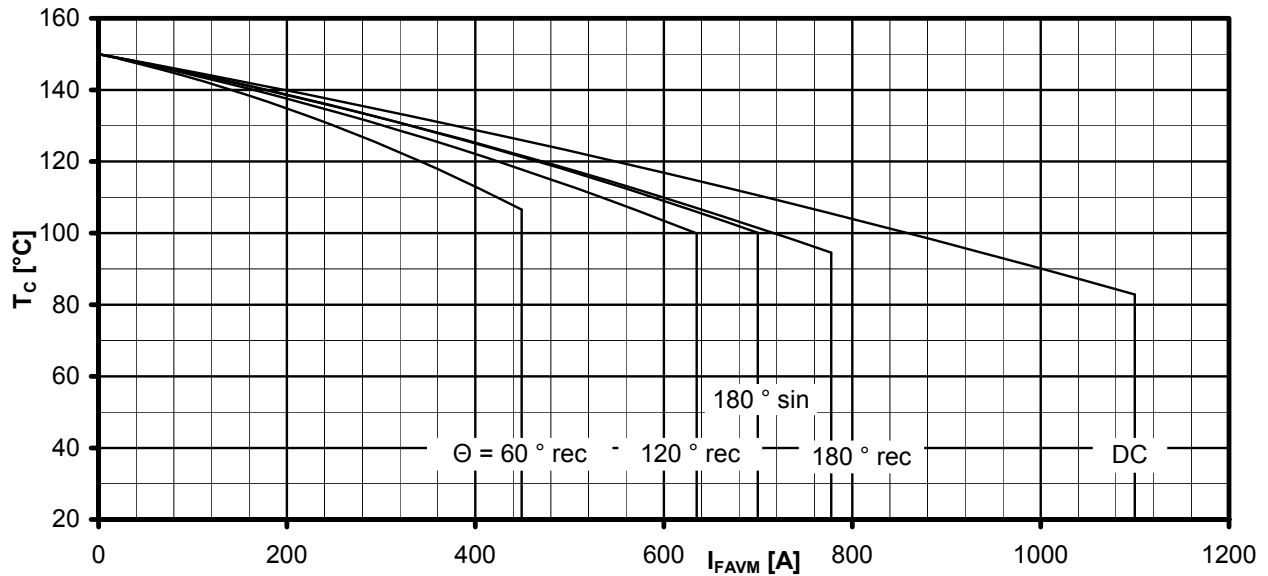

Durchlassverlustleistung je Zweig / On-state power loss per arm  $P_{FAV} = f(I_{FAV})$

Parameter: Stromflußwinkel / Current conduction angle  $\Theta$

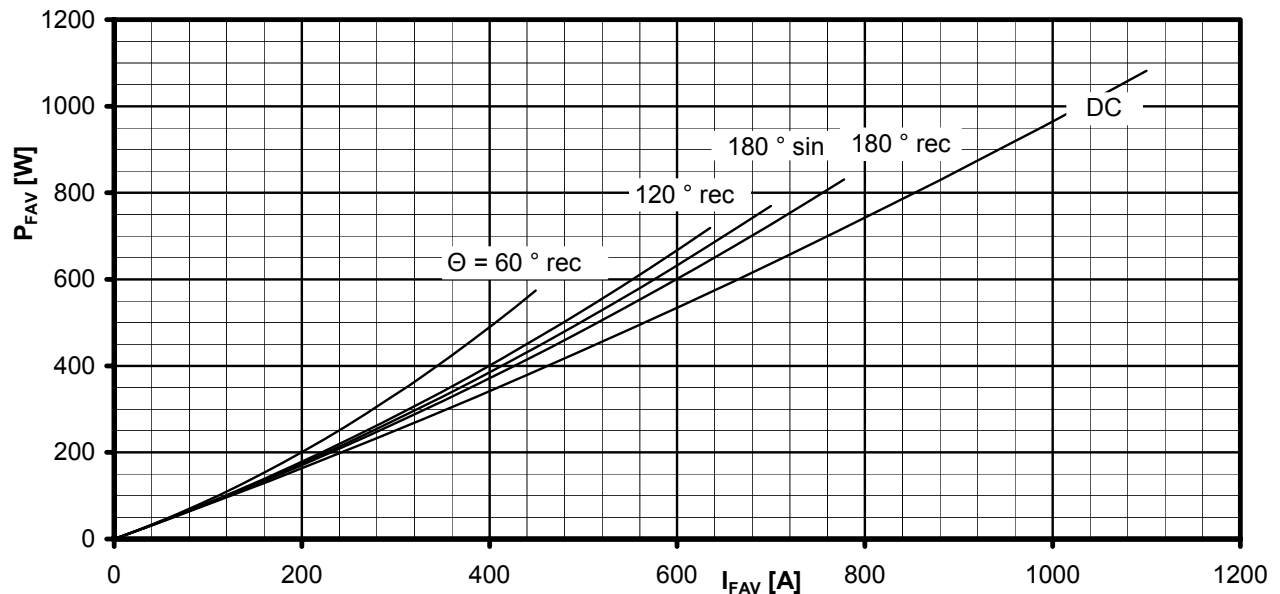

Höchstzulässige Gehäusetemperatur / Maximum allowable case temperature  $T_c = f(I_{FAVM})$

Strombelastung je Zweig / Current load per arm

**Berechnungsgrundlage  $P_{TAV}$**  (Schaltverluste gesondert berücksichtigen)  
**Calculation base  $P_{TAV}$**  (switching losses should be considered separately)

Parameter: Stromflußwinkel  $\Theta$  / Current conduction angle  $\Theta$

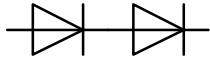

Netz-Dioden-Modul  
Rectifier Diode Module

**DD700N**

Vorläufige Daten  
Preliminary data

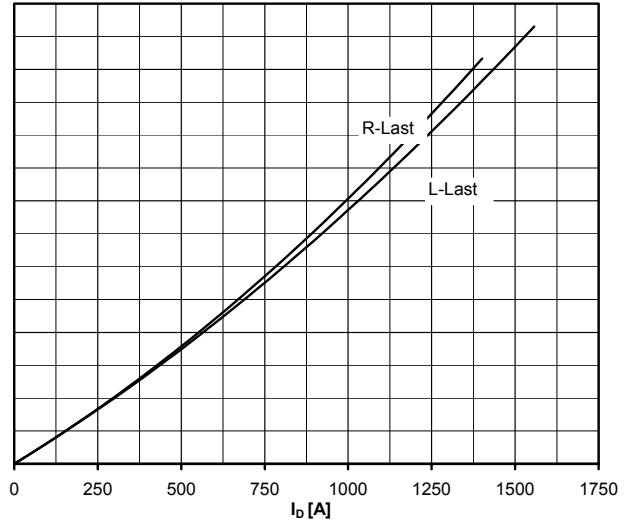
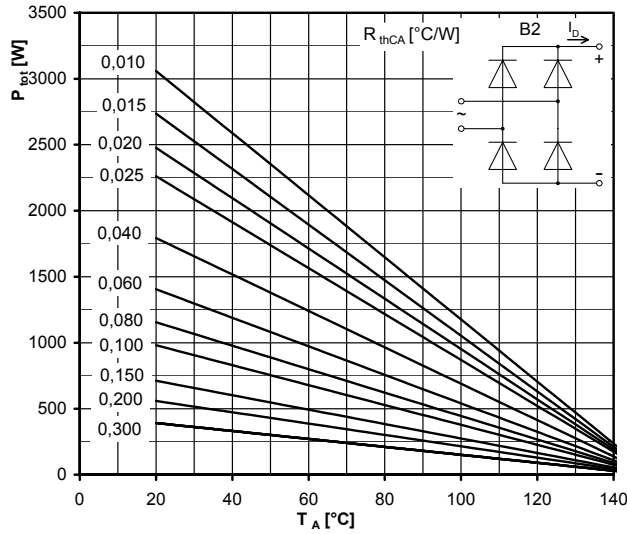

**Höchstzulässiger Ausgangsstrom / Maximum rated output current  $I_b$**

B2- Zweipuls-Brückenschaltung / Two-pulse bridge circuit

Gesamtverlustleistung der Schaltung / Total power dissipation at circuit  $P_{tot}$

Parameter:

Wärmewiderstand zwischen den Gehäusen und Umgebung / Thermal resistance cases to ambient  $R_{thCA}$

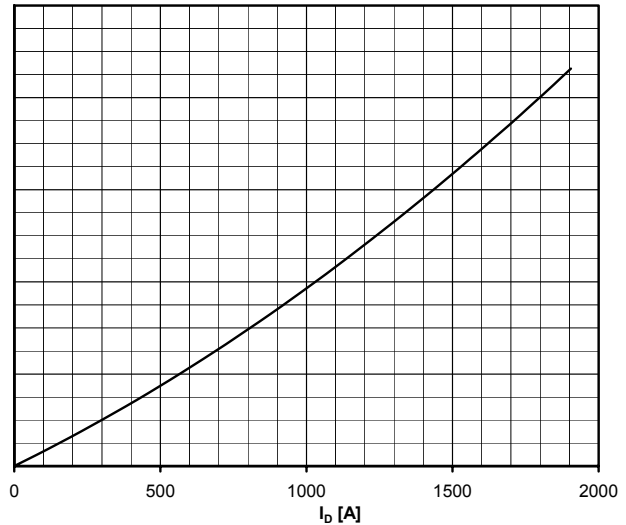
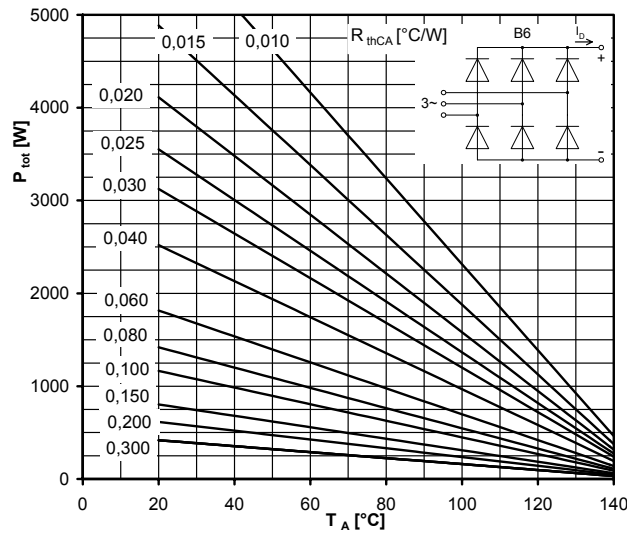

**Höchstzulässiger Ausgangsstrom / Maximum rated output current  $I_b$**

B6- Sechspuls-Brückenschaltung / Six-pulse bridge circuit

Gesamtverlustleistung der Schaltung / Total power dissipation at circuit  $P_{tot}$

Parameter:

Wärmewiderstand zwischen den Gehäusen und Umgebung / Thermal resistance cases to ambient  $R_{thCA}$

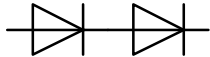
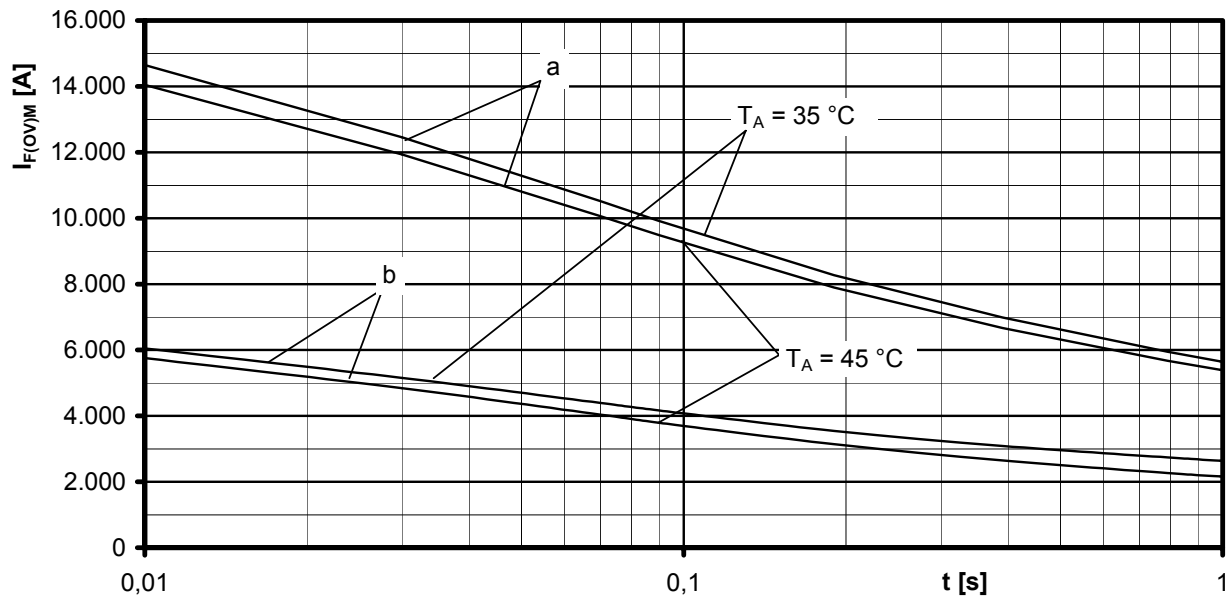
Netz-Dioden-Modul  
Rectifier Diode Module**DD700N**Vorläufige Daten  
Preliminary dataGrenzstrom je Zweig / Maximum overload on-state current per arm  $I_{F(OV)M} = f(t)$ ,  $V_{RM} = 0,8 V_{RRM}$ 

a: Leerlauf / No-load conditions

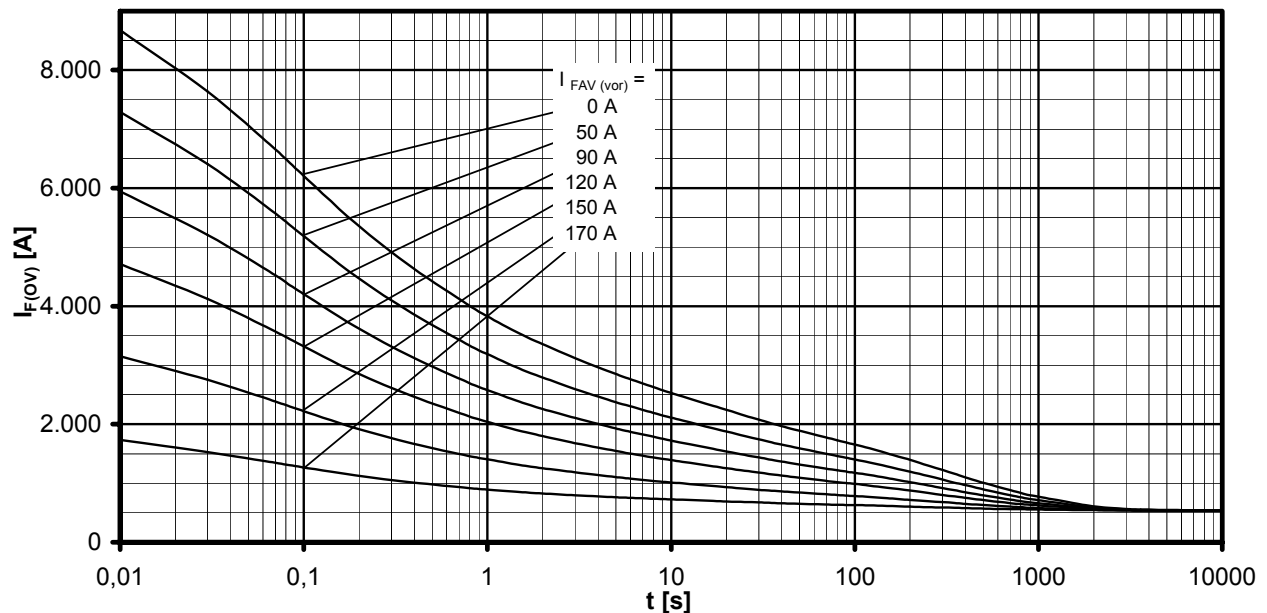
b: Vorlaststrom je Zweig / Pre-load current per arm  $I_{FAV(vor)} = I_{FAVM}$  $T_a = 35^\circ\text{C}$ , verstärkte Luftkühlung / Forced air cooling    Kühlkörper / Heatsink type: KM17 (Papst 4650) $T_a = 45^\circ\text{C}$ , natürliche Luftkühlung / Natural air cooling    Kühlkörper / Heatsink type: KM17 (160W)Überstrom je Zweig / Overload on-state current  $I_{F(OV)}$ B6- Sechspuls-Brückenschaltung,  $120^\circ$  Rechteck / Six-pulse bridge circuit,  $120^\circ$  rectangularKühlkörper / Heatsink type KM17 (160W)    Natürliche Kühlung bei / Natural cooling at  $T_a = 45^\circ\text{C}$ Parameter: Vorlaststrom je Zweig / Pre-load current per arm  $I_{FAV(vor)}$

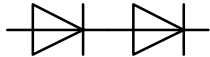
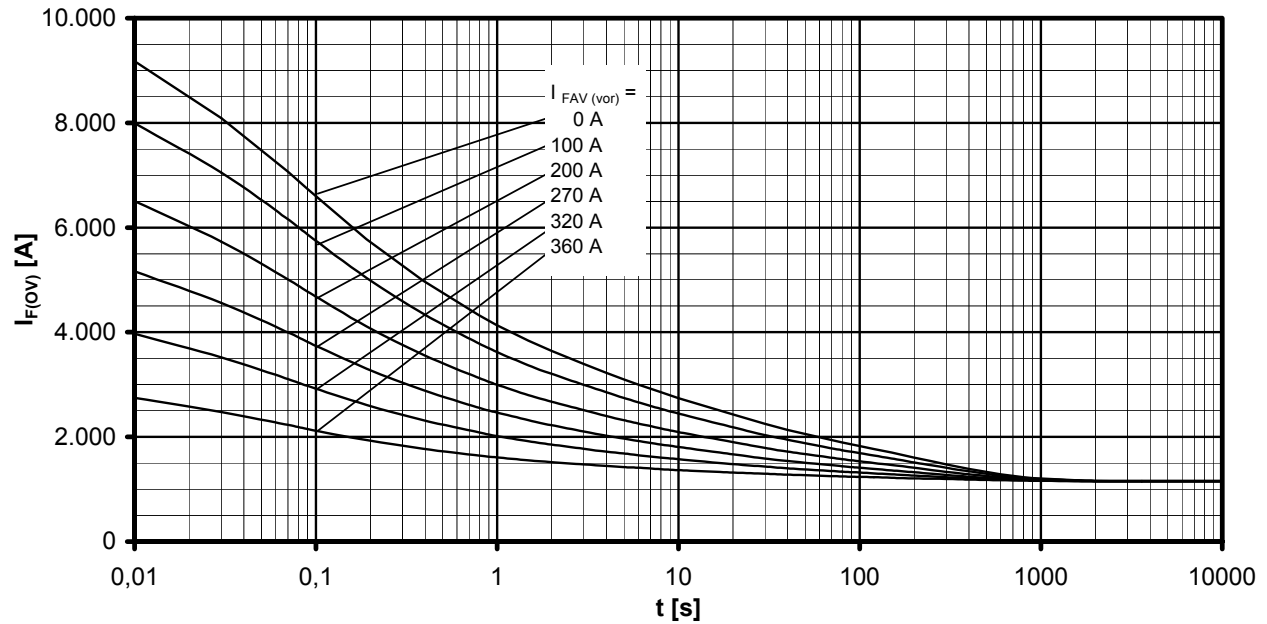

Netz-Dioden-Modul  
Rectifier Diode Module**DD700N**Vorläufige Daten  
Preliminary dataÜberstrom je Zweig / Overload on-state current  $I_{F(OV)}$ 

B6- Sechspuls-Brückenschaltung, 120° Rechteck / Six-pulse bridge circuit 120° rectangular

Kühlkörper / Heatsink type KM17 (Papst 4650) Verstärkte Kühlung bei / Forced cooling at  $T_A = 35^\circ\text{C}$ Parameter: Vorlaststrom je Zweig / Pre-load current per arm  $I_{FAV(vor)}$

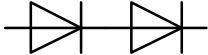
<b>N</b>		<b>Datenblatt / Data sheet</b>	power electronics in motion <b>eupec</b>
<b>Netz-Dioden-Modul</b> <b>Rectifier Diode Module</b>	<b>DD700N</b>		Vorläufige Daten Preliminary data
<p><b>Nutzungsbedingungen</b></p> <p>Die in diesem Produktdatenblatt enthaltenen Daten sind ausschließlich für technisch geschultes Fachpersonal bestimmt. Die Beurteilung der Eignung dieses Produktes für Ihre Anwendung sowie die Beurteilung der Vollständigkeit der bereitgestellten Produktdaten für diese Anwendung obliegt Ihnen bzw. Ihren technischen Abteilungen.</p> <p>In diesem Produktdatenblatt werden diejenigen Merkmale beschrieben, für die wir eine liefervertragliche Gewährleistung übernehmen. Eine solche Gewährleistung richtet sich ausschließlich nach Maßgabe der im jeweiligen Liefervertrag enthaltenen Bestimmungen. Garantien jeglicher Art werden für das Produkt und dessen Eigenschaften keinesfalls übernommen.</p> <p>Sollten Sie von uns Produktinformationen benötigen, die über den Inhalt dieses Produktdatenblatts hinausgehen und insbesondere eine spezifische Verwendung und den Einsatz dieses Produktes betreffen, setzen Sie sich bitte mit dem für Sie zuständigen Vertriebsbüro in Verbindung (siehe <a href="http://www.eupec.com">www.eupec.com</a>, Vertrieb&amp;Kontakt). Für Interessenten halten wir Application Notes bereit.</p> <p>Aufgrund der technischen Anforderungen könnte unser Produkt gesundheitsgefährdende Substanzen enthalten. Bei Rückfragen zu den in diesem Produkt jeweils enthaltenen Substanzen setzen Sie sich bitte ebenfalls mit dem für Sie zuständigen Vertriebsbüro in Verbindung.</p> <p>Sollten Sie beabsichtigen, das Produkt in gesundheits- oder lebensgefährdenden oder lebenserhaltenden Anwendungsbereichen einzusetzen, bitten wir um Mitteilung. Wir weisen darauf hin, dass wir für diese Fälle</p> <ul style="list-style-type: none"> <li>- die gemeinsame Durchführung eines Risiko- und Qualitätsassessments;</li> <li>- den Abschluss von speziellen Qualitätssicherungsvereinbarungen;</li> <li>- die gemeinsame Einführung von Maßnahmen zu einer laufenden Produktbeobachtung dringend empfehlen und gegebenenfalls die Belieferung von der Umsetzung solcher Maßnahmen abhängig machen.</li> </ul> <p>Soweit erforderlich, bitten wir Sie, entsprechende Hinweise an Ihre Kunden zu geben.</p> <p>Inhaltliche Änderungen dieses Produktdatenblatts bleiben vorbehalten.</p> <p><b>Terms &amp; Conditions of usage</b></p> <p>The data contained in this product data sheet is exclusively intended for technically trained staff. You and your technical departments will have to evaluate the suitability of the product for the intended application and the completeness of the product data with respect to such application.</p> <p>This product data sheet is describing the characteristics of this product for which a warranty is granted. Any such warranty is granted exclusively pursuant the terms and conditions of the supply agreement. There will be no guarantee of any kind for the product and its characteristics.</p> <p>Should you require product information in excess of the data given in this product data sheet or which concerns the specific application of our product, please contact the sales office, which is responsible for you (see <a href="http://www.eupec.com">www.eupec.com</a>, sales&amp;contact). For those that are specifically interested we may provide application notes. Due to technical requirements our product may contain dangerous substances. For information on the types in question please contact the sales office, which is responsible for you.</p> <p>Should you intend to use the Product in health or live endangering or life support applications, please notify. Please note, that for any such applications we urgently recommend</p> <ul style="list-style-type: none"> <li>- to perform joint Risk and Quality Assessments;</li> <li>- the conclusion of Quality Agreements;</li> <li>- to establish joint measures of an ongoing product survey, and that we may make delivery depended on the realization of any such measures.</li> </ul> <p>If and to the extent necessary, please forward equivalent notices to your customers.</p> <p>Changes of this product data sheet are reserved.</p>			
BIP AC / 04-12-17, C. Drilling	A17/04	Rev. 1	Seite/page 10/10