

hochisolierendes Modul
high insulated module

Vorläufige Daten / preliminary data

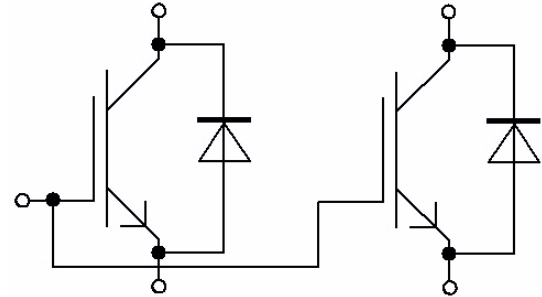

$V_{CES} = 6500V$
 $I_{C\ nom} = 500A / I_{CRM} = 1000A$

Typische Anwendungen

- Mittelspannungsantriebe
- Traktionsumrichter

Typical Applications

- Medium Voltage Converters
- Traction Drives

Elektrische Eigenschaften

- Niedriges V_{CEsat}

Electrical Features

- LOW V_{CEsat}

Mechanische Eigenschaften

- AISiC Bodenplatte für erhöhte thermische Lastwechselfestigkeit
- Gehäuse mit CTI > 600
- Gehäuse mit erweiterten Isolationseigenschaften von 10,2kV AC 1min
- Große Luft- und Kriechstrecken

Mechanical Features

- AISiC Base Plate for increased Thermal Cycling Capability
- Package with CTI > 600
- Package with enhanced Insulation of 10.2kV AC 1min
- High Creepage and Clearance Distances

Module Label Code

Barcode Code 128



DMX - Code



Content of the Code

Content of the Code	Digit
Module Serial Number	1 - 5
Module Material Number	6 - 11
Production Order Number	12 - 19
Datecode (Production Year)	20 - 21
Datecode (Production Week)	22 - 23

prepared by: TH	date of publication: 2010-12-13	material no: 29818
approved by: TS	revision: 2.0	UL approved (E83335)

Technische Information / technical information

IGBT-Module
IGBT-modules

FZ500R65KE3



Vorläufige Daten preliminary data

IGBT-Wechselrichter / IGBT-inverter

Höchstzulässige Werte / maximum rated values

Kollektor-Emitter-Sperrspannung collector-emitter voltage	$T_{vj} = 125^{\circ}\text{C}$ $T_{vj} = 25^{\circ}\text{C}$ $T_{vj} = -40^{\circ}\text{C}$	V_{CES}	6500 6500 6000	V
Kollektor-Dauergleichstrom DC-collector current	$T_C = 80^{\circ}\text{C}$, $T_{vj} = 150^{\circ}\text{C}$	$I_{C\text{ nom}}$	500	A
Periodischer Kollektor Spitzenstrom repetitive peak collector current	$t_p = 1\text{ ms}$	I_{CRM}	1000	A
Gesamt-Verlustleistung total power dissipation	$T_C = 25^{\circ}\text{C}$, $T_{vj} = 150^{\circ}\text{C}$	P_{tot}	9,60	kW
Gate-Emitter-Spitzenspannung gate-emitter peak voltage		V_{GES}	+/-20	V

Charakteristische Werte / characteristic values

			min.	typ.	max.	
Kollektor-Emitter Sättigungsspannung collector-emitter saturation voltage	$I_C = 500\text{ A}$, $V_{GE} = 15\text{ V}$ $I_C = 500\text{ A}$, $V_{GE} = 15\text{ V}$	$T_{vj} = 25^{\circ}\text{C}$ $T_{vj} = 125^{\circ}\text{C}$	$V_{CE\text{ sat}}$	3,00 3,70	3,40	V V
Gate-Schwellenspannung gate threshold voltage	$I_C = 70,0\text{ mA}$, $V_{CE} = V_{GE}$, $T_{vj} = 25^{\circ}\text{C}$		$V_{GE\text{ th}}$	5,4	6,0	6,6 V
Gateladung gate charge	$V_{GE} = -15\text{ V} \dots +15\text{ V}$, $V_{CE} = 3600\text{ V}$		Q_G	20,0		μC
Interner Gatewiderstand internal gate resistor	$T_{vj} = 25^{\circ}\text{C}$		$R_{G\text{int}}$	1,1		Ω
Eingangskapazität input capacitance	$f = 1\text{ MHz}$, $T_{vj} = 25^{\circ}\text{C}$, $V_{CE} = 25\text{ V}$, $V_{GE} = 0\text{ V}$		C_{ies}	135		nF
Rückwirkungskapazität reverse transfer capacitance	$f = 1\text{ MHz}$, $T_{vj} = 25^{\circ}\text{C}$, $V_{CE} = 25\text{ V}$, $V_{GE} = 0\text{ V}$		C_{res}	2,10		nF
Kollektor-Emitter Reststrom collector-emitter cut-off current	$V_{CE} = 6500\text{ V}$, $V_{GE} = 0\text{ V}$, $T_{vj} = 25^{\circ}\text{C}$		I_{CES}		5,0	mA
Gate-Emitter Reststrom gate-emitter leakage current	$V_{CE} = 0\text{ V}$, $V_{GE} = 20\text{ V}$, $T_{vj} = 25^{\circ}\text{C}$		I_{GES}		400	nA
Einschaltverzögerungszeit (ind. Last) turn-on delay time (inductive load)	$I_C = 500\text{ A}$, $V_{CE} = 3600\text{ V}$ $V_{GE} = \pm 15\text{ V}$ $R_{G\text{on}} = 1,5\ \Omega$	$T_{vj} = 25^{\circ}\text{C}$ $T_{vj} = 125^{\circ}\text{C}$	$t_{d\text{ on}}$	0,70 0,80		μs μs
Anstiegszeit (induktive Last) rise time (inductive load)	$I_C = 500\text{ A}$, $V_{CE} = 3600\text{ V}$ $V_{GE} = \pm 15\text{ V}$ $R_{G\text{on}} = 1,5\ \Omega$	$T_{vj} = 25^{\circ}\text{C}$ $T_{vj} = 125^{\circ}\text{C}$	t_r	0,33 0,40		μs μs
Abschaltverzögerungszeit (ind. Last) turn-off delay time (inductive load)	$I_C = 500\text{ A}$, $V_{CE} = 3600\text{ V}$ $V_{GE} = \pm 15\text{ V}$ $R_{G\text{off}} = 10\ \Omega$	$T_{vj} = 25^{\circ}\text{C}$ $T_{vj} = 125^{\circ}\text{C}$	$t_{d\text{ off}}$	7,30 7,60		μs μs
Fallzeit (induktive Last) fall time (inductive load)	$I_C = 500\text{ A}$, $V_{CE} = 3600\text{ V}$ $V_{GE} = \pm 15\text{ V}$ $R_{G\text{off}} = 10\ \Omega$	$T_{vj} = 25^{\circ}\text{C}$ $T_{vj} = 125^{\circ}\text{C}$	t_f	0,40 0,50		μs μs
Einschaltverlustenergie pro Puls turn-on energy loss per pulse	$I_C = 500\text{ A}$, $V_{CE} = 3600\text{ V}$, $L_S = 280\text{ nH}$ $V_{GE} = \pm 15\text{ V}$, $di/dt = 2000\text{ A}/\mu\text{s}$ ($T_{vj}=125^{\circ}\text{C}$) $R_{G\text{on}} = 1,5\ \Omega$	$T_{vj} = 25^{\circ}\text{C}$ $T_{vj} = 125^{\circ}\text{C}$	E_{on}	2800 4300		mJ mJ
Abschaltverlustenergie pro Puls turn-off energy loss per pulse	$I_C = 500\text{ A}$, $V_{CE} = 3600\text{ V}$, $L_S = 280\text{ nH}$ $V_{GE} = \pm 15\text{ V}$ $R_{G\text{off}} = 10\ \Omega$	$T_{vj} = 25^{\circ}\text{C}$ $T_{vj} = 125^{\circ}\text{C}$	E_{off}	2400 2800		mJ mJ
Kurzschlussverhalten SC data	$V_{GE} \leq 15\text{ V}$, $V_{CC} = 4500\text{ V}$ $V_{CE\text{ max}} = V_{CES} - L_{S\text{CE}} \cdot di/dt$ $t_p \leq 10\ \mu\text{s}$, $T_{vj} = 125^{\circ}\text{C}$		I_{SC}	3000		A
Innerer Wärmewiderstand thermal resistance, junction to case	pro IGBT / per IGBT		R_{thJC}		13,0	K/kW
Übergangs-Wärmewiderstand thermal resistance, case to heatsink	pro IGBT / per IGBT $\lambda_{\text{Paste}} = 1\text{ W}/(\text{m}\cdot\text{K})$ / $\lambda_{\text{grease}} = 1\text{ W}/(\text{m}\cdot\text{K})$		R_{thCH}	13,0		K/kW

prepared by: TH	date of publication: 2010-12-13
approved by: TS	revision: 2.0

Vorläufige Daten
preliminary data

Diode-Wechselrichter / diode-inverter

Höchstzulässige Werte / maximum rated values

Periodische Spitzensperrensorgung repetitive peak reverse voltage	$T_{vj} = 125^{\circ}\text{C}$ $T_{vj} = 25^{\circ}\text{C}$ $T_{vj} = -40^{\circ}\text{C}$	V_{RRM}	6500 6500 6000	V
Dauergleichstrom DC forward current		I_F	500	A
Periodischer Spitzenstrom repetitive peak forward current	$t_p = 1 \text{ ms}$	I_{FRM}	1000	A
Grenzlastintegral I^2t - value	$V_R = 0 \text{ V}$, $t_p = 10 \text{ ms}$, $T_{vj} = 125^{\circ}\text{C}$	I^2t	210	kA^2s
Spitzenverlustleistung maximum power dissipation	$T_{vj} = 125^{\circ}\text{C}$	P_{ROM}	2000	kW
Mindesteinschaltdauer minimum turn-on time		$t_{on \text{ min}}$	10,0	μs

Charakteristische Werte / characteristic values

			min.	typ.	max.	
Durchlassspannung forward voltage	$I_F = 500 \text{ A}$, $V_{GE} = 0 \text{ V}$ $I_F = 500 \text{ A}$, $V_{GE} = 0 \text{ V}$	$T_{vj} = 25^{\circ}\text{C}$ $T_{vj} = 125^{\circ}\text{C}$	V_F	3,00 2,95	3,50	V V
Rückstromspitze peak reverse recovery current	$I_F = 500 \text{ A}$, $-di_F/dt = 2000 \text{ A}/\mu\text{s}$ ($T_{vj}=125^{\circ}\text{C}$) $V_R = 3600 \text{ V}$ $V_{GE} = -15 \text{ V}$	$T_{vj} = 25^{\circ}\text{C}$ $T_{vj} = 125^{\circ}\text{C}$	I_{RM}	730 800		A A
Sperrverzögerungsladung recovered charge	$I_F = 500 \text{ A}$, $-di_F/dt = 2000 \text{ A}/\mu\text{s}$ ($T_{vj}=125^{\circ}\text{C}$) $V_R = 3600 \text{ V}$ $V_{GE} = -15 \text{ V}$	$T_{vj} = 25^{\circ}\text{C}$ $T_{vj} = 125^{\circ}\text{C}$	Q_r	570 1050		μC μC
Abschaltenergie pro Puls reverse recovery energy	$I_F = 500 \text{ A}$, $-di_F/dt = 2000 \text{ A}/\mu\text{s}$ ($T_{vj}=125^{\circ}\text{C}$) $V_R = 3600 \text{ V}$ $V_{GE} = -15 \text{ V}$	$T_{vj} = 25^{\circ}\text{C}$ $T_{vj} = 125^{\circ}\text{C}$	E_{rec}	930 2000		mJ mJ
Innerer Wärmewiderstand thermal resistance, junction to case	pro Diode / per diode		R_{thJC}		28,0	K/kW
Übergangs-Wärmewiderstand thermal resistance, case to heatsink	pro Diode / per diode $\lambda_{\text{Paste}} = 1 \text{ W}/(\text{m}\cdot\text{K})$ / $\lambda_{\text{grease}} = 1 \text{ W}/(\text{m}\cdot\text{K})$		R_{thCH}	21,0		K/kW

prepared by: TH	date of publication: 2010-12-13
approved by: TS	revision: 2.0

Technische Information / technical information

IGBT-Module
IGBT-modules

FZ500R65KE3



Vorläufige Daten preliminary data

Modul / module

Isolations-Prüfspannung insulation test voltage	RMS, f = 50 Hz, t = 1 min.	V _{ISOL}	10,2		kV
Teilentladungs Aussetzspannung partial discharge extinction voltage	RMS, f = 50 Hz, Q _{PD} typ 10 pC (acc. to IEC 1287)	V _{ISOL}	5,1		kV
Kollektor-Emitter-Gleichsperrspannung DC stability	T _{vj} = 25°C, 100 fit	V _{CE D}	3800		V
Material Modulgrundplatte material of module baseplate			AlSiC		
Material für innere Isolation material for internal insulation			AlN		
Kriechstrecke creepage distance	Kontakt - Kühlkörper / terminal to heatsink Kontakt - Kontakt / terminal to terminal		56,0 56,0		mm
Luftstrecke clearance distance	Kontakt - Kühlkörper / terminal to heatsink Kontakt - Kontakt / terminal to terminal		26,0 26,0		mm
Vergleichszahl der Kriechwegbildung comparative tracking index		CTI	> 600		
			min.	typ.	max.
Modulinduktivität stray inductance module		L _{sCE}		20	nH
Modulleitungswiderstand, Anschlüsse - Chip module lead resistance, terminals - chip	T _c = 25°C, pro Schalter / per switch	R _{CC'+EE'} R _{AA'+CC'}		0,18 0,18	mΩ
Höchstzulässige Sperschichttemperatur maximum junction temperature	Wechselrichter, Brems-Chopper / Inverter, Brake-Chopper	T _{vj max}			150 °C
Temperatur im Schaltbetrieb temperature under switching conditions	Wechselrichter, Brems-Chopper / Inverter, Brake-Chopper	T _{vj op}	-40		125 °C
Lagertemperatur storage temperature		T _{stg}	-40		125 °C
Anzugsdrehmoment f. mech. Befestigung mounting torque	Schraube M6 - Montage gem. gültiger Applikation Note screw M6 - mounting according to valid application note	M	4,25	-	5,75 Nm
Anzugsdrehmoment f. elektr. Anschlüsse terminal connection torque	Schraube M4 - Montage gem. gültiger Applikation Note screw M4 - mounting according to valid application note Schraube M8 - Montage gem. gültiger Applikation Note screw M8 - mounting according to valid application note	M	1,8 8,0	-	2,1 10 Nm
Gewicht weight		G		1000	g

prepared by: TH	date of publication: 2010-12-13
approved by: TS	revision: 2.0

Vorläufige Daten
preliminary data

Ausgangskennlinie IGBT-Wechselr. (typisch)
output characteristic IGBT-inverter (typical)
 $I_c = f(V_{CE})$
 $V_{GE} = 15\text{ V}$

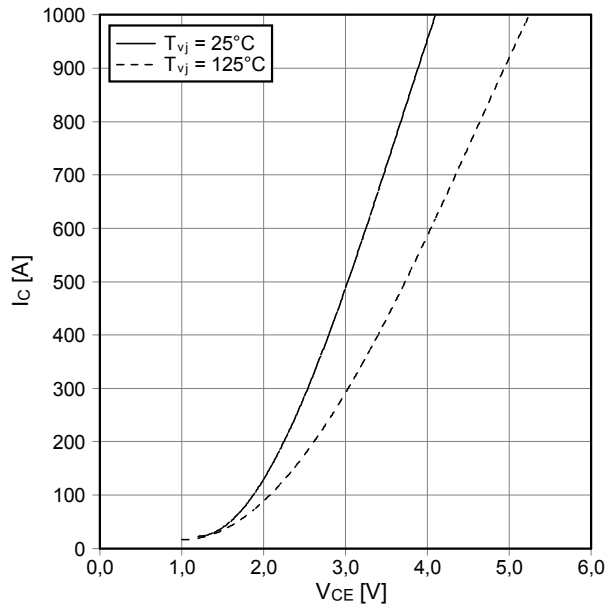

Ausgangskennlinienfeld IGBT-Wechselr. (typisch)
output characteristic IGBT-inverter (typical)
 $I_c = f(V_{CE})$
 $T_{vj} = 125^\circ\text{C}$

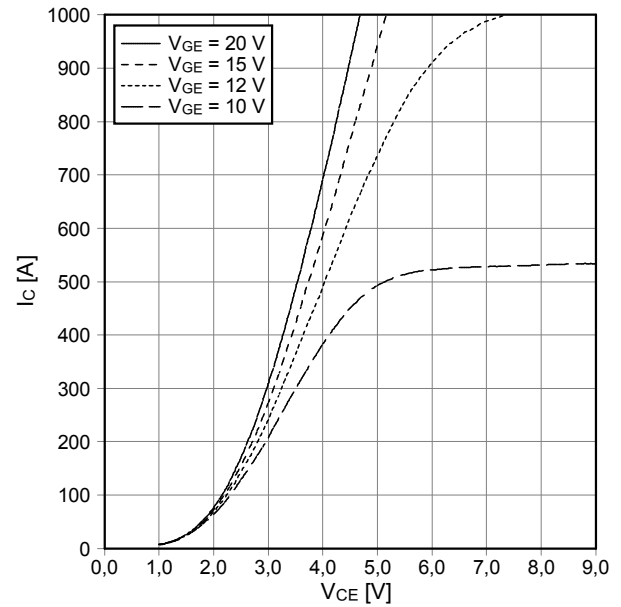

Übertragungscharakteristik IGBT-Wechselr. (typisch)
transfer characteristic IGBT-inverter (typical)
 $I_c = f(V_{GE})$
 $V_{CE} = 20\text{ V}$

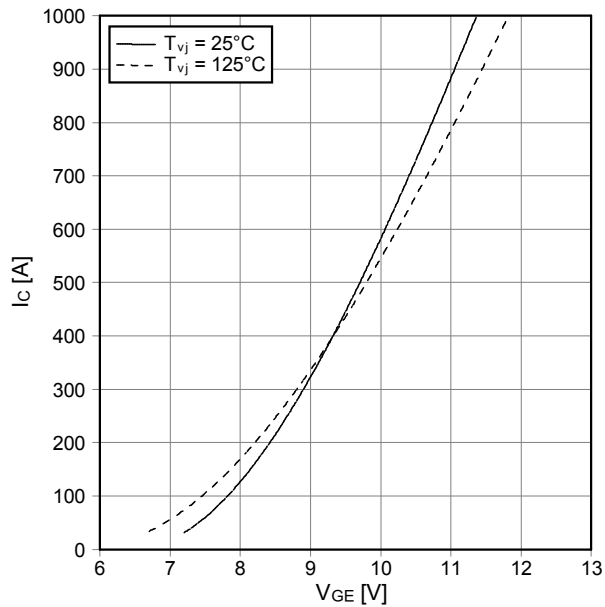

Schaltverluste IGBT-Wechselr. (typisch)
switching losses IGBT-inverter (typical)
 $E_{on} = f(I_c)$, $E_{off} = f(I_c)$
 $V_{GE} = \pm 15\text{ V}$, $R_{Gon} = 1.5\ \Omega$, $R_{Goff} = 10\ \Omega$, $V_{CE} = 3600\text{ V}$

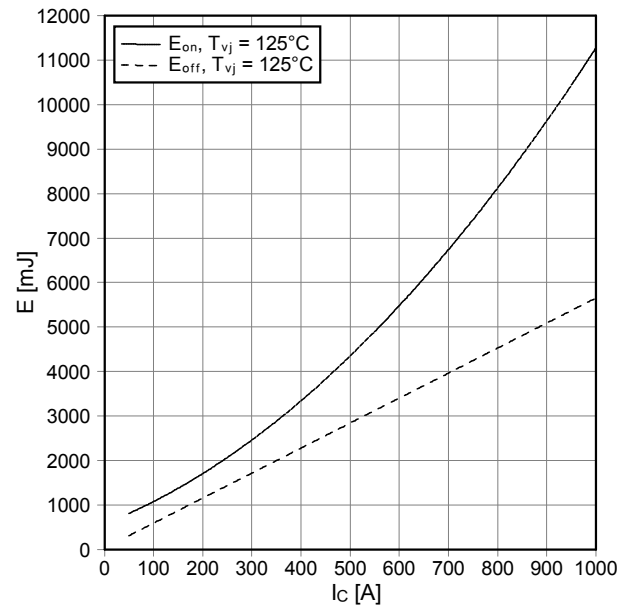

prepared by: TH	date of publication: 2010-12-13
approved by: TS	revision: 2.0

Vorläufige Daten
preliminary data

Schaltverluste IGBT-Wechselr. (typisch)
switching losses IGBT-Inverter (typical)
 $E_{on} = f(R_G)$, $E_{off} = f(R_G)$
 $V_{GE} = \pm 15\text{ V}$, $I_C = 500\text{ A}$, $V_{CE} = 3600\text{ V}$

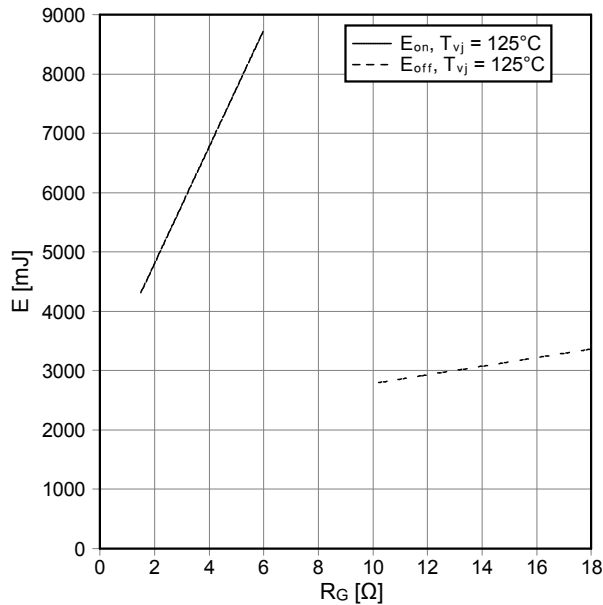

Transienter Wärmewiderstand IGBT-Wechselr.
transient thermal impedance IGBT-inverter
 $Z_{thJC} = f(t)$

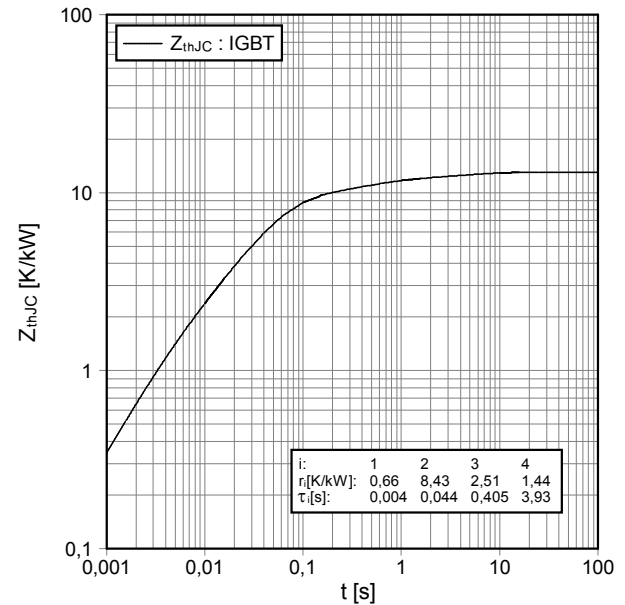

Sicherer Rückwärts-Arbeitsbereich IGBT-Wr. (RBSOA)
reverse bias safe operating area IGBT-inv. (RBSOA)
 $I_C = f(V_{CE})$
 $V_{GE} = \pm 15\text{ V}$, $R_{Goff} = 10\ \Omega$, $T_{vj} = 125^\circ\text{C}$

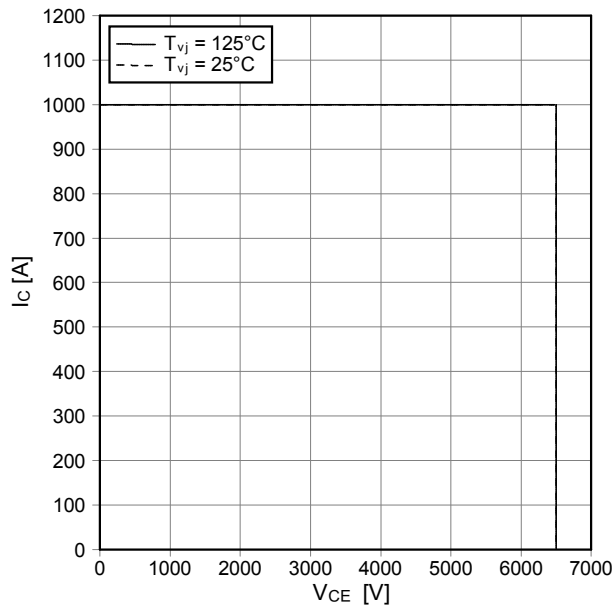

Durchlasskennlinie der Diode-Wechselr. (typisch)
forward characteristic of diode-inverter (typical)
 $I_F = f(V_F)$

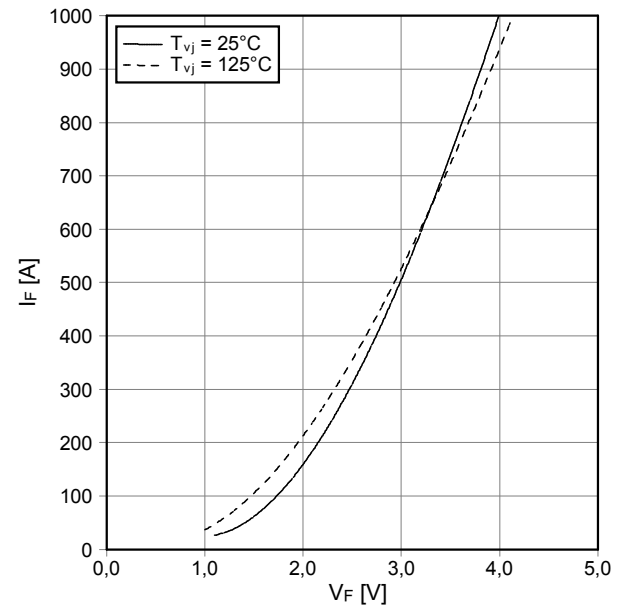

prepared by: TH	date of publication: 2010-12-13
approved by: TS	revision: 2.0

Vorläufige Daten
preliminary data

Schaltverluste Diode-Wechselr. (typisch)
switching losses diode-inverter (typical)

$E_{rec} = f(I_F)$
 $R_{Gon} = 1.5 \Omega, V_{CE} = 3600 V$

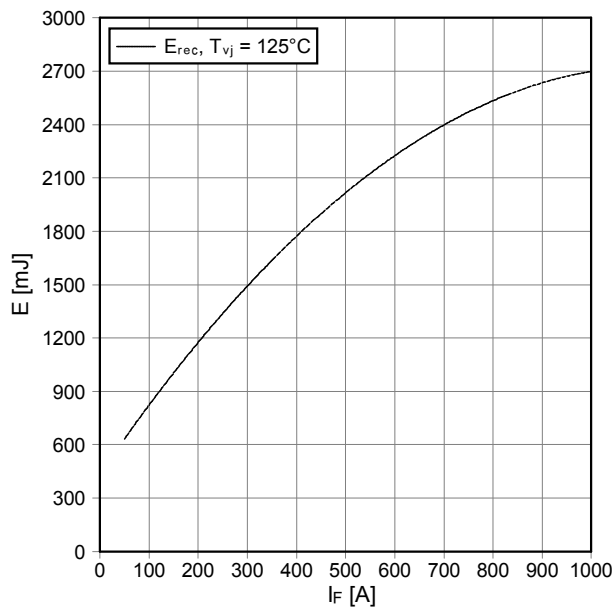

Schaltverluste Diode-Wechselr. (typisch)
switching losses diode-inverter (typical)

$E_{rec} = f(R_G)$
 $I_F = 500 A, V_{CE} = 3600 V$

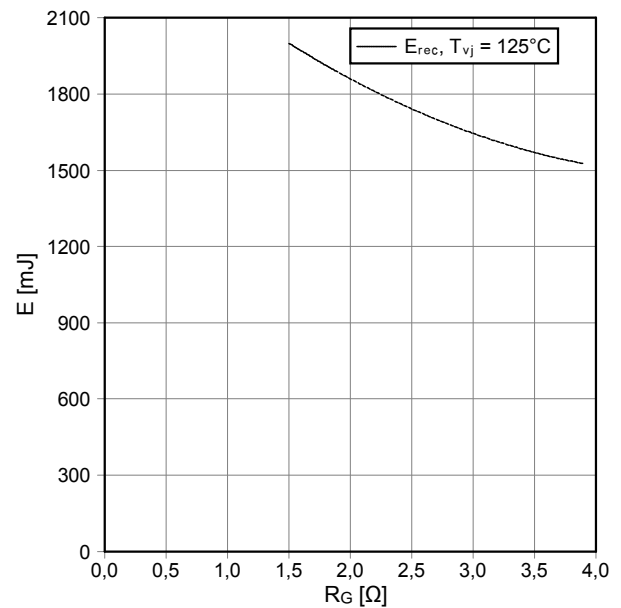

Transienter Wärmewiderstand Diode-Wechselr.
transient thermal impedance diode-inverter

$Z_{thJC} = f(t)$

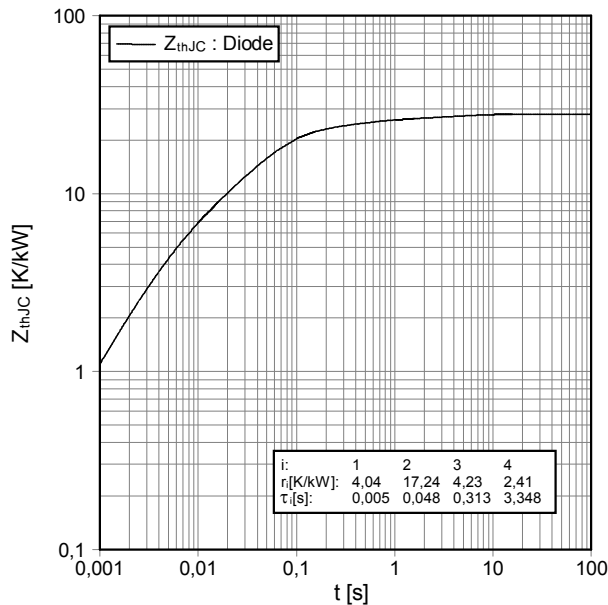

Sicherer Arbeitsbereich Diode-Wechselr. (SOA)
safe operation area diode-inverter (SOA)

$I_R = f(V_R)$
 $T_{vj} = 125^\circ C$

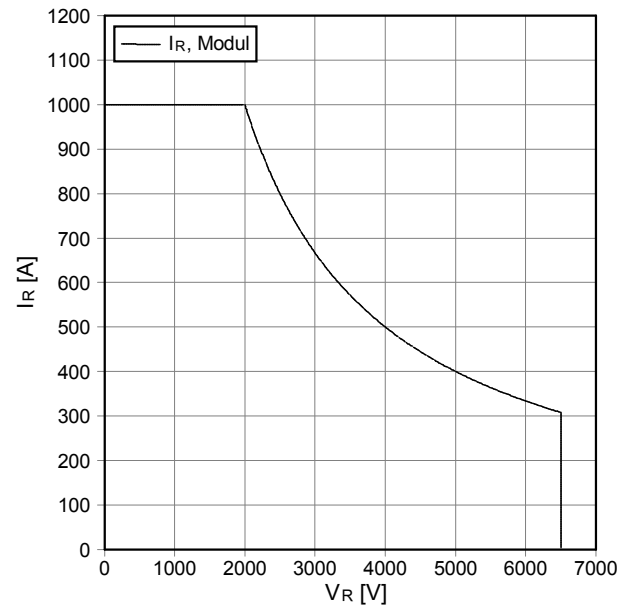

prepared by: TH	date of publication: 2010-12-13
approved by: TS	revision: 2.0

Schaltplan / circuit diagram

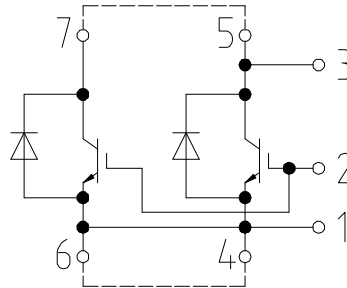

Gehäuseabmessungen / package outlines

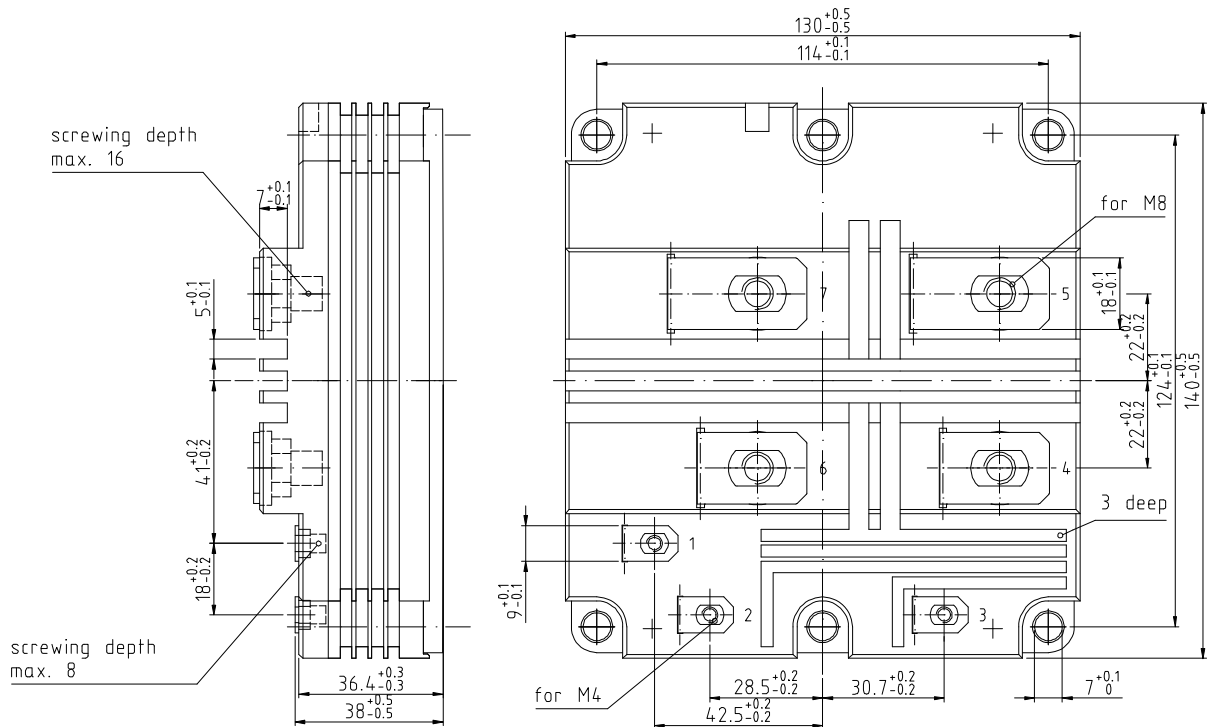
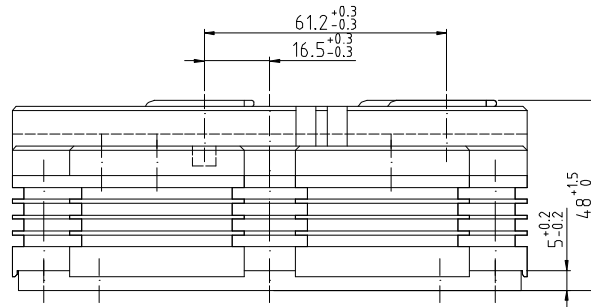

prepared by: TH	date of publication: 2010-12-13
approved by: TS	revision: 2.0



Nutzungsbedingungen

Die in diesem Produktdatenblatt enthaltenen Daten sind ausschließlich für technisch geschultes Fachpersonal bestimmt. Die Beurteilung der Eignung dieses Produktes für Ihre Anwendung sowie die Beurteilung der Vollständigkeit der bereitgestellten Produktdaten für diese Anwendung obliegt Ihnen bzw. Ihren technischen Abteilungen.

In diesem Produktdatenblatt werden diejenigen Merkmale beschrieben, für die wir eine liefervertragliche Gewährleistung übernehmen. Eine solche Gewährleistung richtet sich ausschließlich nach Maßgabe der im jeweiligen Liefervertrag enthaltenen Bestimmungen. Garantien jeglicher Art werden für das Produkt und dessen Eigenschaften keinesfalls übernommen.

Sollten Sie von uns Produktinformationen benötigen, die über den Inhalt dieses Produktdatenblatts hinausgehen und insbesondere eine spezifische Verwendung und den Einsatz dieses Produktes betreffen, setzen Sie sich bitte mit dem für Sie zuständigen Vertriebsbüro in Verbindung (siehe www.infineon.com, Vertrieb&Kontakt). Für Interessenten halten wir Application Notes bereit.

Aufgrund der technischen Anforderungen könnte unser Produkt gesundheitsgefährdende Substanzen enthalten. Bei Rückfragen zu den in diesem Produkt jeweils enthaltenen Substanzen setzen Sie sich bitte ebenfalls mit dem für Sie zuständigen Vertriebsbüro in Verbindung.

Sollten Sie beabsichtigen, das Produkt in Anwendungen der Luftfahrt, in gesundheits- oder lebensgefährdenden oder lebenserhaltenden Anwendungsbereichen einzusetzen, bitten wir um Mitteilung. Wir weisen darauf hin, dass wir für diese Fälle

- die gemeinsame Durchführung eines Risiko- und Qualitätsassessments;
- den Abschluss von speziellen Qualitätssicherungsvereinbarungen;
- die gemeinsame Einführung von Maßnahmen zu einer laufenden Produktbeobachtung dringend empfehlen und gegebenenfalls die Belieferung von der Umsetzung solcher Maßnahmen abhängig machen.

Soweit erforderlich, bitten wir Sie, entsprechende Hinweise an Ihre Kunden zu geben.

Inhaltliche Änderungen dieses Produktdatenblatts bleiben vorbehalten.

Terms & Conditions of usage

The data contained in this product data sheet is exclusively intended for technically trained staff. You and your technical departments will have to evaluate the suitability of the product for the intended application and the completeness of the product data with respect to such application.

This product data sheet is describing the characteristics of this product for which a warranty is granted. Any such warranty is granted exclusively pursuant the terms and conditions of the supply agreement. There will be no guarantee of any kind for the product and its characteristics.

Should you require product information in excess of the data given in this product data sheet or which concerns the specific application of our product, please contact the sales office, which is responsible for you (see www.infineon.com, sales&contact). For those that are specifically interested we may provide application notes.

Due to technical requirements our product may contain dangerous substances. For information on the types in question please contact the sales office, which is responsible for you.

Should you intend to use the Product in aviation applications, in health or live endangering or life support applications, please notify. Please note, that for any such applications we urgently recommend

- to perform joint Risk and Quality Assessments;
- the conclusion of Quality Agreements;
- to establish joint measures of an ongoing product survey, and that we may make delivery depended on the realization of any such measures.

If and to the extent necessary, please forward equivalent notices to your customers.

Changes of this product data sheet are reserved.

prepared by: TH	date of publication: 2010-12-13
approved by: TS	revision: 2.0