

KST2222A

NPN Epitaxial Silicon Transistor

General Purpose Transistor

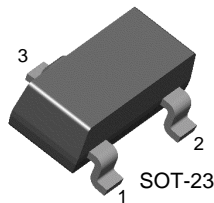

1. Base 2. Emitter 3. Collector

Marking

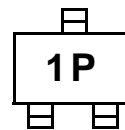

Absolute Maximum Ratings $T_a = 25^\circ\text{C}$ unless otherwise noted

Symbol	Parameter	Value	Units
V_{CBO}	Collector-Base Voltage	75	V
V_{CEO}	Collector-Emitter Voltage	40	V
V_{EBO}	Emitter-Base Voltage	6	V
I_C	Collector Current	600	mA
P_C	Collector Power Dissipation	350	mW
T_{STG}	Storage Temperature Range	-55 ~ 150	$^\circ\text{C}$

Electrical Characteristics $T_a = 25^\circ\text{C}$ unless otherwise noted

Symbol	Parameter	Test Condition	Min.	Max.	Units
BV_{CBO}	Collector-Base Breakdown Voltage	$I_C = 10\mu\text{A}, I_E = 0$	75		V
BV_{CEO}	Collector-Emitter Breakdown Voltage	$I_C = 10\text{mA}, I_B = 0$	40		V
BV_{EBO}	Emitter-Base Breakdown Voltage	$I_E = 10\mu\text{A}, I_C = 0$	6		V
I_{CBO}	Collector Cut-off Current	$V_{CB} = 60\text{V}, I_E = 0$		0.01	μA
h_{FE}	DC Current Gain *	$V_{CE} = 10\text{V}, I_C = 0.1\text{mA}$ $V_{CE} = 10\text{V}, I_C = 1\text{mA}$ $V_{CE} = 10\text{V}, I_C = 10\text{mA}$ $V_{CE} = 10\text{V}, I_C = 150\text{mA}$ $V_{CE} = 10\text{V}, I_C = 500\text{mA}$	35 50 75 100 40	300	
$V_{CE}(\text{sat})$	Collector-Emitter Saturation Voltage *	$I_C = 150\text{mA}, I_B = 15\text{mA}$ $I_C = 500\text{mA}, I_B = 50\text{mA}$		0.3 1.0	V V
$V_{BE}(\text{sat})$	Base-Emitter Saturation Voltage *	$I_C = 150\text{mA}, I_B = 15\text{mA}$ $I_C = 500\text{mA}, I_B = 50\text{mA}$	0.6	1.2 2.0	V V
f_T	Current Gain Bandwidth Product	$I_C = 20\text{mA}, V_{CE} = 20\text{V}, f = 100\text{MHz}$	300		MHz
C_{ob}	Output Capacitance	$V_{CB} = 10\text{V}, I_E = 0, f = 1\text{MHz}$		8	pF
NF	Noise Figure	$I_C = 100\mu\text{A}, V_{CE} = 10\text{V}$ $R_S = 1\text{K}\Omega, f = 1\text{MHz}$		4	dB
t_{ON}	Turn On Time	$V_{CC} = 30\text{V}, I_C = 150\text{mA}$ $V_{BE} = 0.5\text{V}, I_{B1} = 15\text{mA}$		35	ns
t_{OFF}	Turn Off Time	$V_{CC} = 30\text{V}, I_C = 150\text{mA},$ $I_{B1} = I_{B2} = 15\text{mA}$		285	ns

* Pulse Test: Pulse Width \leq 300 μs , Duty Cycle \leq 2%

Typical Performance Characteristics

Figure 1. DC Current Gain

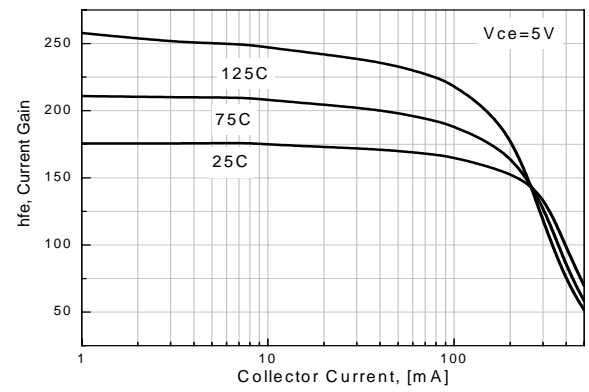

Figure 2. Collector-Emitter Saturation Voltage

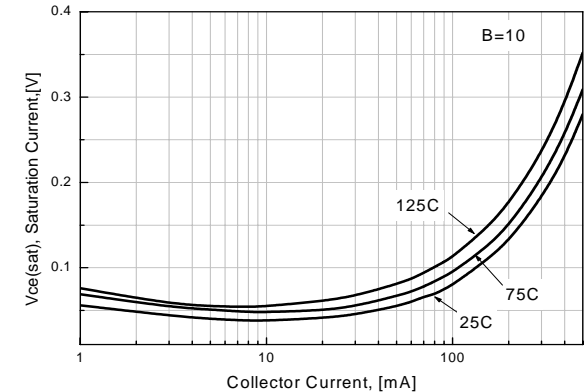

Figure 3. Base-Emitter Saturation Voltage

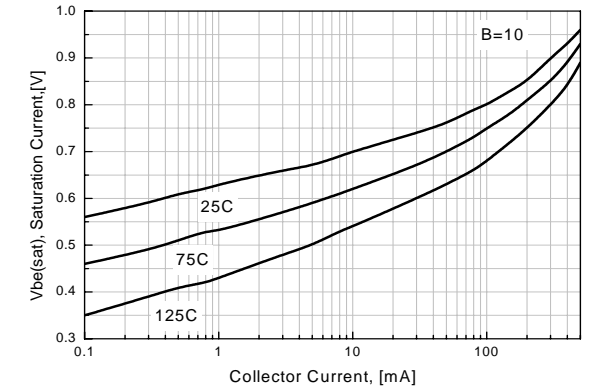

Figure 4. Collector - Base Leakage Current

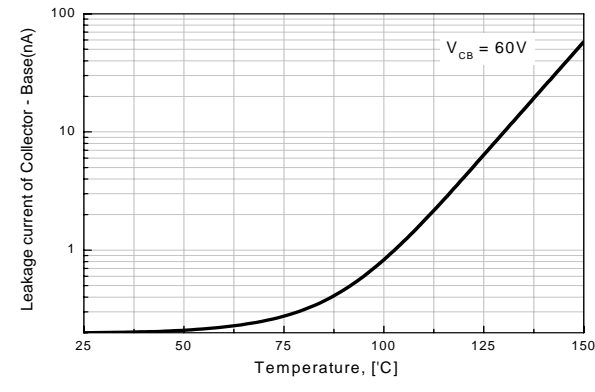

Figure 5. Output Capacitance

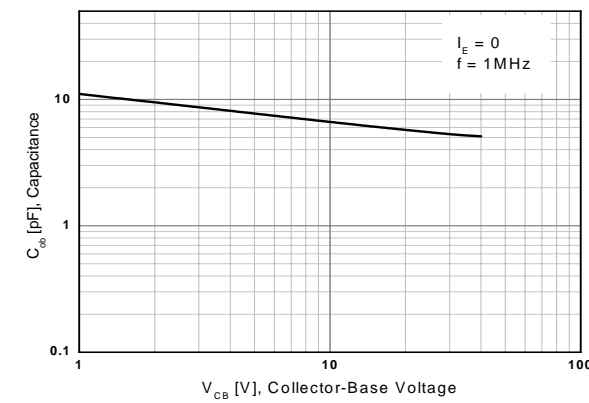
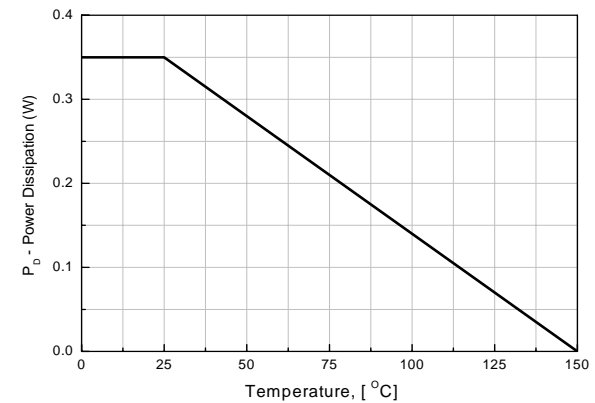
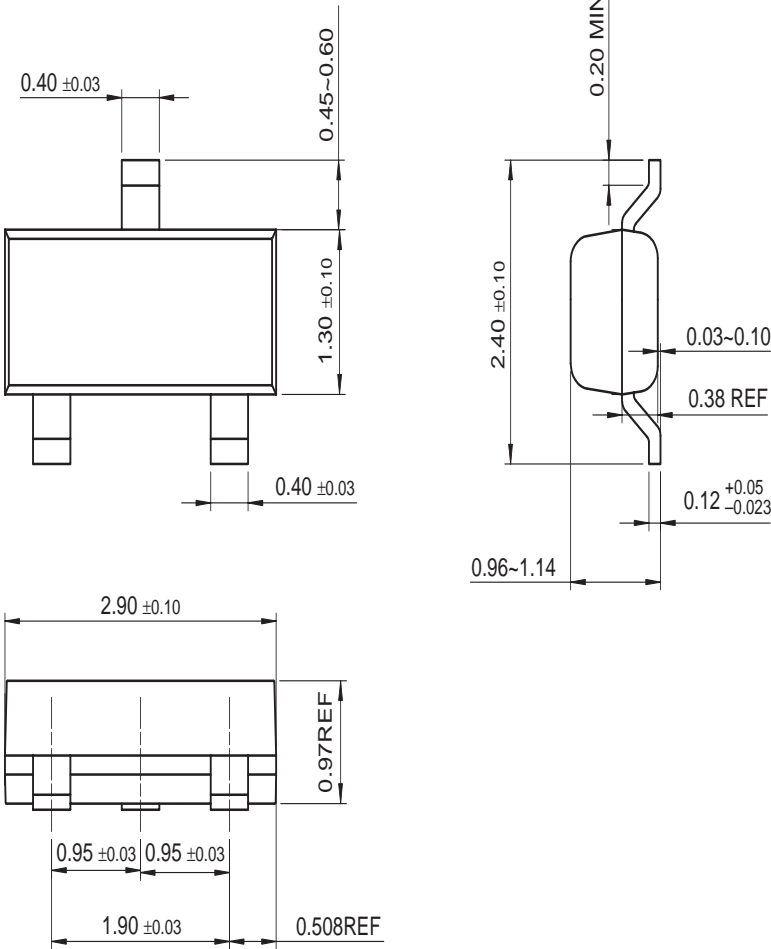

Figure 6. Power Dissipation vs Ambient Temperature



Mechanical Dimensions

SOT-23



Dimensions in Millimeters

TRADEMARKS

The following are registered and unregistered trademarks Fairchild Semiconductor owns or is authorized to use and is not intended to be an exhaustive list of all such trademarks.

ACE ^x TM	FAST [®]	ISOPLANAR TM	PowerEdge TM	SuperFET TM
ActiveArray TM	FAST ^r TM	LittleFET TM	PowerSaver TM	SuperSOT TM -3
Bottomless TM	FPS TM	MICROCOUPLER TM	PowerTrench [®]	SuperSOT TM -6
Build it Now TM	FRFET TM	MicroFET TM	QFET [®]	SuperSOT TM -8
CoolFET TM	GlobalOptoisolator TM	MicroPak TM	QS TM	SyncFET TM
CROSSVOLT TM	GTO TM	MICROWIRE TM	QT Optoelectronics TM	TCM TM
DOMET TM	HiSeC TM	MSX TM	Quiet Series TM	TinyLogic [®]
EcoSPARK TM	I ² C TM	MSXPro TM	RapidConfigure TM	TINYOPTO TM
E ² CMOS TM	<i>i-Lo</i> TM	OCX TM	RapidConnect TM	TruTranslation TM
EnSigna TM	ImpliedDisconnect TM	OCXPro TM	μSerDes TM	UHC TM
FACT TM	IntelliMAX TM	OPTOLOGIC [®]	ScalarPump TM	UltraFET [®]
FACT Quiet Series TM		OPTOPLANAR TM	SILENT SWITCHER [®]	UniFET TM
Across the board. Around the world. TM		PACMAN TM	SMART START TM	VCX TM
The Power Franchise [®]		POPT TM	SPM TM	Wire TM
Programmable Active Droop TM		Power247 TM	Stealth TM	

DISCLAIMER

FAIRCHILD SEMICONDUCTOR RESERVES THE RIGHT TO MAKE CHANGES WITHOUT FURTHER NOTICE TO ANY PRODUCTS HEREIN TO IMPROVE RELIABILITY, FUNCTION OR DESIGN. FAIRCHILD DOES NOT ASSUME ANY LIABILITY ARISING OUT OF THE APPLICATION OR USE OF ANY PRODUCT OR CIRCUIT DESCRIBED HEREIN; NEITHER DOES IT CONVEY ANY LICENSE UNDER ITS PATENT RIGHTS, NOR THE RIGHTS OF OTHERS. THESE SPECIFICATIONS DO NOT EXPAND THE TERMS OF FAIRCHILD'S WORLDWIDE TERMS AND CONDITIONS SPECIFICALLY THE WARRANTY THEREIN, WHICH COVERS THESE PRODUCTS.

LIFE SUPPORT POLICY

FAIRCHILD'S PRODUCTS ARE NOT AUTHORIZED FOR USE AS CRITICAL COMPONENTS IN LIFE SUPPORT DEVICES OR SYSTEMS WITHOUT THE EXPRESS WRITTEN APPROVAL OF FAIRCHILD SEMICONDUCTOR CORPORATION.

As used herein:

1. Life support devices or systems are devices or systems which, (a) are intended for surgical implant into the body, or (b) support or sustain life, or (c) whose failure to perform when properly used in accordance with instructions for use provided in the labeling, can be reasonably expected to result in significant injury to the user.
2. A critical component is any component of a life support device or system whose failure to perform can be reasonably expected to cause the failure of the life support device or system, or to affect its safety or effectiveness.

PRODUCT STATUS DEFINITIONS

Definition of Terms

Datasheet Identification	Product Status	Definition
Advance Information	Formative or In Design	This datasheet contains the design specifications for product development. Specifications may change in any manner without notice.
Preliminary	First Production	This datasheet contains preliminary data, and supplementary data will be published at a later date. Fairchild Semiconductor reserves the right to make changes at any time without notice in order to improve design.
No Identification Needed	Full Production	This datasheet contains final specifications. Fairchild Semiconductor reserves the right to make changes at any time without notice in order to improve design.
Obsolete	Not In Production	This datasheet contains specifications on a product that has been discontinued by Fairchild semiconductor. The datasheet is printed for reference information only.

Rev. 119