



# FGA60N60UFD

## 600V, 60A Field Stop IGBT

### Features

- High current capability
- Low saturation voltage:  $V_{CE(sat)} = 1.9V @ I_C = 60A$
- High input impedance
- Fast switching
- RoHS compliant

### Applications

- Induction Heating, UPS, SMPS, PFC



### General Description

Using Novel Field Stop IGBT Technology, Fairchild's new series of Field Stop IGBTs offer the optimum performance for Induction Heating, UPS, SMPS and PFC applications where low conduction and switching losses are essential.

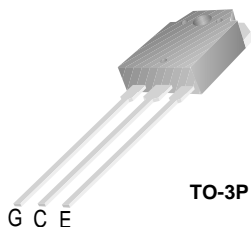

TO-3P

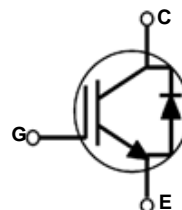

### Absolute Maximum Ratings

Symbol	Description	Ratings	Units
$V_{CES}$	Collector to Emitter Voltage	600	V
$V_{GES}$	Gate to Emitter Voltage	$\pm 20$	V
$I_C$	Collector Current @ $T_C = 25^\circ C$	120	A
	Collector Current @ $T_C = 100^\circ C$	60	A
$I_{CM(1)}$	Pulsed Collector Current @ $T_C = 25^\circ C$	180	A
$P_D$	Maximum Power Dissipation @ $T_C = 25^\circ C$	298	W
	Maximum Power Dissipation @ $T_C = 100^\circ C$	119	W
$T_J$	Operating Junction Temperature	-55 to +150	$^\circ C$
$T_{stg}$	Storage Temperature Range	-55 to +150	$^\circ C$
$T_L$	Maximum Lead Temp. for soldering Purposes, 1/8" from case for 5 seconds	300	$^\circ C$

**Notes:**

1: Repetitive test, Pulse width limited by max. junction temperature

### Thermal Characteristics

Symbol	Parameter	Typ.	Max.	Units
$R_{\theta JC}(IGBT)$	Thermal Resistance, Junction to Case	-	0.33	$^\circ C/W$
$R_{\theta JC}(Diode)$	Thermal Resistance, Junction to Case	-	1.1	$^\circ C/W$
$R_{\theta JA}$	Thermal Resistance, Junction to Ambient	-	40	$^\circ C/W$

### Package Marking and Ordering Information

Device Marking	Device	Package	Packaging Type	Qty per Tube	Max Qty per Box
FGA60N60UFD	FGA60N60UFDTU	TO-3PN	Tube	30ea	-

### Electrical Characteristics of the IGBT T<sub>C</sub> = 25°C unless otherwise noted

Symbol	Parameter	Test Conditions	Min.	Typ.	Max.	Units
<b>Off Characteristics</b>						
BV <sub>CES</sub>	Collector to Emitter Breakdown Voltage	V <sub>GE</sub> = 0V, I <sub>C</sub> = 250μA	600	-	-	V
$\frac{\Delta BV_{CES}}{\Delta T_J}$	Temperature Coefficient of Breakdown Voltage	V <sub>GE</sub> = 0V, I <sub>C</sub> = 250μA	-	0.67	-	V/°C
I <sub>CES</sub>	Collector Cut-Off Current	V <sub>CE</sub> = V <sub>CES</sub> , V <sub>GE</sub> = 0V	-	-	250	μA
I <sub>GES</sub>	G-E Leakage Current	V <sub>GE</sub> = V <sub>GES</sub> , V <sub>CE</sub> = 0V	-	-	±400	nA
<b>On Characteristics</b>						
V <sub>GE(th)</sub>	G-E Threshold Voltage	I <sub>C</sub> = 250μA, V <sub>CE</sub> = V <sub>GE</sub>	4.0	5.0	6.5	V
V <sub>CE(sat)</sub>	Collector to Emitter Saturation Voltage	I <sub>C</sub> = 60A, V <sub>GE</sub> = 15V	-	1.9	2.4	V
		I <sub>C</sub> = 60A, V <sub>GE</sub> = 15V, T <sub>C</sub> = 125°C	-	2.1	-	V
<b>Dynamic Characteristics</b>						
C <sub>ies</sub>	Input Capacitance	V <sub>CE</sub> = 30V, V <sub>GE</sub> = 0V, f = 1MHz	-	2855	-	pF
C <sub>oes</sub>	Output Capacitance		-	325	-	pF
C <sub>res</sub>	Reverse Transfer Capacitance		-	110	-	pF
<b>Switching Characteristics</b>						
t <sub>d(on)</sub>	Turn-On Delay Time	V <sub>CC</sub> = 400V, I <sub>C</sub> = 60A, R <sub>G</sub> = 5Ω, V <sub>GE</sub> = 15V, Inductive Load, T <sub>C</sub> = 25°C	-	23	-	ns
t <sub>r</sub>	Rise Time		-	58	-	ns
t <sub>d(off)</sub>	Turn-Off Delay Time		-	130	-	ns
t <sub>f</sub>	Fall Time		-	40	80	ns
E <sub>on</sub>	Turn-On Switching Loss		-	1.81	-	mJ
E <sub>off</sub>	Turn-Off Switching Loss		-	0.81	-	mJ
E <sub>ts</sub>	Total Switching Loss		-	2.62	-	mJ
t <sub>d(on)</sub>	Turn-On Delay Time	V <sub>CC</sub> = 400V, I <sub>C</sub> = 60A, R <sub>G</sub> = 5Ω, V <sub>GE</sub> = 15V, Inductive Load, T <sub>C</sub> = 125°C	-	22	-	ns
t <sub>r</sub>	Rise Time		-	61	-	ns
t <sub>d(off)</sub>	Turn-Off Delay Time		-	141	-	ns
t <sub>f</sub>	Fall Time		-	63	-	ns
E <sub>on</sub>	Turn-On Switching Loss		-	1.92	-	mJ
E <sub>off</sub>	Turn-Off Switching Loss		-	1.23	-	mJ
E <sub>ts</sub>	Total Switching Loss		-	3.15	-	mJ
Q <sub>g</sub>	Total Gate Charge	V <sub>CE</sub> = 400V, I <sub>C</sub> = 60A, V <sub>GE</sub> = 15V	-	188	-	nC
Q <sub>ge</sub>	Gate to Emitter Charge		-	21	-	nC
Q <sub>gc</sub>	Gate to Collector Charge		-	97	-	nC

**Electrical Characteristics of the Diode**  $T_C = 25^\circ\text{C}$  unless otherwise noted

Symbol	Parameter	Test Conditions		Min.	Typ.	Max	Units
$V_{FM}$	Diode Forward Voltage	$I_F = 30\text{A}$	$T_C = 25^\circ\text{C}$	-	2.0	2.6	V
			$T_C = 125^\circ\text{C}$	-	1.8	-	
$t_{rr}$	Diode Reverse Recovery Time	$I_{ES} = 30\text{A}, dl_{ES}/dt = 200\text{A}/\mu\text{s}$	$T_C = 25^\circ\text{C}$	-	47	-	ns
			$T_C = 125^\circ\text{C}$	-	179	-	
$Q_{rr}$	Diode Reverse Recovery Charge	$I_{ES} = 30\text{A}, dl_{ES}/dt = 200\text{A}/\mu\text{s}$	$T_C = 25^\circ\text{C}$	-	83	-	nC
			$T_C = 125^\circ\text{C}$	-	567	-	

## Typical Performance Characteristics

Figure 1. Typical Output Characteristics

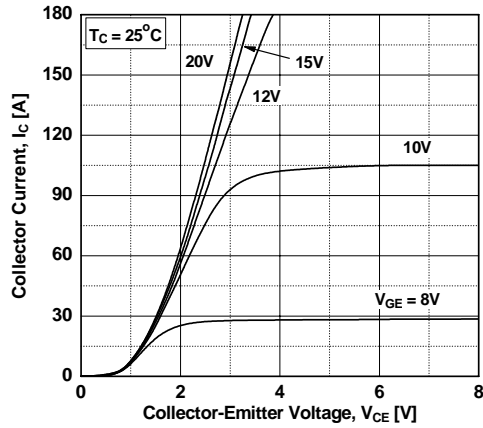

Figure 2. Typical Output Characteristics

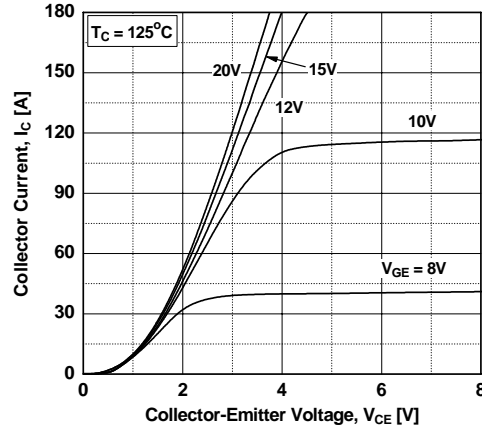

Figure 3. Typical Saturation Voltage Characteristics

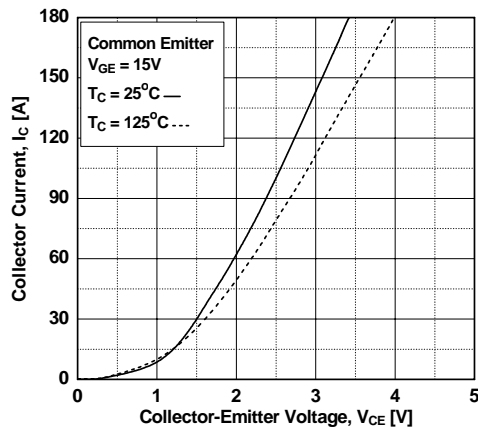

Figure 4. Transfer Characteristics

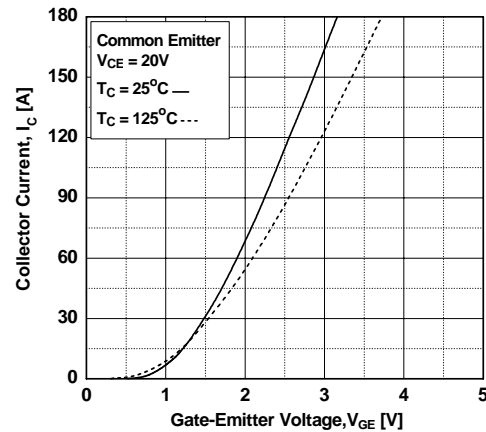

Figure 5. Saturation Voltage vs. Case Temperature at Variant Current Level

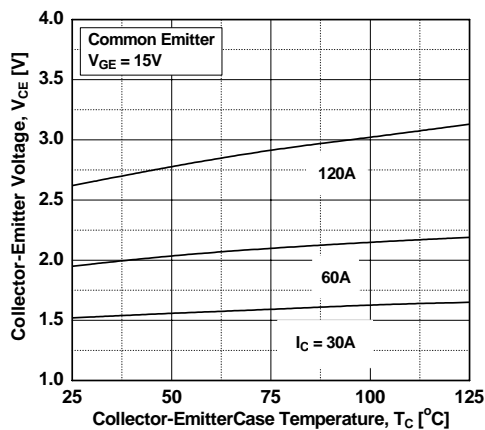
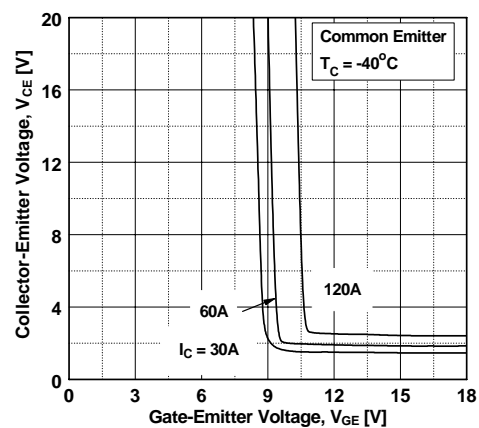

Figure 6. Saturation Voltage vs. Vge



## Typical Performance Characteristics

Figure 7. Saturation Voltage vs.  $V_{GE}$

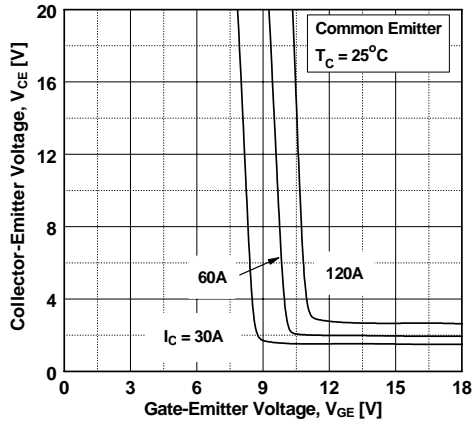

Figure 8. Saturation Voltage vs.  $V_{GE}$

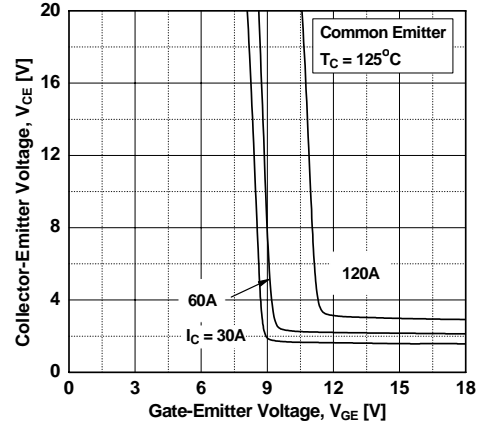

Figure 9. Capacitance Characteristics

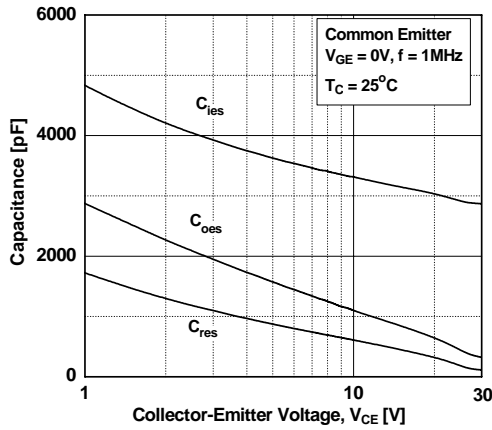

Figure 10. Gate charge Characteristics

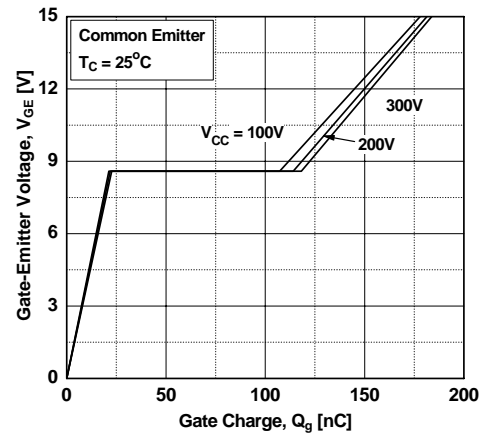

Figure 11. SOA Characteristics

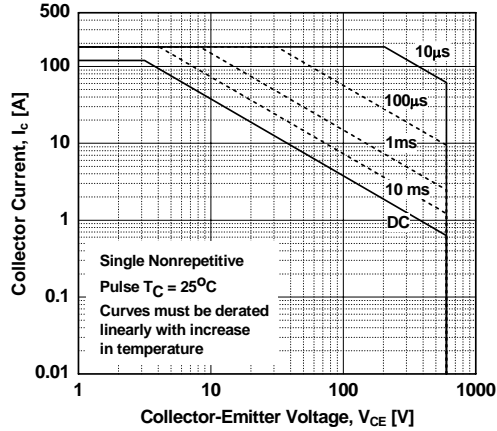
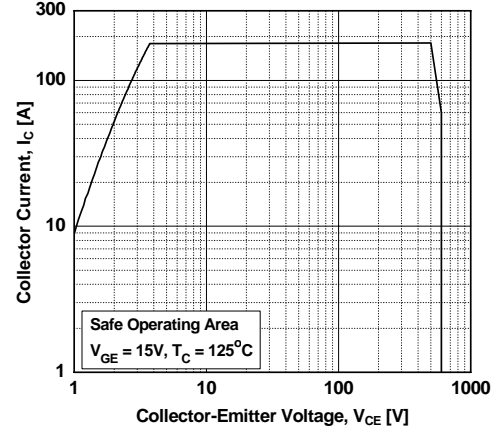
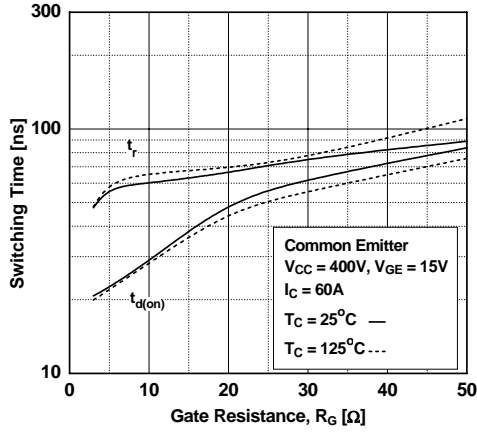

Figure 12. Turn off Switching SOA Characteristics



## Typical Performance Characteristics

**Figure 13. Turn-on Characteristics vs. Gate Resistance**



**Figure 14. Turn-off Characteristics vs. Gate Resistance**

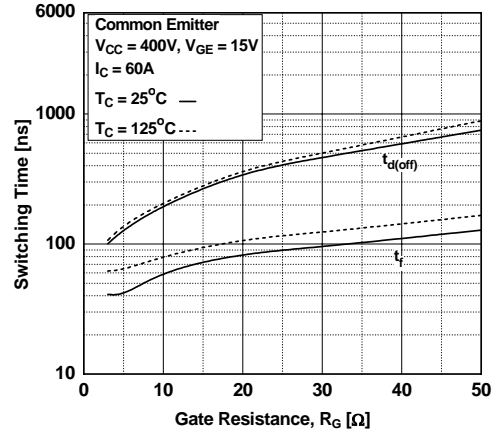

**Figure 15. Turn-on Characteristics vs. Collector Current**

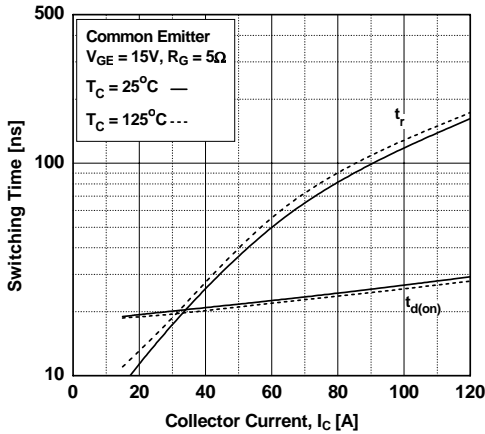

**Figure 16. Turn-off Characteristics vs. Collector Current**

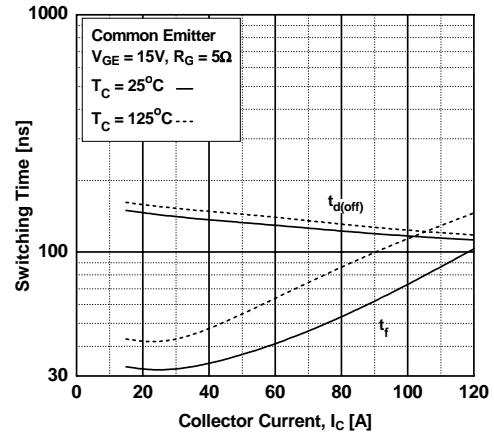

**Figure 17. Switching Loss vs. Gate Resistance**

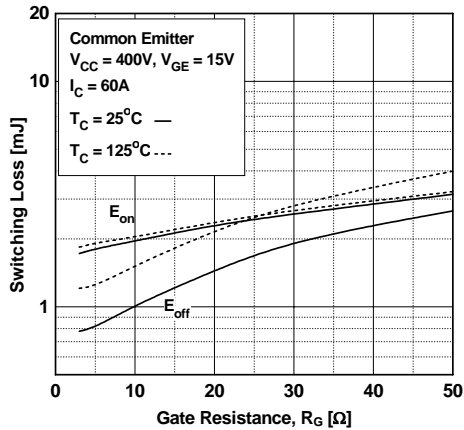

**Figure 18. Switching Loss vs. Collector Current**

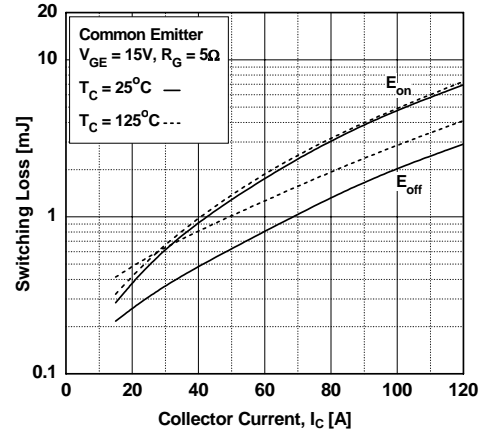

## Typical Performance Characteristics

Figure 19. Forward Characteristics

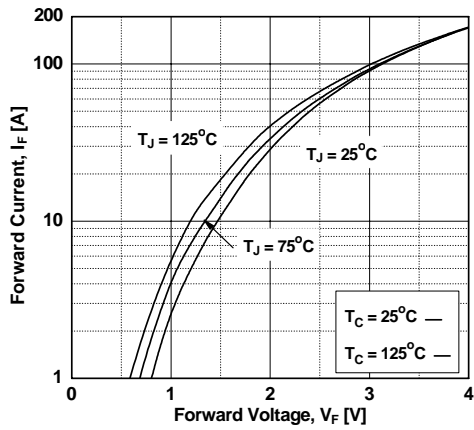

Figure 20. Reverse Current

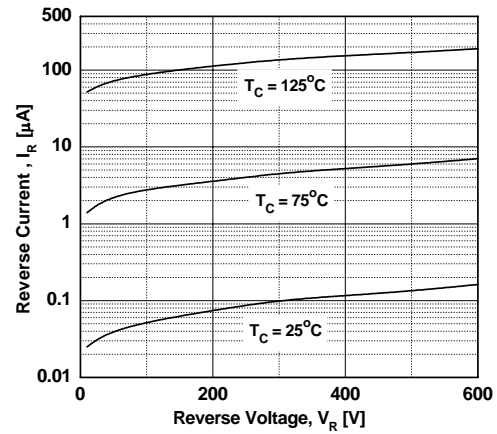

Figure 21. Stored Charge

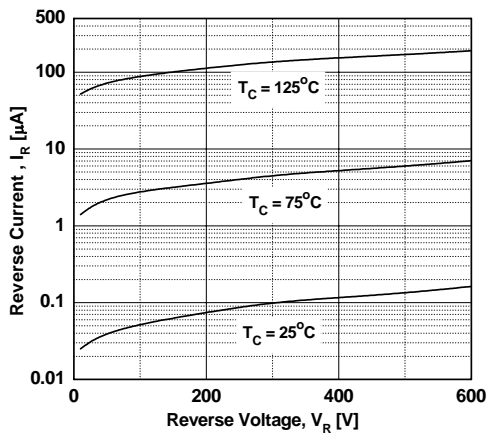

Figure 22. Reverse Recovery Time

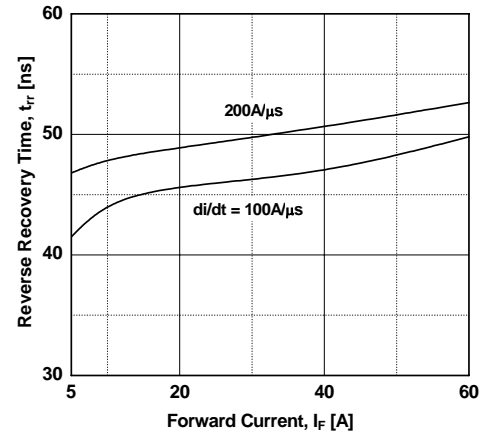
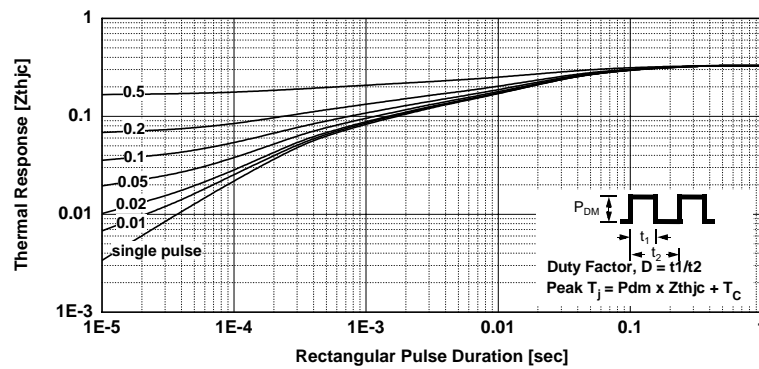
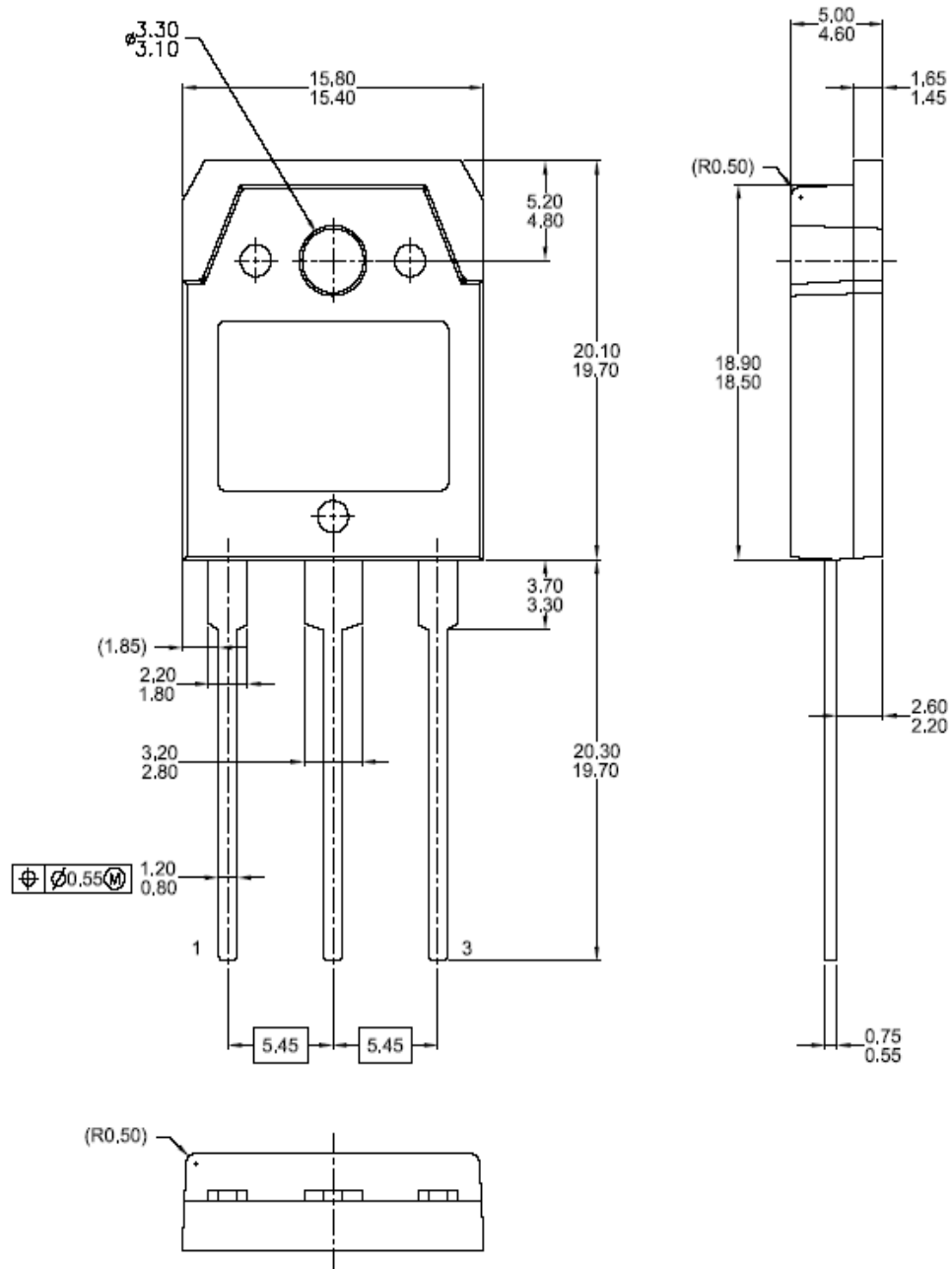

Figure 23. Transient Thermal Impedance of IGBT



Mechanical Dimensions

TO-3PN



Dimensions in Millimeters





**TRADEMARKS**

The following includes registered and unregistered trademarks and service marks, owned by Fairchild Semiconductor and/or its global subsidiaries, and is not intended to be an exhaustive list of all such trademarks.

- |  |   |   |   |
|--|---|---|---|
| Build it Now™  | FRFET®  | Programmable Active Droop™  | the power franchise™  |
| CorePLUS™  | Global Power Resource™  | QFET®   | TinyBoost™  |
| CorePOWER™   | Green FPS™  | QS™   | TinyBuck™   |
| CROSSVOLT™   | Green FPS™ e-Series™  | Quiet Series™   | TinyLogic®  |
| CTL™   | GTO™  | RapidConfigure™   | TINYOPTO™   |
| Current Transfer Logic™  | IntelliMAX™   |  ™ | TinyPower™  |
| EcoSPARK®  | ISOPLANAR™  | Saving our world, 1mW/W/kW at a time™   | TinyPWM™  |
| EfficientMax™  | MegaBuck™   | SmartMax™   | TinyWire™   |
| EZSWITCH™*   | MICROCOUPLER™   | SMART START™  | TriFault Detect™  |
|  ™* | MicroFET™   | SPM®  | TRUECURRENT™*   |
|  ®  | MicroPak™   | STEALTH™  | µSerDes™  |
| Fairchild®   | MillerDrive™  | SuperFET™   |  ™ |
| Fairchild Semiconductor®   | MotionMax™  | SuperSOT™-3   | UHC®  |
| FACT Quiet Series™   | Motion-SPM™   | SuperSOT™-6   | Ultra FRFET™  |
| FACT®  | OPTOLOGIC®  | SuperSOT™-8   | UniFET™   |
| FAST®  | OPTOPLANAR®   | SupreMOS™   | VCX™  |
| FastvCore™   |  ® | SyncFET™  | VisualMax™  |
| FlashWriter®*  | PDP SPM™  | SYSTEM®*  | XS™   |
| FPS™   | Power-SPM™  | GENERAL   |   |
| F-PFS™   | PowerTrench®  | The Power Franchise®  |   |
|  | PowerXS™  |   |   |

\* Trademarks of System General Corporation, used under license by Fairchild Semiconductor.

**DISCLAIMER**

FAIRCHILD SEMICONDUCTOR RESERVES THE RIGHT TO MAKE CHANGES WITHOUT FURTHER NOTICE TO ANY PRODUCTS HEREIN TO IMPROVE RELIABILITY, FUNCTION, OR DESIGN. FAIRCHILD DOES NOT ASSUME ANY LIABILITY ARISING OUT OF THE APPLICATION OR USE OF ANY PRODUCT OR CIRCUIT DESCRIBED HEREIN; NEITHER DOES IT CONVEY ANY LICENSE UNDER ITS PATENT RIGHTS, NOR THE RIGHTS OF OTHERS. THESE SPECIFICATIONS DO NOT EXPAND THE TERMS OF FAIRCHILD'S WORLDWIDE TERMS AND CONDITIONS, SPECIFICALLY THE WARRANTY THEREIN, WHICH COVERS THESE PRODUCTS.

**LIFE SUPPORT POLICY**

FAIRCHILD'S PRODUCTS ARE NOT AUTHORIZED FOR USE AS CRITICAL COMPONENTS IN LIFE SUPPORT DEVICES OR SYSTEMS WITHOUT THE EXPRESS WRITTEN APPROVAL OF FAIRCHILD SEMICONDUCTOR CORPORATION.

As used herein:

- Life support devices or systems are devices or systems which, (a) are intended for surgical implant into the body or (b) support or sustain life, and (c) whose failure to perform when properly used in accordance with instructions for use provided in the labeling, can be reasonably expected to result in a significant injury of the user.
- A critical component in any component of a life support, device, or system whose failure to perform can be reasonably expected to cause the failure of the life support device or system, or to affect its safety or effectiveness.

**ANTI-COUNTERFEITING POLICY**

Fairchild Semiconductor Corporation's Anti-Counterfeiting Policy. Fairchild's Anti-Counterfeiting Policy is also stated on our external website, [www.fairchildsemi.com](http://www.fairchildsemi.com), under Sales Support.

Counterfeiting of semiconductor parts is a growing problem in the industry. All manufacturers of semiconductor products are experiencing counterfeiting of their parts. Customers who inadvertently purchase counterfeit parts experience many problems such as loss of brand reputation, substandard performance, failed applications, and increased cost of production and manufacturing delays. Fairchild is taking strong measures to protect ourselves and our customers from the proliferation of counterfeit parts. Fairchild strongly encourages customers to purchase Fairchild parts either directly from Fairchild or from Authorized Fairchild Distributors who are listed by country on our web page cited above. Products customers buy either from Fairchild directly or from Authorized Fairchild Distributors are genuine parts, have full traceability, meet Fairchild's quality standards for handling and storage and provide access to Fairchild's full range of up-to-date technical and product information. Fairchild and our Authorized Distributors will stand behind all warranties and will appropriately address any warranty issues that may arise. Fairchild will not provide any warranty coverage or other assistance for parts bought from Unauthorized Sources. Fairchild is committed to combat this global problem and encourage our customers to do their part in stopping this practice by buying direct or from authorized distributors.

**PRODUCT STATUS DEFINITIONS**

**Definition of Terms**

Datasheet Identification	Product Status	Definition
Advance Information	Formative / In Design	Datasheet contains the design specifications for product development. Specifications may change in any manner without notice.
Preliminary	First Production	Datasheet contains preliminary data; supplementary data will be published at a later date. Fairchild Semiconductor reserves the right to make changes at any time without notice to improve design.
No Identification Needed	Full Production	Datasheet contains final specifications. Fairchild Semiconductor reserves the right to make changes at any time without notice to improve the design.
Obsolete	Not In Production	Datasheet contains specifications on a product that is discontinued by Fairchild Semiconductor. The datasheet is for reference information only.