

## FFPF08S60ST

### Features

- High Speed Switching,  $t_{rr} < 30\text{ns}$  @  $I_F = 8\text{A}$
- High Reverse Voltage and High Reliability
- RoHS component

### Applications

- General Purpose
- Switching Mode Power Supply
- Boost Diode in continuous mode power factor corrections
- Power switching circuits

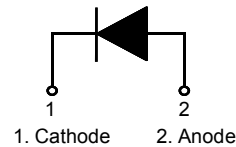
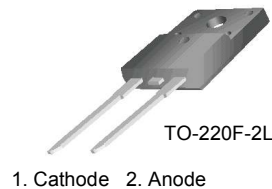


### 8A, 600V STEALTH™ II Rectifier

The FFPF08S60ST is STEALTH™ II rectifier with soft recovery characteristics. It is silicon nitride passivated ion-implanted epitaxial planar construction.

This device is intended for use as freewheeling of boost diode in switching power supplies and other power switching applications. Their low stored charge and hyperfast soft recovery minimize ringing and electrical noise in many power switching circuits reducing power loss in the switching transistors.

### Pin Assignments



### Absolute Maximum Ratings $T_C = 25^\circ\text{C}$ unless otherwise noted

Symbol	Parameter	Value	Units
$V_{RRM}$	Peak Repetitive Reverse Voltage	600	V
$V_{RWM}$	Working Peak Reverse Voltage	600	V
$V_R$	DC Blocking Voltage	600	V
$I_{F(AV)}$	Average Rectified Forward Current @ $T_C = 95^\circ\text{C}$	8	A
$I_{FSM}$	Non-repetitive Peak Surge Current 60Hz Single Half-Sine Wave	80	A
$T_J, T_{STG}$	Operating Junction and Storage Temperature	- 65 to +150	$^\circ\text{C}$

### Thermal Characteristics

Symbol	Parameter	Max	Units
$R_{\theta JC}$	Maximum Thermal Resistance, Junction to Case	3.4	$^\circ\text{C/W}$

### Package Marking and Ordering Information

Device Marking	Device	Package	Reel Size	Tape Width	Quantity
F08S60ST	FFPF08S60STTU	TO-220F-2L	-	-	50

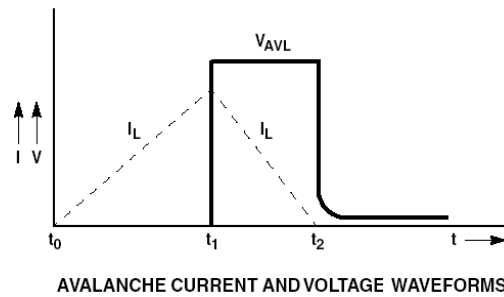
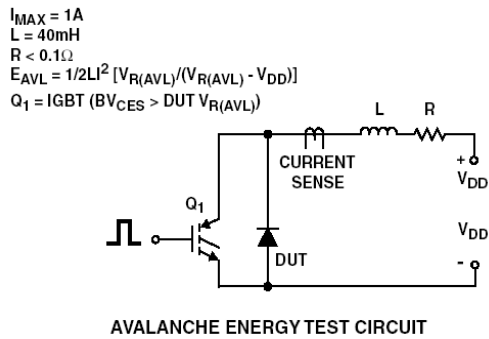
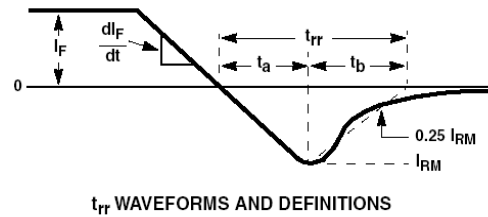
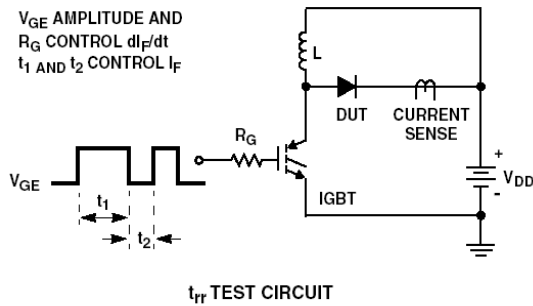
### Electrical Characteristics T<sub>C</sub> = 25 °C unless otherwise noted

Parameter	Conditions	Min.	Typ.	Max	Units	
V <sub>FM</sub> <sup>1</sup>	I <sub>F</sub> = 8A	T <sub>C</sub> = 25 °C	-	2.1	2.6	V
	I <sub>F</sub> = 8A	T <sub>C</sub> = 125 °C	-	1.6	-	V
I <sub>RM</sub> <sup>1</sup>	V <sub>R</sub> = 600V	T <sub>C</sub> = 25 °C	-	-	100	μA
	V <sub>R</sub> = 600V	T <sub>C</sub> = 125 °C	-	-	500	μA
t <sub>rr</sub>	I <sub>F</sub> = 1A, di/dt = 100A/μs, V <sub>R</sub> = 30V	T <sub>C</sub> = 25 °C	-	-	25	ns
t <sub>rr</sub>	I <sub>F</sub> = 8A, di/dt = 200A/μs, V <sub>R</sub> = 390V	T <sub>C</sub> = 25 °C	-	19	30	ns
I <sub>rr</sub>			-	2.2	-	A
S factor			-	0.6	-	-
Q <sub>rr</sub>			-	21	-	nC
t <sub>rr</sub>	I <sub>F</sub> = 8A, di/dt = 200A/μs, V <sub>R</sub> = 390V	T <sub>C</sub> = 125 °C	-	58	-	ns
I <sub>rr</sub>			-	4.3	-	A
S factor			-	1.3	-	-
Q <sub>rr</sub>			-	125	-	nC
W <sub>AVL</sub>	Avalanche Energy (L = 40mH)		20	-	-	mJ

**Notes:**

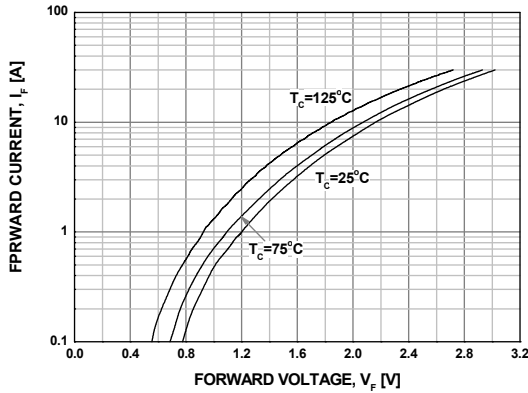
1. Pulse : Test Pulse width = 300μs, Duty Cycle = 2%

### Test Circuit and Waveforms

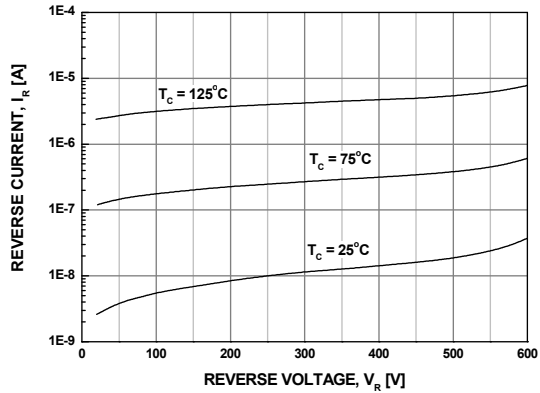


**Typical Performance Characteristics**  $T_c = 25^\circ\text{C}$  unless otherwise noted

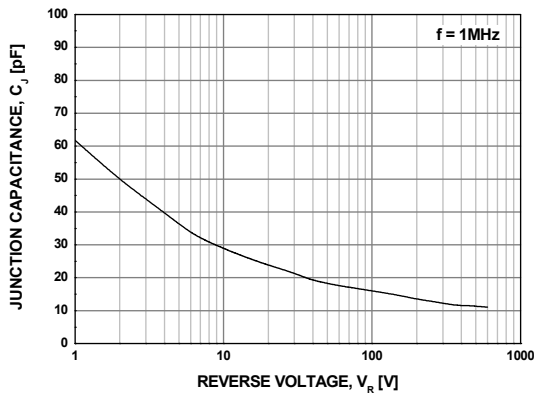
**Figure 1. Typical Forward Voltage Drop**



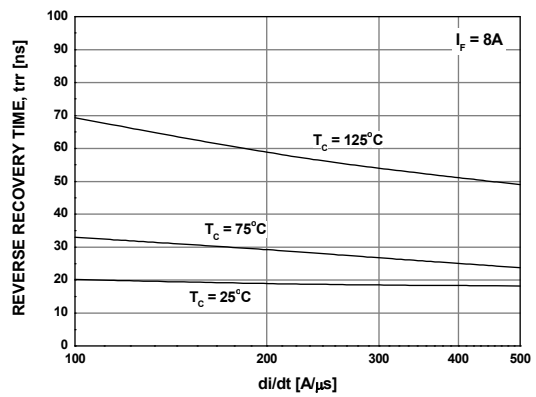
**Figure 2. Typical Reverse Current**



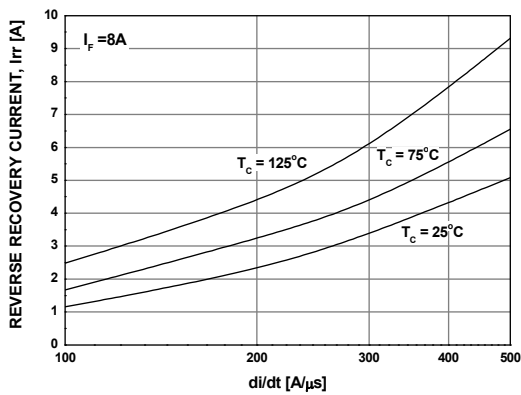
**Figure 3. Typical Junction Capacitance**



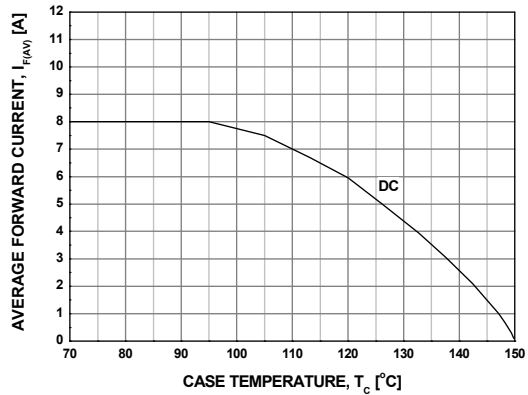
**Figure 4. Typical Reverse Recovery Time**



**Figure 5. Typical Reverse Recovery Current**

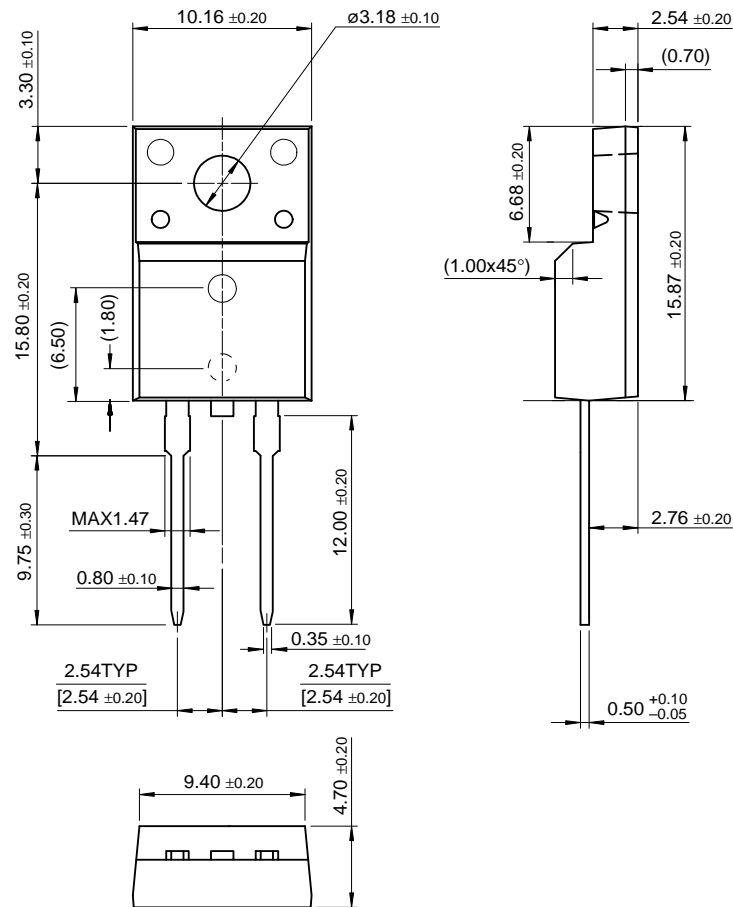


**Figure 6. Forward Current Deration Curve**



Mechanical Dimensions

TO-220F 2L




Dimensions in Millimeters



## TRADEMARKS

The following are registered and unregistered trademarks Fairchild Semiconductor owns or is authorized to use and is not intended to be an exhaustive list of all such trademarks.

ACEx <sup>®</sup>	GlobalOptoisolator <sup>™</sup>	Power247 <sup>®</sup>	SyncFET <sup>™</sup>
Across the board. Around the world.™	GTO <sup>™</sup>	PowerEdge <sup>™</sup>	TCM <sup>™</sup>
ActiveArray <sup>™</sup>	HiSeC <sup>™</sup>	PowerSaver <sup>™</sup>	The Power Franchise <sup>®</sup>
Bottomless <sup>™</sup>	<i>i-Lo</i> <sup>™</sup>	PowerTrench <sup>®</sup>	 ™
Build it Now <sup>™</sup>	ImpliedDisconnect <sup>™</sup>	Programmable Active Droop <sup>™</sup>	TinyBoost <sup>™</sup>
CoolFET <sup>™</sup>	IntelliMAX <sup>™</sup>	QFET <sup>®</sup>	TinyBuck <sup>™</sup>
CROSSVOLT <sup>™</sup>	ISOPLANAR <sup>™</sup>	QS <sup>™</sup>	TinyLogic <sup>®</sup>
CTL <sup>™</sup>	MICROCOUPLER <sup>™</sup>	QT Optoelectronics <sup>™</sup>	TINYOPTO <sup>™</sup>
Current Transfer Logic <sup>™</sup>	MicroPak <sup>™</sup>	Quiet Series <sup>™</sup>	TinyPower <sup>™</sup>
DOME <sup>™</sup>	MICROWIRE <sup>™</sup>	RapidConfigure <sup>™</sup>	TinyWire <sup>™</sup>
E <sup>2</sup> CMOS <sup>™</sup>	MSX <sup>™</sup>	RapidConnect <sup>™</sup>	TruTranslation <sup>™</sup>
EcoSPARK <sup>®</sup>	MSXPro <sup>™</sup>	ScalarPump <sup>™</sup>	μSerDes <sup>™</sup>
EnSigna <sup>™</sup>	OCX <sup>™</sup>	SMART START <sup>™</sup>	UHC <sup>®</sup>
FACT Quiet Series <sup>™</sup>	OCXPro <sup>™</sup>	SPM <sup>®</sup>	UniFET <sup>™</sup>
FACT <sup>®</sup>	OPTOLOGIC <sup>®</sup>	STEALTH <sup>™</sup>	VCX <sup>™</sup>
FAST <sup>®</sup>	OPTOPLANAR <sup>®</sup>	SuperFET <sup>™</sup>	Wire <sup>™</sup>
FASTr <sup>™</sup>	PACMAN <sup>™</sup>	SuperSOT <sup>™</sup> -3	
FPS <sup>™</sup>	POP <sup>™</sup>	SuperSOT <sup>™</sup> -6	
FRFET <sup>®</sup>	Power220 <sup>®</sup>	SuperSOT <sup>™</sup> -8	

## DISCLAIMER

FAIRCHILD SEMICONDUCTOR RESERVES THE RIGHT TO MAKE CHANGES WITHOUT FURTHER NOTICE TO ANY PRODUCTS HEREIN TO IMPROVE RELIABILITY, FUNCTION, OR DESIGN. FAIRCHILD DOES NOT ASSUME ANY LIABILITY ARISING OUT OF THE APPLICATION OR USE OF ANY PRODUCT OR CIRCUIT DESCRIBED HEREIN; NEITHER DOES IT CONVEY ANY LICENSE UNDER ITS PATENT RIGHTS, NOR THE RIGHTS OF OTHERS. THESE SPECIFICATIONS DO NOT EXPAND THE TERMS OF FAIRCHILD'S WORLDWIDE TERMS AND CONDITIONS, SPECIFICALLY THE WARRANTY THEREIN, WHICH COVERS THESE PRODUCTS.

## LIFE SUPPORT POLICY

FAIRCHILD'S PRODUCTS ARE NOT AUTHORIZED FOR USE AS CRITICAL COMPONENTS IN LIFE SUPPORT DEVICES OR SYSTEMS WITHOUT THE EXPRESS WRITTEN APPROVAL OF FAIRCHILD SEMICONDUCTOR CORPORATION.

As used herein:

1. Life support devices or systems are devices or systems which, (a) are intended for surgical implant into the body, or (b) support or sustain life, and (c) whose failure to perform when properly used in accordance with instructions for use provided in the labeling, can be reasonably expected to result in significant injury to the user.
2. A critical component is any component of a life support device or system whose failure to perform can be reasonably expected to cause the failure of the life support device or system, or to affect its safety or effectiveness.

## PRODUCT STATUS DEFINITIONS

### Definition of Terms

Datasheet Identification	Product Status	Definition
Advance Information	Formative or In Design	This datasheet contains the design specifications for product development. Specifications may change in any manner without notice.
Preliminary	First Production	This datasheet contains preliminary data; supplementary data will be published at a later date. Fairchild Semiconductor reserves the right to make changes at any time without notice to improve design.
No Identification Needed	Full Production	This datasheet contains final specifications. Fairchild Semiconductor reserves the right to make changes at any time without notice to improve design.
Obsolete	Not In Production	This datasheet contains specifications on a product that has been discontinued by Fairchild semiconductor. The datasheet is printed for reference information only.