

# LM336Z5 • LM336BZ5

## Programmable Shunt Regulator

### General Description

The LM336Z5 and LM336BZ5 integrated circuits are precision 5.0V shunt regulators. The monolithic IC voltage reference operates as a low temperature coefficient 5.0V zener with 0.6Ω dynamic impedance. A third terminal on the LM336Z5 and LM336BZ5 allows the reference voltage and temperature coefficient to be trimmed easily.

The LM336Z5 and LM336BZ5 are useful as precision 5.0V low voltage references which makes it convenient to obtain a stable reference from low voltage supplies. Further, since the LM336Z5 and LM336BZ5 operate as shunt regulators, they can be used as either a positive or negative voltage reference.

### Features

- Low Temperature Coefficient
- Adjustable 4V to 6V
- Wide Operating Range Current of 10mA to 400mA
- Three Lead Transistor Package (TO-92)
- 0.6Ω Dynamic Impedance
- ±1.0% Initial Tolerance Available
- Guaranteed Temperature Stability
- Easily Trimmed for Minimum Temperature Drift
- Fast Turn On

### Ordering Code:

Product Number	Package	Packing	Operating Temperature
LM336Z5	TO-92	Bulk	0°C to +70°C
LM336Z5X		Tape and Reel	
LM336BZ50		Bulk	

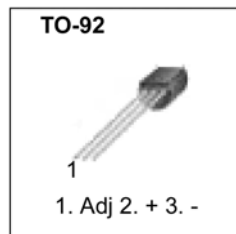

### Internal Block Diagram

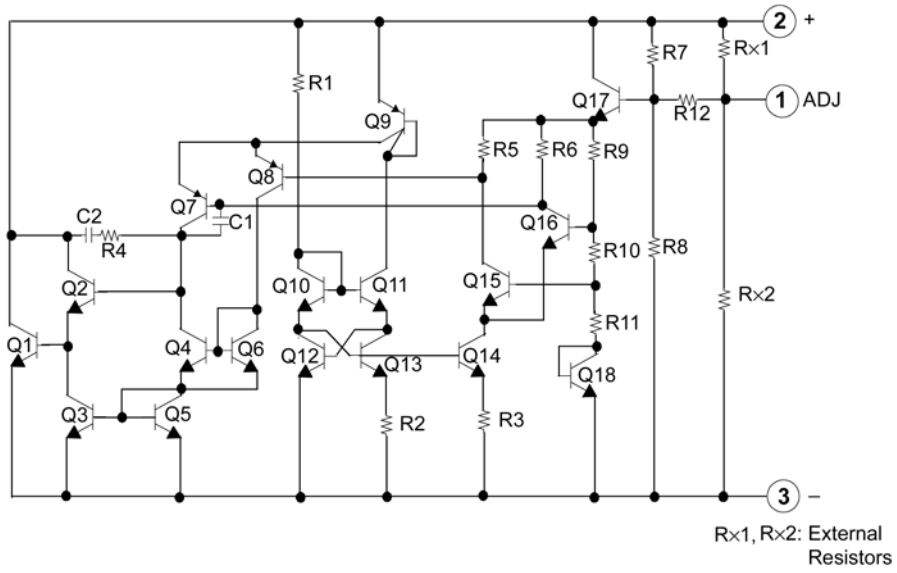

**Absolute Maximum Ratings**(Note 1)

Parameter	Symbol	Value	Unit
Reverse Current	IR	15	mA
Forward Current	IF	10	mA
Operating Temperature Range	TOPR	0 ~ +70	°C
Storage Temperature Range	TSTG	- 60 ~ +150	°C

**Note 1:** The Absolute Maximum Ratings are those values beyond which the safety of the device cannot be guaranteed. The device should not be operated at these limits. The parametric values defined in the Electrical Characteristics tables are not guaranteed at the absolute maximum rating.

**Electrical Characteristics** ( $0^{\circ}\text{C} < T_A < +70^{\circ}\text{C}$ , unless otherwise specified)

Parameter	Symbol	Conditions	LM336Z5			LM336BZ5			Unit
			Min	Typ	Max	Min	Typ	Max	
Reverse Breakdown Voltage	$V_R$	$T_A = +25^{\circ}\text{C}$ , $I_R = 1\text{mA}$	4.8	5.0	5.2	4.9	5.0	5.1	V
Reverse Breakdown Change with Current	$\Delta V_R/\Delta I_R$	$T_A = +25^{\circ}\text{C}$ , $600\mu\text{A} \leq I_R \leq 10\text{mA}$	-	6.0	20.0	-	6.0	20.0	mV
Reverse Dynamic Impedance	$Z_D$	$T_A = +25^{\circ}\text{C}$ , $I_R = 1\text{mA}$	-	0.6	2.0	-	0.6	2.0	$\Omega$
Temperature Stability	$ST_T$	$I_R = 1\text{mA}$	-	4.0	12.0	-	4.0	12.0	mV
Reverse Breakdown Change with Current	$\Delta V_R/\Delta I_R$	$600\mu\text{A} \leq I_R \leq 10\text{mA}$	-	6.0	24.0	-	6.0	24.0	mV
Reverse Dynamic Impedance	ZD	$I_R = 1\text{mA}$	-	0.8	2.5	-	0.8	2.5	$\Omega$
Long Term Stability In Reference Voltage	ST	$I_R = 1\text{mA}$	-	20.0	-	-	20.0	-	ppm/Khr

### Typical Performance Characteristics

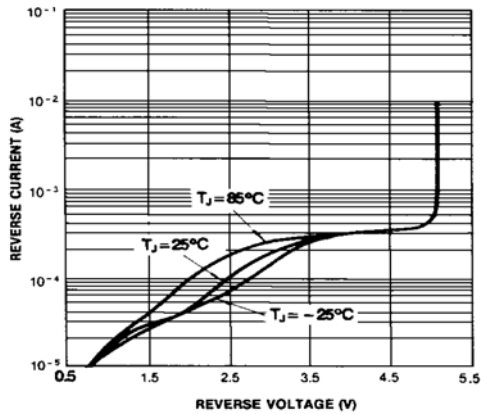

FIGURE 1. Reverse Voltage Change

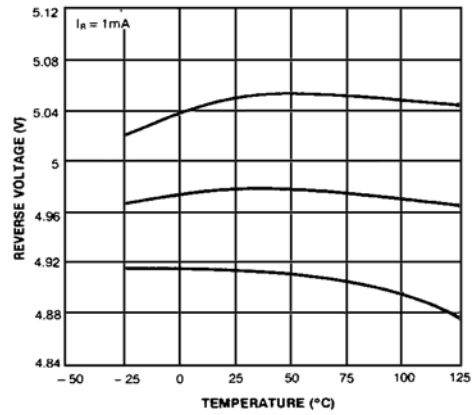

FIGURE 2. Reverse Characteristics

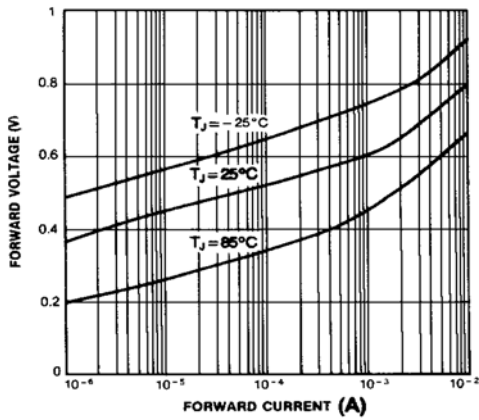

FIGURE 3. Temperature (°C)

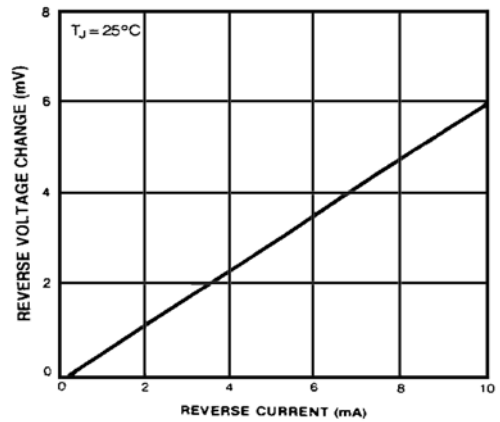

FIGURE 4. Forward Characteristics

**Physical Dimensions** inches (millimeters) unless otherwise noted

Package

Dimensions in millimeters

**TO-92**

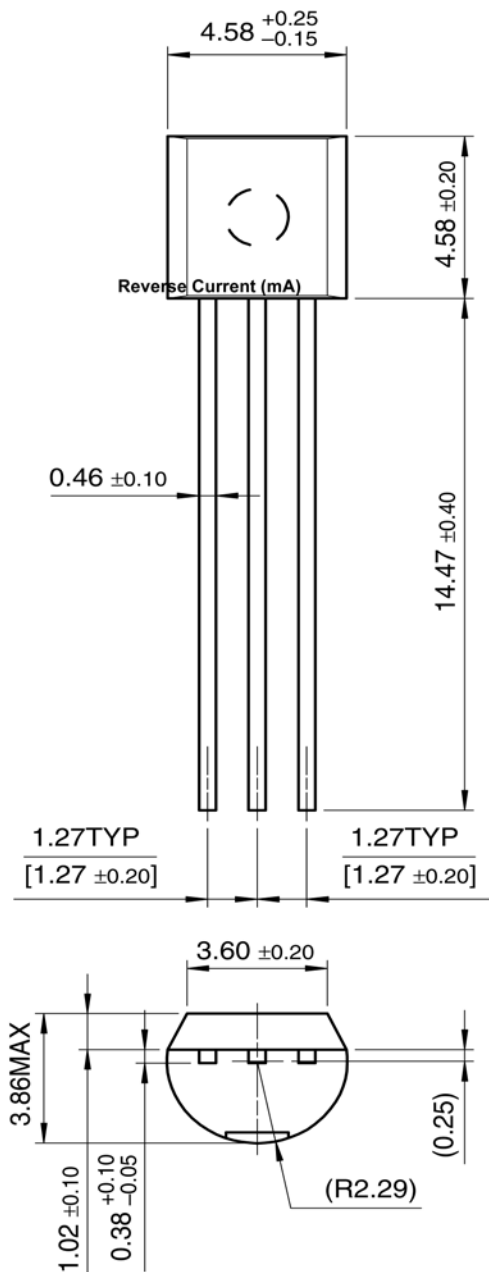

## DISCLAIMER

FAIRCHILD SEMICONDUCTOR RESERVES THE RIGHT TO MAKE CHANGES WITHOUT FURTHER NOTICE TO ANY PRODUCTS HEREIN TO IMPROVE RELIABILITY, FUNCTION OR DESIGN. FAIRCHILD DOES NOT ASSUME ANY LIABILITY ARISING OUT OF THE APPLICATION OR USE OF ANY PRODUCT OR CIRCUIT DESCRIBED HEREIN; NEITHER DOES IT CONVEY ANY LICENSE UNDER ITS PATENT RIGHTS, NOR THE RIGHTS OF OTHERS.

## LIFE SUPPORT POLICY

FAIRCHILD'S PRODUCTS ARE NOT AUTHORIZED FOR USE AS CRITICAL COMPONENTS IN LIFE SUPPORT DEVICES OR SYSTEMS WITHOUT THE EXPRESS WRITTEN APPROVAL OF FAIRCHILD SEMICONDUCTOR CORPORATION

As used herein:

1. Life support devices or systems are devices or systems which, (a) are intended for surgical implant into the body, or (b) support or sustain life, or (c) whose failure to perform when properly used in accordance with instructions for use

provided in the labeling, can be reasonably expected to result in significant injury to the user.

2. A critical component is any component of a life support device or system whose failure to perform can be reasonably expected to cause the failure of the life support device or system, or to affect its safety or effectiveness.

## PRODUCT STATUS DEFINITIONS

Definition of terms

Datasheet Identification	Product Status	Definition
Advance Information	Formative or In Design	This datasheet contains the design specifications for product development. Specifications may change in any manner without notice.
Preliminary	First Production	This datasheet contains preliminary data, and supplementary data will be published at a later date. Fairchild Semiconductor reserves the right to make changes at any time without notice in order to improve design.
No Identification Needed	Full Production	This datasheet contains final specifications. Fairchild Semiconductor reserves the right to make changes at any time without notice in order to improve design.
Obsolete	Not In Production	This datasheet contains specifications on a product that has been discontinued by Fairchild Semiconductor. The datasheet is printed for reference information only.