

# CoolMOS™ 1) Power MOSFET with SiC Diode Boost topology

$I_{D25} = 15 \text{ A}$   
 $V_{DSS} = 600 \text{ V}$   
 $R_{DS(on) \text{ max}} = 0.165 \Omega$

Electrically isolated back surface  
2500 V electrical isolation

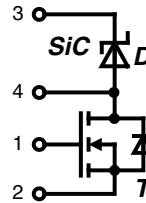

ISOPLUS i4™

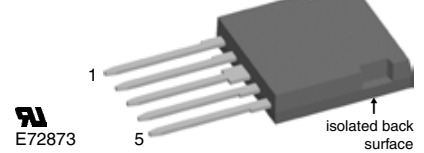

MOSFET T			
Symbol	Conditions	Maximum Ratings	
$V_{DSS}$	$T_{VJ} = 25^\circ\text{C}$	600	V
$V_{GS}$		$\pm 20$	V
$I_{D25}$	$T_C = 25^\circ\text{C}$	15	A
$I_{D90}$	$T_C = 90^\circ\text{C}$	11	A
$E_{AS}$ $E_{AR}$	single pulse repetitive } $I_D = 7.9 \text{ A}; T_C = 25^\circ\text{C}$	522 0.79	mJ mJ
$dV/dt$	MOSFET $dV/dt$ ruggedness $V_{DS} = 0 \dots 480 \text{ V}$	50	V/ns

## Features

- Silicon chip on Direct-Copper-Bond substrate
  - high power dissipation
  - isolated mounting surface
  - 2500 V electrical isolation
  - low drain to tab capacitance ( $< 40 \text{ pF}$ )
- Fast CoolMOS™ 1) power MOSFET 4<sup>th</sup> generation
  - high blocking capability
  - lowest resistance
  - avalanche rated for unclamped inductive switching (UIS)
  - low thermal resistance due to reduced chip thickness
- Enhanced total power density
- SiC Boost Diode
  - no reverse recovery current

Symbol	Conditions	Characteristic Values			
		$(T_{VJ} = 25^\circ\text{C}, \text{ unless otherwise specified})$			
		min.	typ.	max.	
$R_{DS(on)}$	$V_{GS} = 10 \text{ V}; I_D = 12 \text{ A}$		150	165	mΩ
$V_{GS(th)}$	$V_{DS} = V_{GS}; I_D = 0.79 \text{ mA}$	2.5	3	3.5	V
$I_{DSS}$	$V_{DS} = 600 \text{ V}; V_{GS} = 0 \text{ V}$ $T_{VJ} = 25^\circ\text{C}$ $T_{VJ} = 125^\circ\text{C}$		10	1	$\mu\text{A}$ $\mu\text{A}$
$I_{GSS}$	$V_{GS} = \pm 20 \text{ V}; V_{DS} = 0 \text{ V}$			100	nA
$C_{iss}$ $C_{oss}$	$V_{GS} = 0 \text{ V}; V_{DS} = 100 \text{ V}$ $f = 1 \text{ MHz}$		2000 100		pF pF
$Q_g$ $Q_{gs}$ $Q_{gd}$	$V_{GS} = 0 \text{ to } 10 \text{ V}; V_{DS} = 400 \text{ V}; I_D = 12 \text{ A}$		40 9 13	52	nC nC nC
$t_{d(on)}$ $t_r$ $t_{d(off)}$ $t_f$ $E_{on}$ $E_{off}$ $E_{rec off}$	Inductive switching $T_{VJ} = 125^\circ\text{C}$ $V_{GS} = 0/10 \text{ V}; V_{DS} = 380 \text{ V}$ $I_D = 12 \text{ A}; R_G = 10 \Omega$ no reverse recovery current due to absence of minority carrier injection		12 6 75 4 0.09 0.01		ns ns ns ns mJ mJ mJ
$R_{thJC}$ $R_{thJH}$	with heat transfer paste (IXYS test setup)		1.35	1.1	K/W K/W

## Applications

- Switched mode power supplies (SMPS)
- Uninterruptible power supplies (UPS)
- Power factor correction (PFC)

## Advantages

- Easy assembly: no screws or isolation foils required
- Space savings
- High power density
- High reliability

1) CoolMOS™ is a trademark of Infineon Technologies AG.

**MOSFET T Source-Drain Diode**

Symbol	Conditions	Characteristic Values		
		min.	typ.	max.
(T <sub>VJ</sub> = 25°C, unless otherwise specified)				
I <sub>S</sub>	V <sub>GS</sub> = 0 V			12 A
V <sub>SD</sub>	I <sub>F</sub> = 12 A; V <sub>GS</sub> = 0 V	0.9	1.2	V
t <sub>rr</sub>	I <sub>F</sub> = 12 A; -di <sub>F</sub> /dt = 100 A/μs; V <sub>R</sub> = 400 V		390	ns
Q <sub>RM</sub>			7.5	μC
I <sub>RM</sub>			38	A

**SiC Boost Diode D**

Symbol	Conditions	Maximum Ratings	
V <sub>RRM</sub>	T <sub>VJ</sub> = 25°C to 150°C	600	V
I <sub>F25</sub>	T <sub>C</sub> = 25°C	15	A
I <sub>F90</sub>	T <sub>C</sub> = 90°C	9.5	A

Symbol	Conditions	Characteristic Values		
		min.	typ.	max.
V <sub>F</sub>	I <sub>F</sub> = 8 A	T <sub>VJ</sub> = 25°C	1.5	1.7 V
	I <sub>F</sub> = 8 A	T <sub>VJ</sub> = 150°C		1.9 A
I <sub>R</sub>	V <sub>R</sub> = V <sub>RRM</sub>	T <sub>VJ</sub> = 25°C	1	100 μA
		T <sub>VJ</sub> = 150°C	10	μA
I <sub>FSM</sub>	t = 10 ms (50 Hz), sine;	T <sub>VJ</sub> = 25°C		59 A
Q <sub>C</sub>	I <sub>F</sub> = I <sub>Fmax</sub> ; V <sub>R</sub> = 400 V;	T <sub>VJ</sub> = 150°C	19	nC
t <sub>C</sub>	di/dt = 200 A/μs <sup>1)</sup>			10 ns
R <sub>thJC</sub>	} with heat transfer paste (IXYS test setup)		3.1	K/W
R <sub>thJH</sub>			4.0	K/W

<sup>1)</sup> t<sub>C</sub> is the time constant for the capacitive displacement current waveform (independent from T<sub>J</sub>, I<sub>LOAD</sub> and di/dt), different from t<sub>r</sub>, which is dependent on T<sub>J</sub>, I<sub>LOAD</sub> and di/dt.

No reverse recovery time constant trr due to absence of minority carrier injection

**Component**

Symbol	Conditions	Maximum Ratings	
T <sub>VJ</sub>	operating	-55...+150	°C
T <sub>stg</sub>	storage	-55...+125	°C
V <sub>ISOL</sub>	I <sub>ISOL</sub> < 1 mA; 50/60 Hz	2500	V~
F <sub>C</sub>	mounting force with clip	20...120	N

Symbol	Conditions	Characteristic Values		
		min.	typ.	max.
C <sub>p</sub>	coupling capacity between shorted pins and mounting tab in the case		40	pF
d <sub>S</sub> , d <sub>A</sub>	pin - pin	1.7		mm
d <sub>S</sub> , d <sub>A</sub>	pin - backside metal	5.5		mm
Weight			9	g

## ISOPLUS i4™ Outline

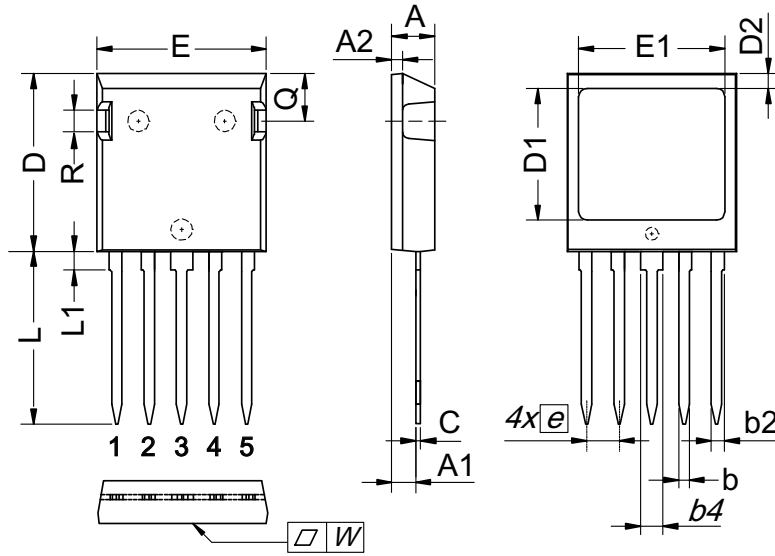

DIM.	MILLIMETER		INCHES	
	MIN	MAX	MIN	MAX
A	4.83	5.21	0.190	0.205
A1	2.59	3.00	0.102	0.118
A2	1.17	2.16	0.046	0.085
b	1.14	1.40	0.045	0.055
b2	1.47	1.73	0.058	0.068
b4	2.54	2.79	0.100	0.110
C	0.51	0.74	0.020	0.029
D	20.80	21.34	0.819	0.840
D1	14.99	15.75	0.590	0.620
D2	1.65	2.03	0.065	0.080
E	19.56	20.29	0.770	0.799
E1	16.76	17.53	0.660	0.690
e	3.81 BSC		0.15 BSC	
L	19.81	21.34	0.780	0.840
L1	2.11	2.59	0.083	0.102
Q	5.33	6.20	0.210	0.244
R	2.54	4.57	0.100	0.180
W	0.10		0.004	

Die konvexe Form des Substrates ist typ. <math>< 0.05\text{ mm}</math> über der Kunststoffoberfläche der Bauteilunterseite  
 The convex bow of substrate is typ. <math>< 0.05\text{ mm}</math> over plastic surface level of device bottom side

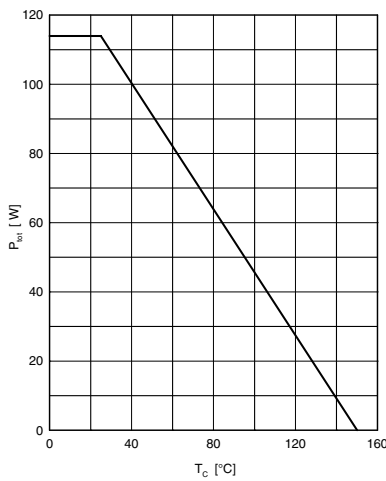

Fig. 1 Power dissipation

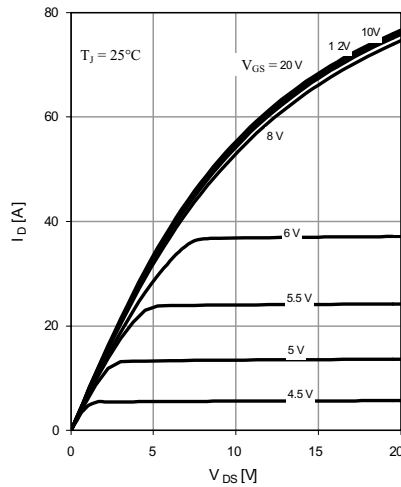

Fig. 2 Typ. output characteristics

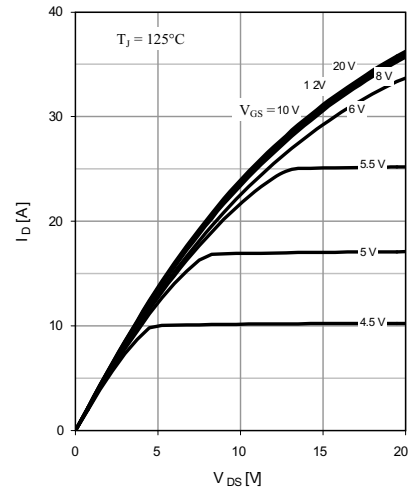

Fig. 3 Typ. output characteristics

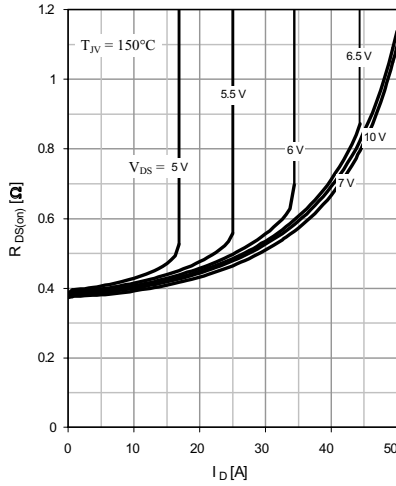

Fig. 4 Typ. drain-source on-state resistance

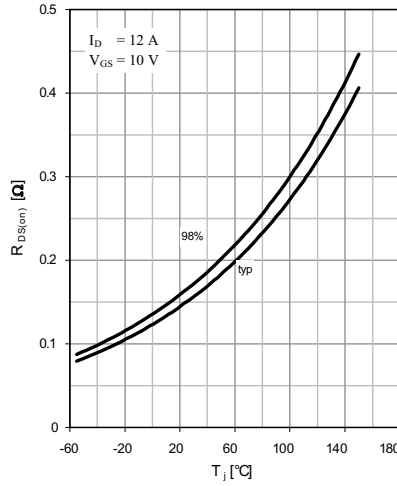

Fig. 5 Drain-source on-state resistance

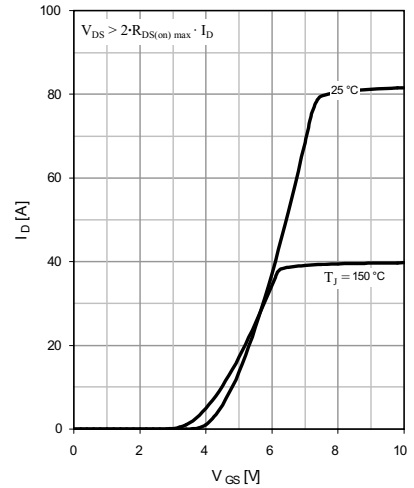

Fig. 6 Typ. transfer characteristics

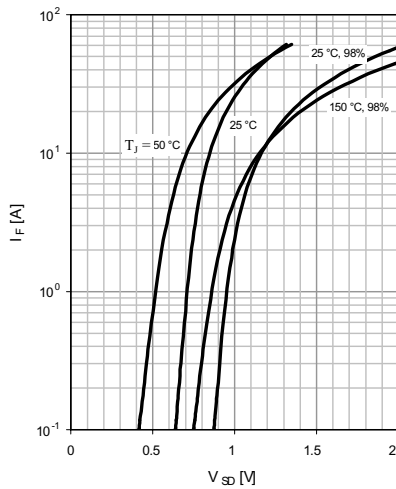

Fig. 7 Forward characteristic of reverse diode

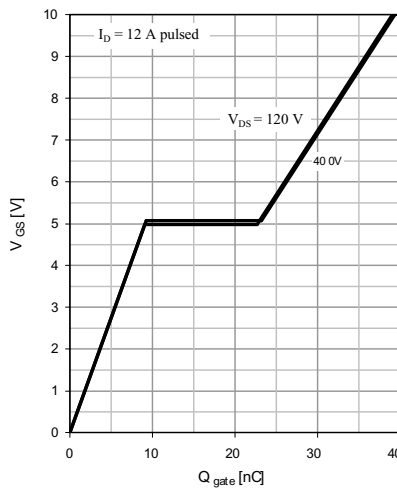

Fig. 8 Typ. gate charge

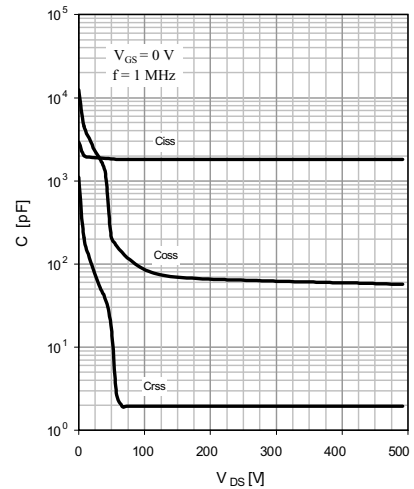

Fig. 9 Typ. capacitances

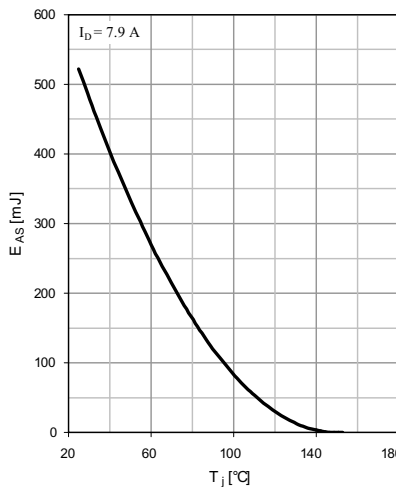

Fig. 10 Avalanche energy

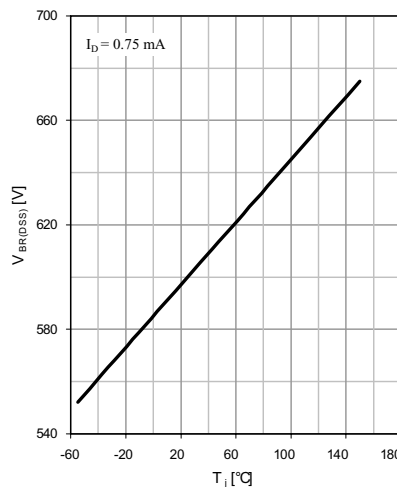

Fig. 11 Drain-source breakdown voltage

IXYS reserves the right to change limits, test conditions and dimensions.

20100920a

© 2010 IXYS All rights reserved

4 - 6

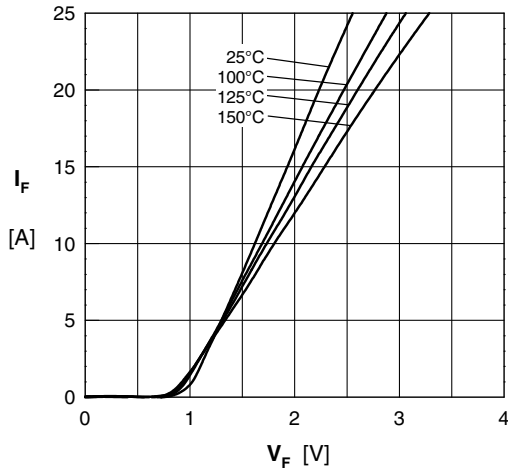

Fig. 12 Forward characteristic of boost diode

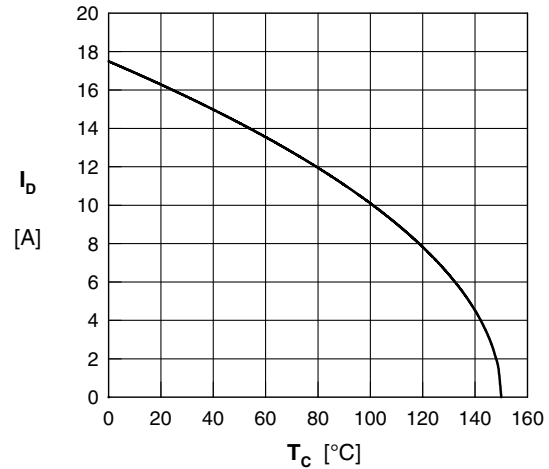

Fig. 13 Drain current  $I_D$  versus case temperature  $T_C$

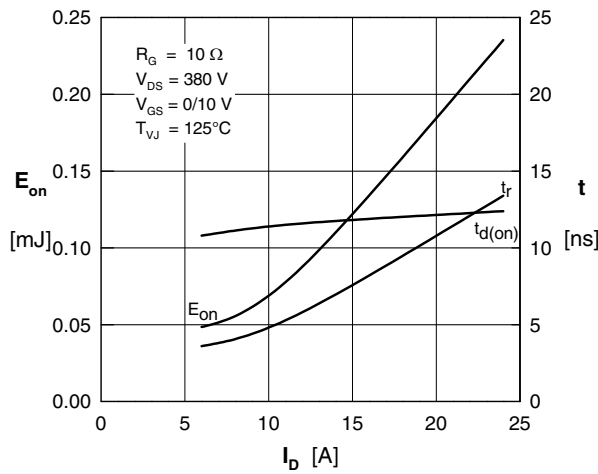

Fig. 14 Typ. turn-on energy and switching times versus drain current, inductive switching

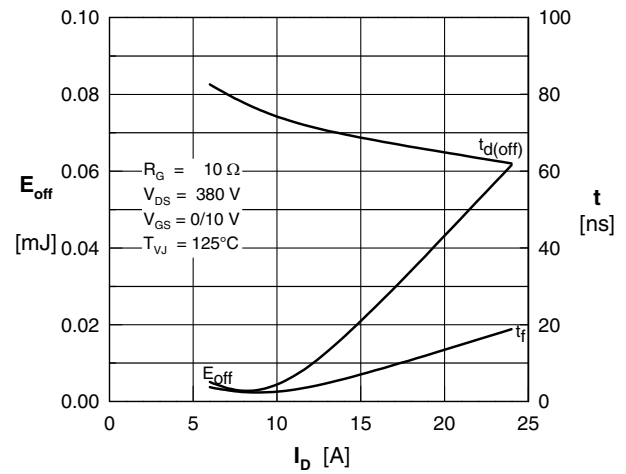

Fig. 15 Typ. turn-off energy and switching times versus drain current, inductive switching

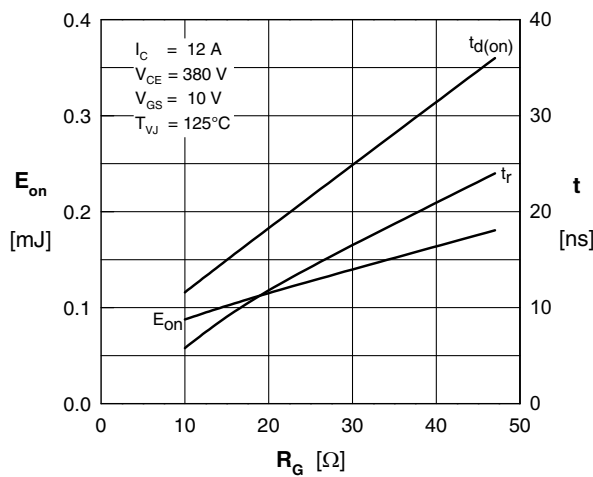

Fig. 16 Typ. turn-on energy and switching times versus gate resistor, inductive switching

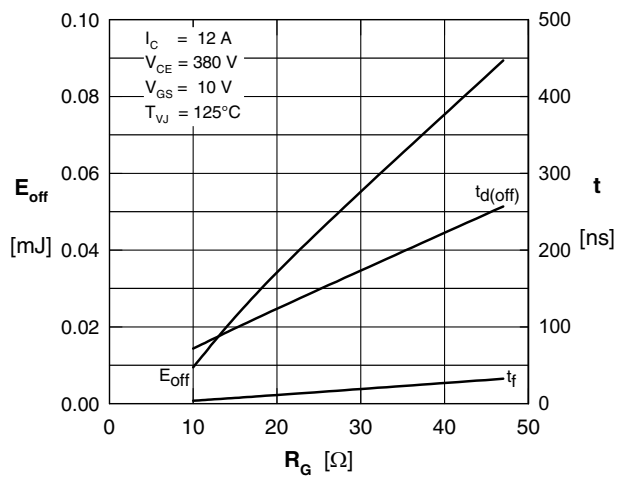

Fig. 17 Typ. turn-off energy and switching times versus gate resistor, inductive switching

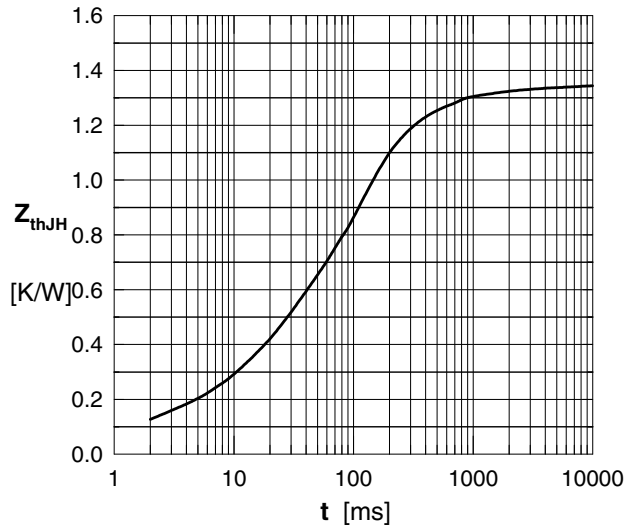

Fig. 18 Typ. transient thermal impedances of IGBT with heat transfer paste (IXYS test setup)

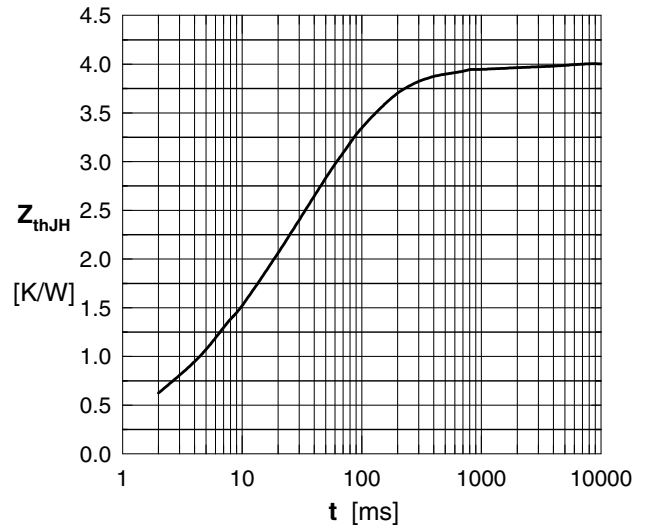

Fig. 19 Typ. transient thermal impedances of boost diode with heat transfer paste (IXYS test setup)

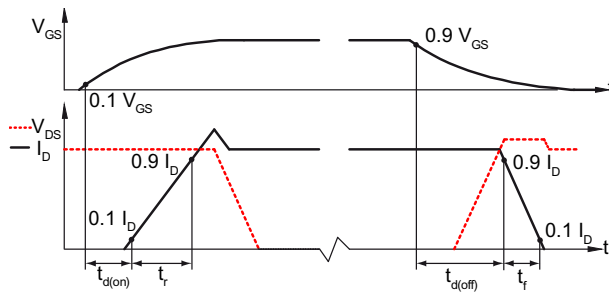

Fig. 20 Definition of switching times