

HiPerFRED™ Epitaxial Diode

with common cathode and soft recovery

$$I_{FAV} = 2 \times 10 \text{ A}$$

$$V_{RRM} = 1200 \text{ V}$$

$$t_{rr} = 40 \text{ ns}$$

V_{RSM}	V_{RRM}	Type
V	V	
1200	1200	DSEC 16-12AS

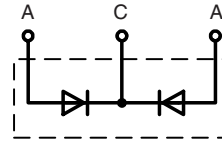

TO-263 AB

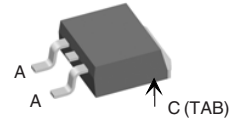

A = Anode, C/TAB = Cathode

Symbol	Conditions	Maximum Ratings	
I_{FRMS}		14	A
I_{FAVM}	$T_C = 115^\circ\text{C}$; rectangular, $d = 0.5$	10	A
I_{FSM}	$T_{VJ} = 45^\circ\text{C}$; $t_p = 10 \text{ ms}$ (50 Hz), sine	40	A
E_{AS}	$T_{VJ} = 25^\circ\text{C}$; non-repetitive $I_{AS} = 8 \text{ A}$; $L = 180 \mu\text{H}$	6.9	mJ
I_{AR}	$V_A = 1.25 \cdot V_R$ typ.; $f = 10 \text{ kHz}$; repetitive	0.8	A
T_{VJ}		-55...+175	$^\circ\text{C}$
T_{VJM}		175	$^\circ\text{C}$
T_{stg}		-55...+150	$^\circ\text{C}$
P_{tot}	$T_C = 25^\circ\text{C}$	60	W
F_C	mounting force	20...60	N
Weight	typical	2	g

Features

- International standard package
- Planar passivated chips
- Very short recovery time
- Extremely low switching losses
- Low I_{RM} -values
- Soft recovery behaviour
- Epoxy meets UL 94V-0

Applications

- Antiparallel diode for high frequency switching devices
- Antisaturation diode
- Snubber diode
- Free wheeling diode in converters and motor control circuits
- Rectifiers in switch mode power supplies (SMPS)
- Inductive heating
- Uninterruptible power supplies (UPS)
- Ultrasonic cleaners and welders

Advantages

- Avalanche voltage rated for reliable operation
- Soft reverse recovery for low EMI/RFI
- Low I_{RM} reduces:
 - Power dissipation within the diode
 - Turn-on loss in the commutating switch

Dimensions see Outlines.pdf

Symbol	Conditions	Characteristic Values	
		typ.	max.
I_R *	$T_{VJ} = 25^\circ\text{C}$ $V_R = V_{RRM}$ $T_{VJ} = 150^\circ\text{C}$ $V_R = V_{RRM}$	60	μA
V_F *	$I_F = 10 \text{ A}$; $T_{VJ} = 150^\circ\text{C}$ $T_{VJ} = 25^\circ\text{C}$	1.96	V
		2.94	V
R_{thJC}		2.5	K/W
R_{thCH}	0.5		K/W
t_{rr}	$I_F = 1 \text{ A}$; $-di/dt = 50 \text{ A}/\mu\text{s}$; $V_R = 30 \text{ V}$; $T_{VJ} = 25^\circ\text{C}$	40	ns
I_{RM}	$V_R = 100 \text{ V}$; $I_F = 12 \text{ A}$; $-di_F/dt = 100 \text{ A}/\mu\text{s}$ $T_{VJ} = 100^\circ\text{C}$	8.5	A

Pulse test: * Pulse Width = 5 ms, Duty Cycle < 2.0%
* Pulse Width = 300 μs , Duty Cycle < 2.0%

Data according to IEC 60747 and per diode unless otherwise specified

IXYS reserves the right to change limits, test conditions and dimensions.

20080811a

© 2008 IXYS All rights reserved

1 - 3

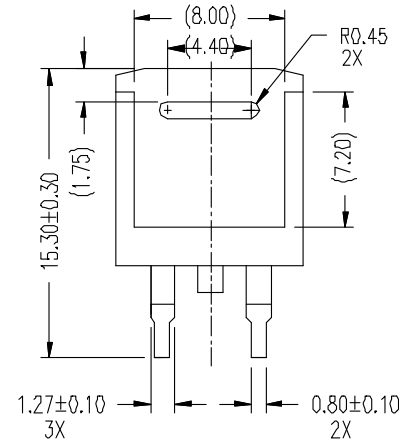
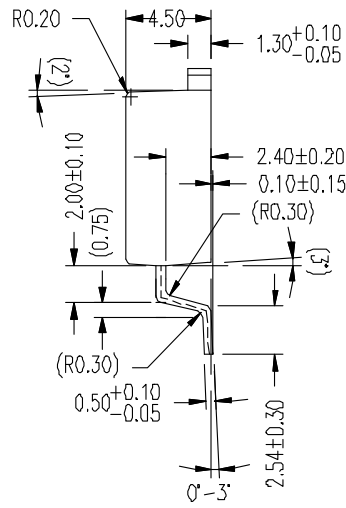
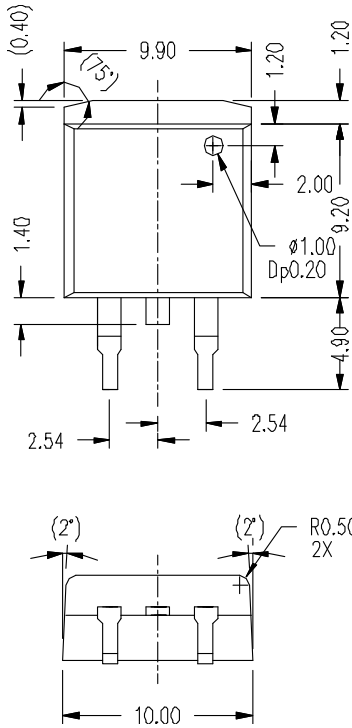
NOTE:

1. These dimensions do not include mold protusion.
2. () is reference dimension only.

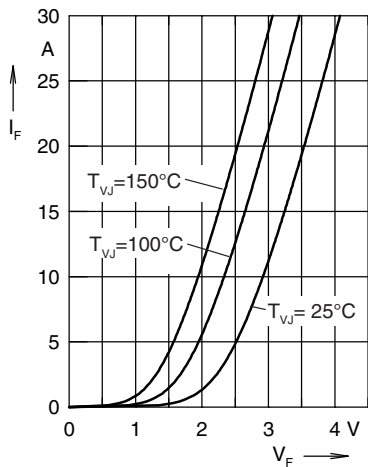

Fig. 1 Forward current I_F versus V_F

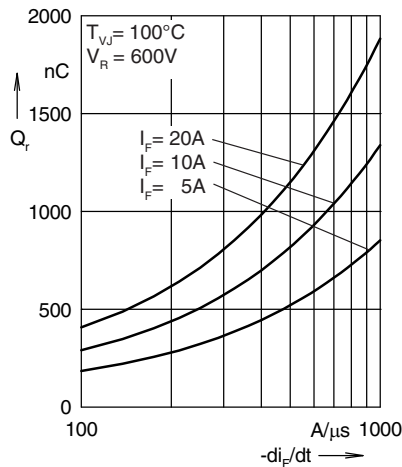

Fig. 2 Reverse recovery charge Q_r versus $-di_F/dt$

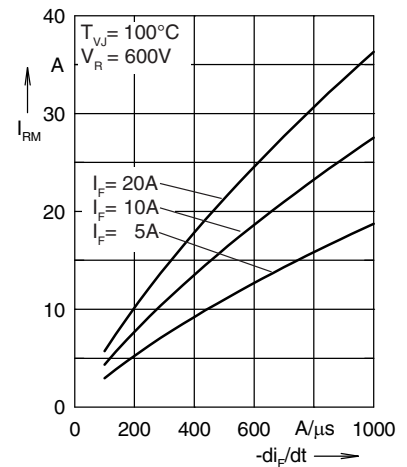

Fig. 3 Peak reverse current I_{RM} versus $-di_F/dt$

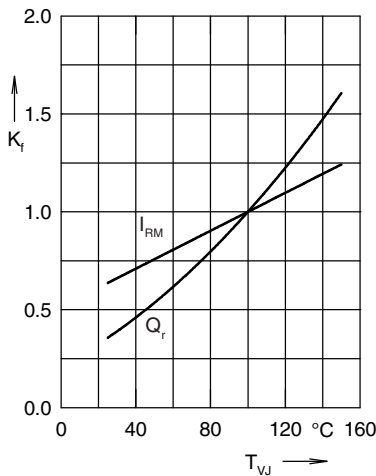

Fig. 4 Dynamic parameters Q_r , I_{RM} versus T_{VJ}

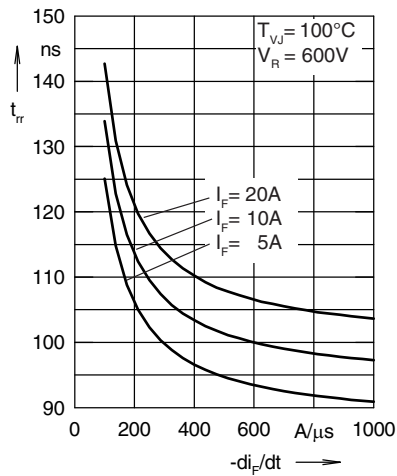

Fig. 5 Recovery time t_{rr} versus $-di_F/dt$

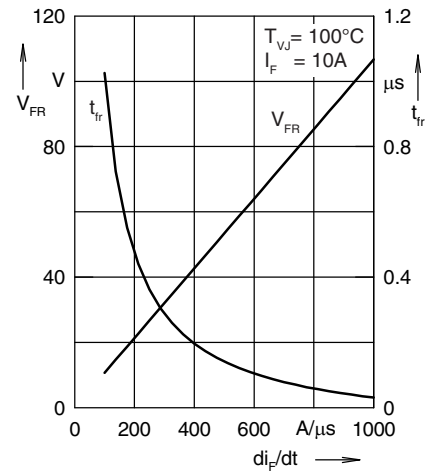

Fig. 6 Peak forward voltage V_{FR} and t_{tr} versus di_F/dt

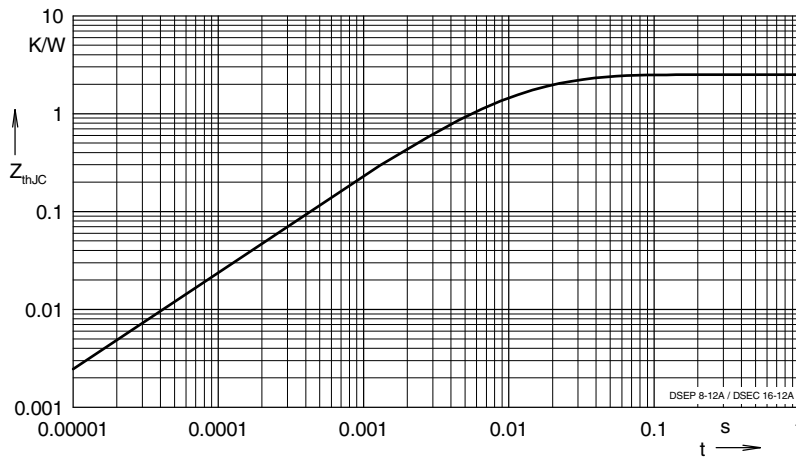

Fig. 7 Transient thermal resistance junction to case

Constants for Z_{thJC} calculation:

i	R_{thi} (K/W)	t_i (s)
1	1.449	0.0052
2	0.558	0.0003
3	0.493	0.017