

HiPerFRED²

High Performance Fast Recovery Diode
 Low Loss and Soft Recovery
 Common Cathode

$V_{RRM} = 400\text{ V}$
 $I_{FAV} = 2 \times 10\text{ A}$
 $t_{rr} = 45\text{ ns}$

Part number
DPG 20 C 400 PC

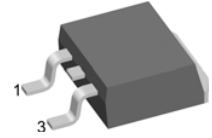
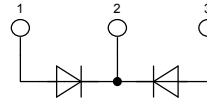

Backside: cathode

Features / Advantages:

- Planar passivated chips
- Very low leakage current
- Very short recovery time
- Improved thermal behaviour
- Very low I_{RM} -values
- Very soft recovery behaviour
- Avalanche voltage rated for reliable operation
- Soft reverse recovery for low EMI/RFI
- Low I_{RM} reduces:
 - Power dissipation within the diode
 - Turn-on loss in the commutating switch

Applications:

- Antiparallel diode for high frequency switching devices
- Antisaturation diode
- Snubber diode
- Free wheeling diode
- Rectifiers in switch mode power supplies (SMPS)
- Uninterruptible power supplies (UPS)

Package:

- Housing: TO-263 (D2Pak)
- Industry standard outline
- Epoxy meets UL 94V-0
- RoHS compliant

Symbol	Definition	Conditions	Ratings			Unit
			min.	typ.	max.	
V_{RRM}	max. repetitive reverse voltage				400	V
I_R	reverse current	$V_R = 400\text{ V}$			1	μA
		$V_R = 400\text{ V}$			0.15	mA
V_F	forward voltage	$I_F = 10\text{ A}$			1.32	V
		$I_F = 20\text{ A}$			1.51	V
		$I_F = 10\text{ A}$			1.03	V
		$I_F = 20\text{ A}$			1.24	V
I_{FAV}	average forward current	rectangular d = 0.5			10	A
V_{FO}	threshold voltage	} for power loss calculation only			0.77	V
r_F	slope resistance				19.8	m Ω
R_{thJC}	thermal resistance junction to case				2.30	K/W
T_{VJ}	virtual junction temperature		-55		175	$^{\circ}\text{C}$
P_{tot}	total power dissipation				65	W
I_{FSM}	max. forward surge current	t = 10 ms (50 Hz), sine			150	A
I_{RM}	max. reverse recovery current				4	A
		$I_F = 10\text{ A}; V_R = 270\text{ V}$			6	A
t_{rr}	reverse recovery time	-di _F /dt = 200 A/ μs			45	ns
					65	ns
C_J	junction capacitance	$V_R = 200\text{ V}; f = 1\text{ MHz}$			12	pF

Symbol	Definition	Conditions	Ratings			Unit
			min.	typ.	max.	
I_{RMS}	RMS current	per pin ¹⁾			35	A
R_{thCH}	thermal resistance case to heatsink			0.25		K/W
T_{stg}	storage temperature		-55		150	°C
Weight				2		g
F_c	mounting force with clip		20		60	N

¹⁾ I_{RMS} is typically limited by: 1. pin-to-chip resistance; or by 2. current capability of the chip.
 In case of 1, a common cathode/anode configuration and a non-isolated backside, the whole current capability can be used by connecting the backside.

Product Marking

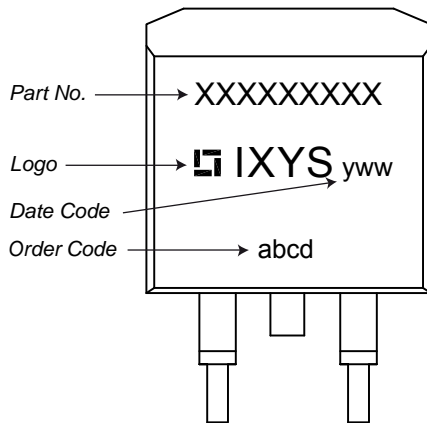

Part number

- D = Diode
- P = HiPerFRED
- G = extreme fast
- 20 = Current Rating [A]
- C = Common Cathode
- 400 = Reverse Voltage [V]
- PC = TO-263AB (D2Pak) (2)

Ordering	Part Name	Marking on Product	Delivering Mode	Base Qty	Code Key
Standard	DPG 20 C 400 PC	DPG20C400PC	Tape & Reel	800	507327

Similar Part	Package	Voltage Class
DPG20C400PB	TO-220AB (3)	400
DPG20C400PN	TO-220ABFP (3)	400

Outlines TO-263 (D2Pak)

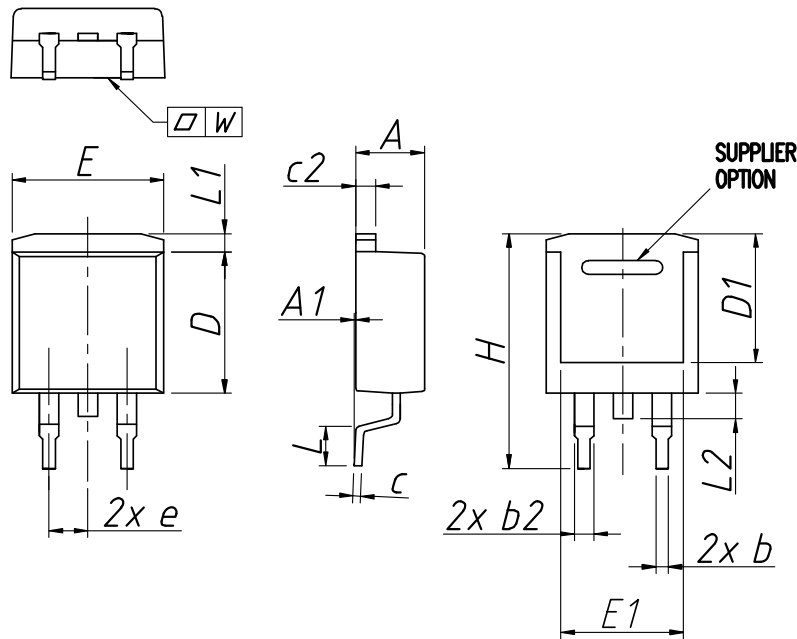

Dim.	Millimeter		Inches	
	min	max	min	max
A	4.06	4.83	0.160	0.190
A1	typ. 0.10		typ. 0.004	
b	0.51	0.99	0.020	0.039
b2	1.14	1.40	0.045	0.055
c	0.40	0.74	0.016	0.029
c2	1.14	1.40	0.045	0.029
D	8.38	9.40	0.330	0.370
D1	8.00	8.89	0.315	0.350
E	9.65	10.41	0.380	0.410
E1	6.22	8.20	0.245	0.323
e	2,54 BSC		0,100 BSC	
H	14.61	15.88	0.575	0.625
L	1.78	2.79	0.070	0.110
L1	1.02	1.68	0.040	0.066
L2	1.02	1.52	0.040	0.060
W	typ. 0.02	0.040	typ. 0.0008	0.0016

All dimensions conform with and/or are within JEDEC standard.

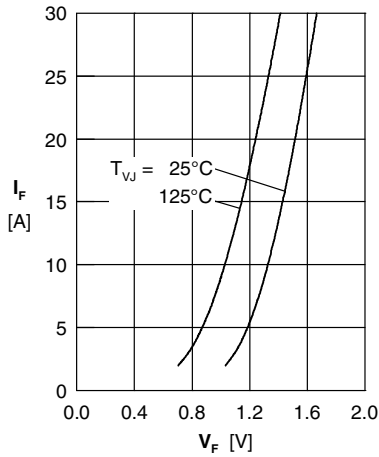

Fig. 1 Forward current I_F versus forward voltage drop V_F

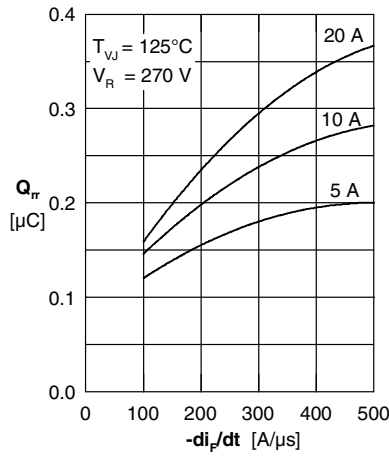

Fig. 2 Typ. reverse recovery charge Q_{rr} versus $-di_F/dt$

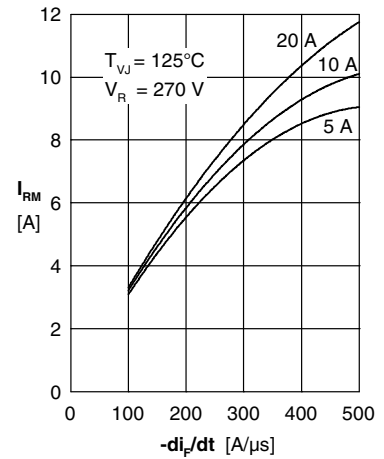

Fig. 3 Typ. reverse recovery current I_{RM} versus $-di_F/dt$

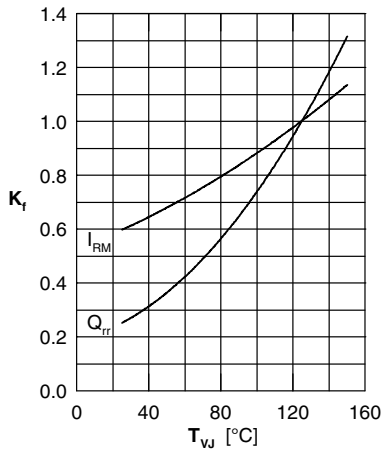

Fig. 4 Dynamic parameters Q_{rr} , I_{RM} versus T_{VJ}

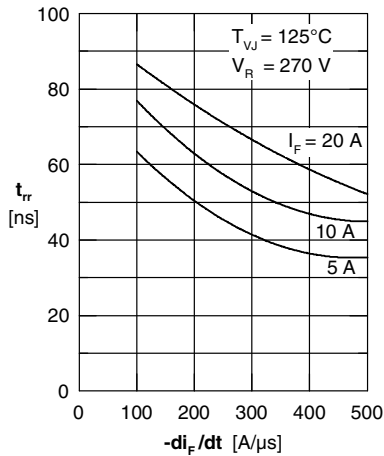

Fig. 5 Typ. reverse recovery time t_{rr} versus $-di_F/dt$

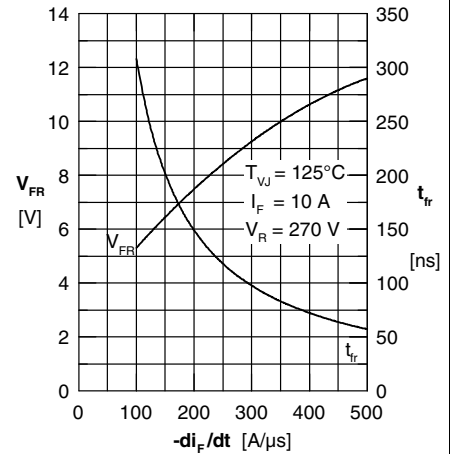

Fig. 6 Typ. forward recovery voltage V_{FR} and t_{fr} versus di_F/dt

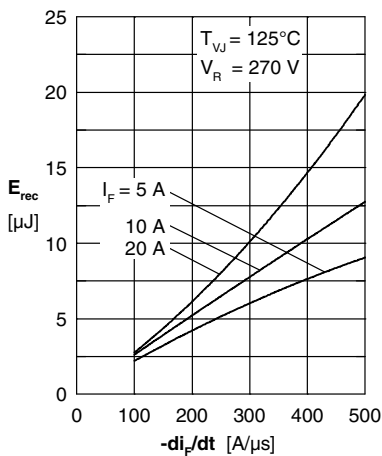

Fig. 7 Typ. recovery energy E_{rec} versus $-di_F/dt$

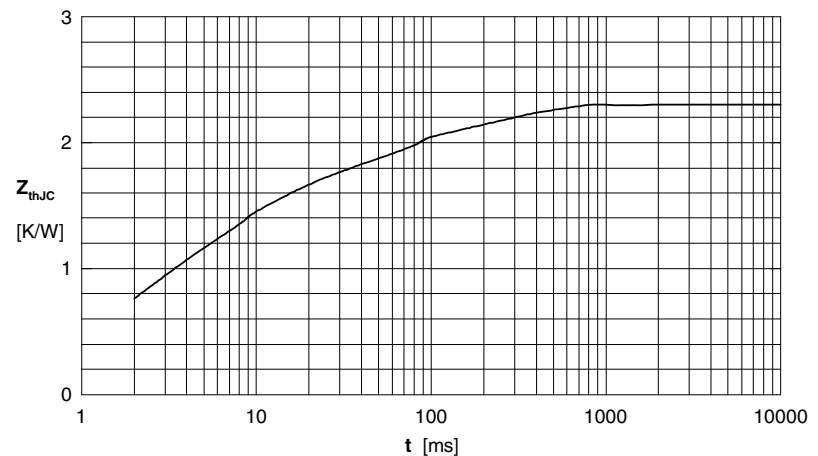

Fig. 8 Transient thermal resistance junction to case