

IGBT Modules

XPT IGBT

$$I_{C80} = 450 \text{ A}$$

$$V_{CES} = 1200 \text{ V}$$

$$V_{CE(sat) \text{ typ.}} = 2.0 \text{ V}$$

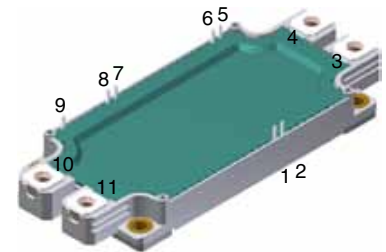
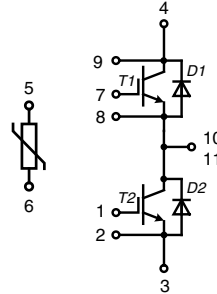

IGBTs			
Symbol	Conditions	Maximum Ratings	
V_{CES}	$T_{VJ} = 25^{\circ}\text{C}$ to 125°C	1200	V
V_{GES}		± 20	V
I_{C80}	$T_C = 80^{\circ}\text{C}$	450	A
RBSOA	$R_G = 1.6 \Omega$; $T_{VJ} = 125^{\circ}\text{C}$ Clamped inductive load; $L = 100 \mu\text{H}$	$I_{CM} = 900$ $V_{CEK} \leq V_{CES}$	A
t_{SC} (SCSOA)	$V_{CE} = 900 \text{ V}$; $V_{GE} = \pm 15 \text{ V}$; $R_G = 1.6 \Omega$ $T_{VJ} = 125^{\circ}\text{C}$; non-repetitive; $V_{CEmax} \leq V_{CES}$	10	μs
P_{tot}	$T_C = 25^{\circ}\text{C}$	2.2	KW

Features

- XPT IGBT technology
- low saturation voltage
- low switching losses
- square RBSOA, no latch up
- high short circuit capability
- positive temperature coefficient for easy paralleling
- MOS input, voltage controlled
- ultra fast free wheeling diodes
- solderable pins for PCB mounting
- package with copper base plate

Advantages

- space savings
- reduced protection circuits
- package designed for wave soldering

Typical Applications

- AC motor control
- AC servo and robot drives
- power supplies

Symbol	Conditions	Characteristic Values			
		$(T_{VJ} = 25^{\circ}\text{C}$, unless otherwise specified)			
		min.	typ.	max.	
$V_{CE(sat)}$	$I_C = 450 \text{ A}$; $V_{GE} = 15 \text{ V}$				
			$T_{VJ} = 25^{\circ}\text{C}$ 2.0	2.2	V
			$T_{VJ} = 125^{\circ}\text{C}$ 2.3		V
$V_{GE(th)}$	$I_C = 18 \text{ mA}$; $V_{GE} = V_{CE}$	5.4		6.5	V
I_{CES}	$V_{CE} = V_{CES}$; $V_{GE} = 0 \text{ V}$				
			$T_{VJ} = 25^{\circ}\text{C}$ 0.1	1	mA
			$T_{VJ} = 125^{\circ}\text{C}$ 6		mA
I_{GES}	$V_{CE} = 0 \text{ V}$; $V_{GE} = \pm 20 \text{ V}$			1.5	μA
$t_{d(on)}$	Inductive load, $T_{VJ} = 125^{\circ}\text{C}$ $V_{CE} = 600 \text{ V}$; $I_C = 450 \text{ A}$ $V_{GE} = \pm 15 \text{ V}$; $R_G = 1.6 \Omega$		70		ns
t_r			40		ns
$t_{d(off)}$			250		ns
t_f			100		ns
E_{on}			42		mJ
E_{off}			48		mJ
Q_{Gon}	$V_{CE} = 600 \text{ V}$; $V_{GE} = 15 \text{ V}$; $I_C = 450 \text{ A}$		1.5		μC
R_{thJC}				0.057	K/W

Diodes			
Symbol	Conditions	Maximum Ratings	
I_{F80}	$T_C = 80^\circ\text{C}$	450	A
I_{FRM}	$t_p = 1 \text{ ms}$	900	A
I^2t	$T_{VJ} = 125^\circ\text{C}; t = 10 \text{ ms}; V_R = 0 \text{ V}$	35000	A^2s

Symbol	Conditions	Characteristic Values			
		$(T_{VJ} = 25^\circ\text{C}, \text{ unless otherwise specified})$			
		min.	typ.	max.	
V_F	$I_F = 450 \text{ A}; V_{GE} = 0 \text{ V}; T_{VJ} = 25^\circ\text{C}$			2.3	V
I_{RM}	$I_F = 450 \text{ A}; di_F/dt = 3500 \text{ A}/\mu\text{s}; T_{VJ} = 125^\circ\text{C}; V_R = 800 \text{ V}$		200		A
R_{thJC}			0.075		K/W

Temperature Sensor NTC					
Symbol	Conditions	Characteristic Values			
		min.	typ.	max.	
R_{25}	$T = 25^\circ\text{C}$	4.75	5.0	5.25	$\text{k}\Omega$
$B_{25/50}$			3375		K

Module			
Symbol	Conditions	Maximum Ratings	
T_{VJ}	operating	-40...+125	$^\circ\text{C}$
T_{JM}		+150	$^\circ\text{C}$
T_{stg}		-40...+125	$^\circ\text{C}$
V_{ISO}	$I_{ISO} \leq 1 \text{ mA}; 50/60 \text{ Hz}$	3400	V~
M_d	Mounting torque (M5)	3 - 6	Nm
	Terminal connection torque (M6)	3 - 6	Nm

Symbol	Conditions	Characteristic Values			
		min.	typ.	max.	
$R_{therm-chip}^*)$	Resistance terminal to chip		0.55		$\text{m}\Omega$
R_{thCH}	with heatsink compound		0.03		K/W
Weight			350		g

*) $V = V_{CEsat} + 2x R_{therm-chip} \cdot I_C$ resp. $V = V_F + 2x R \cdot I_F$

Dimensions in mm (1 mm = 0.0394")

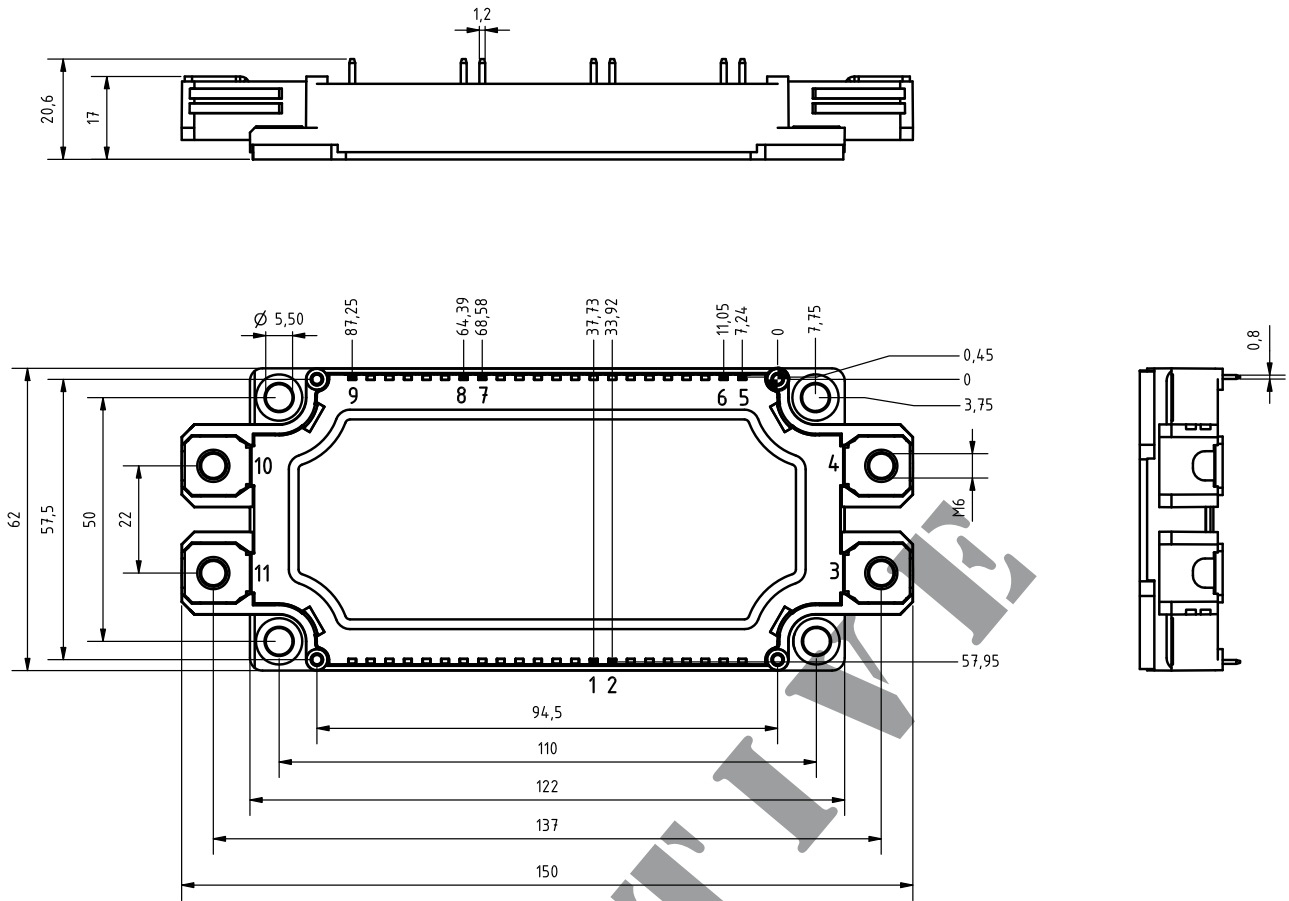

IXYS reserves the right to change limits, test conditions and dimensions.

20100914

© 2010 IXYS All rights reserved

3 - 5

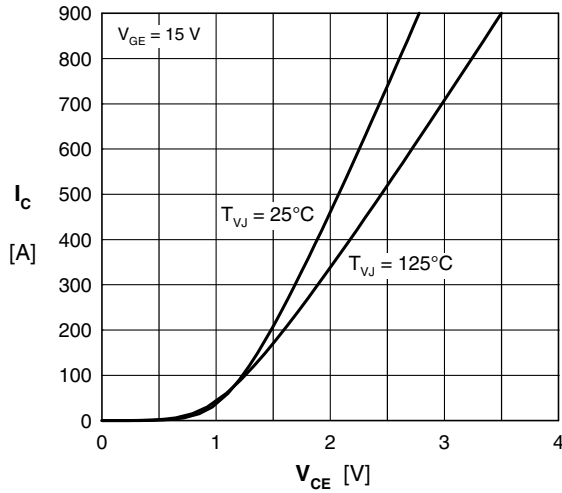

Fig. 1 Typ. output characteristics

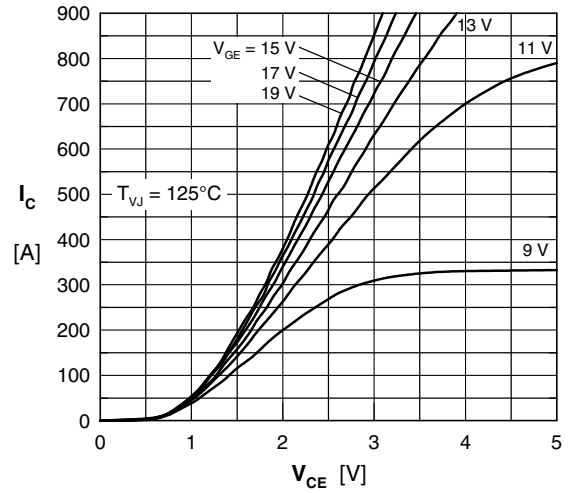

Fig. 2 Typ. output characteristics

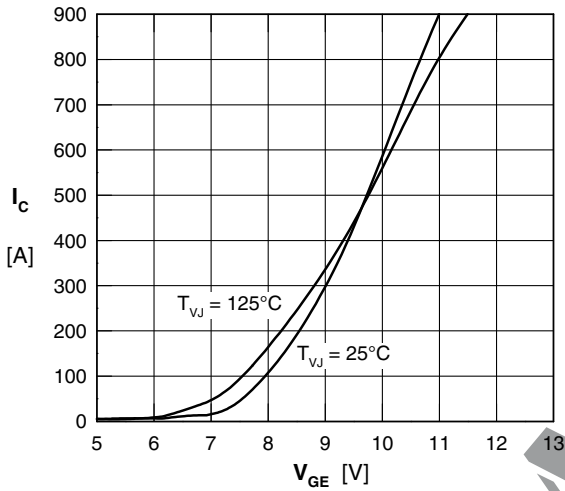

Fig. 3 Typ. transfer characteristics

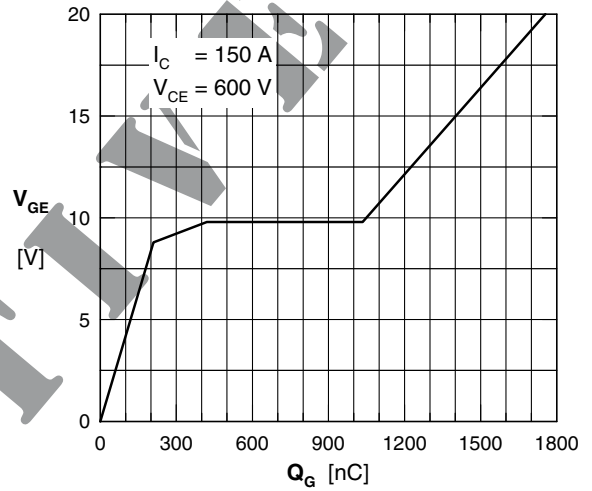

Fig. 4 Typ. turn-on gate charge

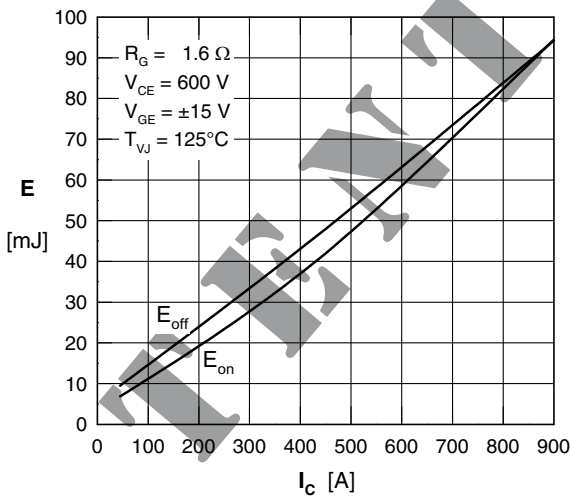

Fig. 5 Typ. switching energy vs. collector current

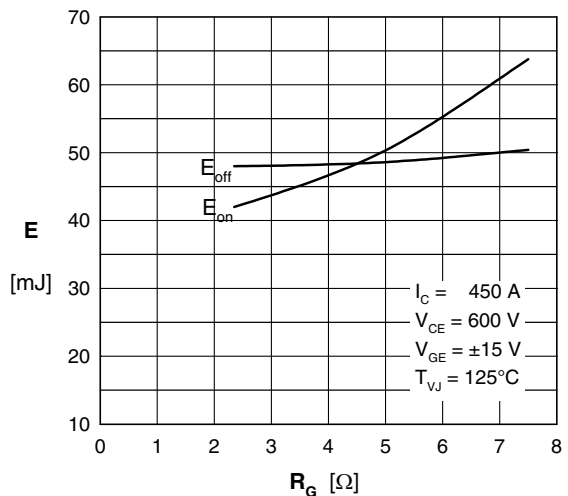

Fig. 6 Typ. switching energy vs. gate resistance

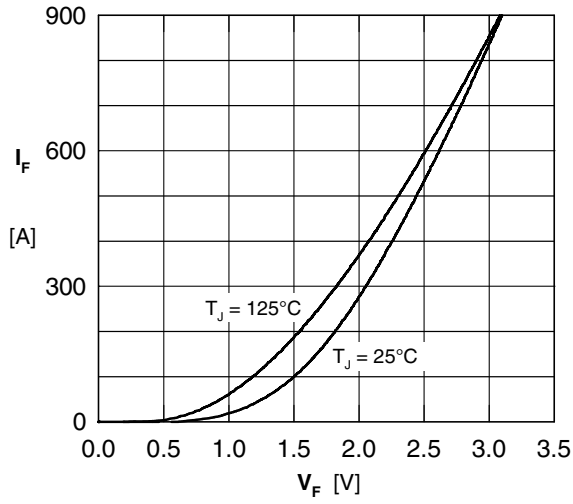

Fig. 7 Typ. forward characteristics of free wheeling diode

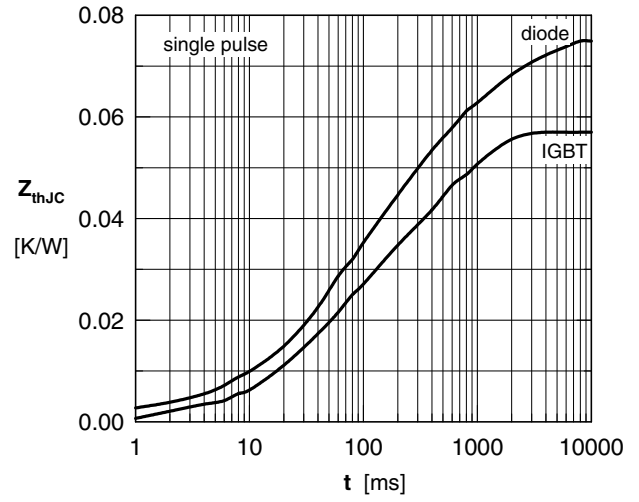

Fig. 8 Typ. transient thermal impedance

TEMPERATURE